

RADIO NEWS

REG. U.S. PAT. OFF.

25 Cents

JULY

Over 200
Illustrations

Edited by HUGO GERNSBACK

RADIO CURRENTS MEASURE PLANT GROWTH

SEE PAGE 22

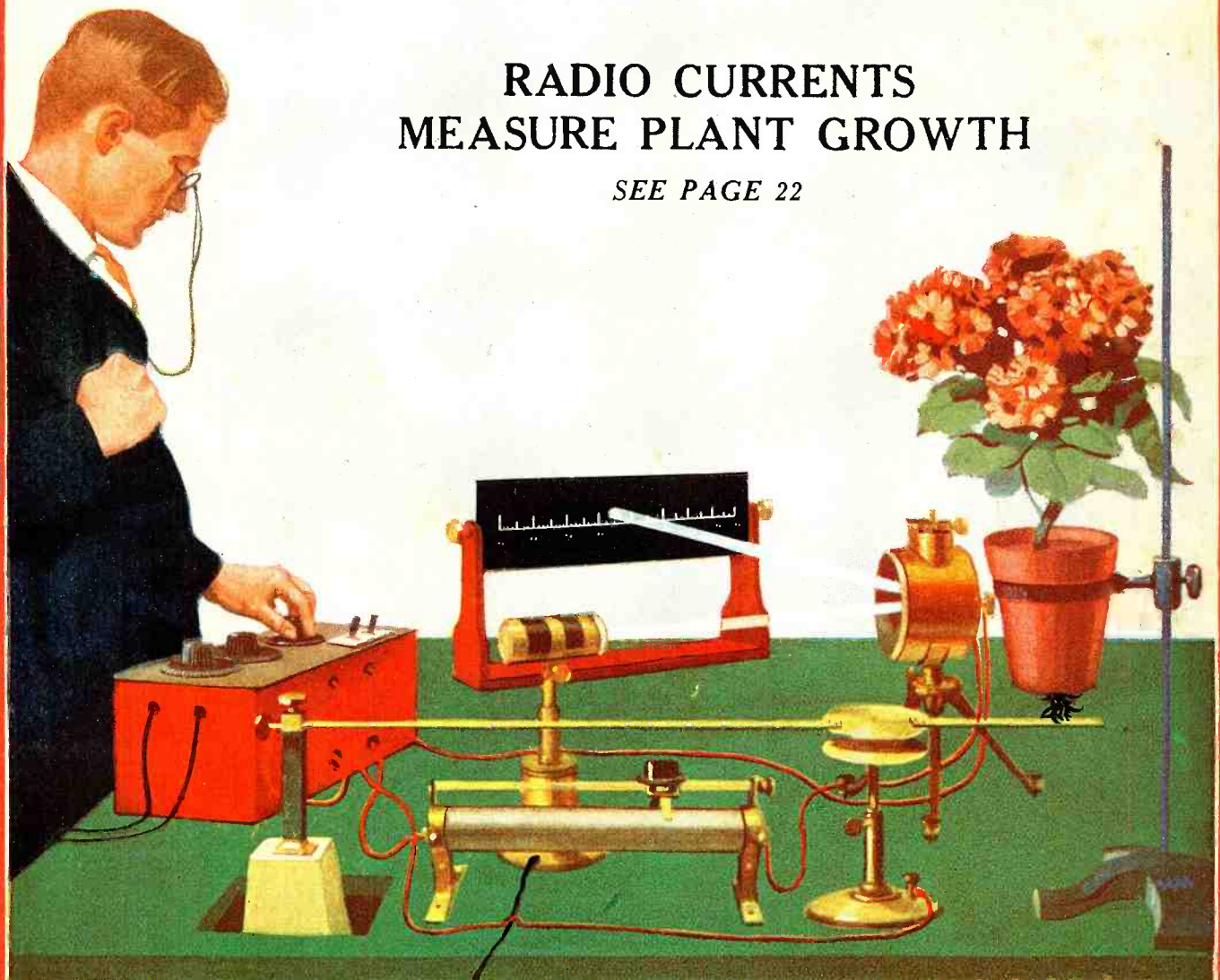

RADIO NEWS' STATION WRNY NOW BROADCASTS RADIO HOOK-UPS

SEE PAGE 62

RADIO'S GREATEST MAGAZINE

EXPERIMENTER PUBLISHING COMPANY, NEW YORK, PUBLISHERS OF

SCIENCE and INVENTION

THE EXPERIMENTER

MOTOR CAMPER & TOURIST

Cunningham RADIO TUBES

Since 1915—
Standard for all Sets

Types C-301A : C-299 : C-300 : C-11 : C-12

In the orange
and blue carton
Price \$3.00 Each



**Sensitive as a Bare Nerve
Delicate as a Spider's Web
Enduring as the Brute**

A single inferior tube in any socket of your receiver and you might just as well try to get a resonant, clear-ringing tone from a cracked bell.

When you neglect the tube, you endanger the entire performance of your set. In millions of American homes—where radio rules supreme—perfect reception is made a certainty by Cunningham Radio Tubes.

Home Office:
182 Second Street
San Francisco

E. J. Cunningham, Inc.

Chicago
New York

Patent Notice: Cunningham Tubes are covered by patents dated 2-18-12, 12-30-13, 10-23-17, 10-23-17, and others issued and pending.

Tower

The
Greatest Values
in Radio History

The Tower Meistersinger Loud Speaker represents the heart's desire of every radio enthusiast who is satisfied with nothing less than the *best*. Equipped with the famous Tower adjustable unit, the wonderful tone quality is amplified to the maximum degree without distortion through the full throated goose neck and scientifically proportioned bell. An object of beauty, the Tower Meistersinger, with soft tone golden lacquer base and dark mahogany finish bell, is *the outstanding value in radio today*.

On sale at all good Radio Dealers.



\$15⁰⁰

The
Meistersinger
Speaker

(The Greatest Singer)

\$3.95

TOWER SCIENTIFIC
PHONOGRAPH ATTACHMENT



\$4.95

LITTLE SPITFIRE
LOUD SPEAKER



\$2.95

TOWER
SCIENTIFIC
HEAD-SET



\$8.50

TOWER
SCIENTIFIC
LOUD SPEAKER

THE TOWER MFG. CORPORATION
98 BROOKLINE AVE
BOSTON MASS

WORLD'S GREATEST LOUDSPEAKER VALUES

RADIO NEWS

Published by EXPERIMENTER PUBLISHING COMPANY, INC.
 Publishers of "Radio News," "Science and Invention,"
 "The Experimenter" and "Motor Camper & Tourist."
 Editorial and General Offices: 53 Park Pl., New York City
 H. GERNSBACK, President. S. GERNSBACK, Treasurer
 R. W. DEMOTT, Secretary.
 MEMBER: AUDIT BUREAU OF CIRCULATIONS

VOLUME 7

CONTENTS

JULY, 1925

NUMBER 1

In Our Next Issue

The Piezo Electric Oscillograph, by Prof. C. B. Bazzoni, tells how the amateur may construct simply this usually complicated piece of apparatus. One of the most interesting articles RADIO NEWS has had the pleasure of publishing.

The \$15,000 Radio Shower Contest will be announced in the next issue. This is something new in the contest field and promises to be extremely interesting. Don't miss it!

Static and Weather Forecasting, by S. R. Winters, will open another new field in the use of radio. This is a recent development of Government investigators.

Mr. Sylvan Harris will give a complete and detailed discussion of the design and construction of the latest advance in variable condenser construction and design. The possibilities of this condenser should interest every set builder and owner.

A New Automatic Tickler Control which simplifies the operation of regenerative sets will be completely described.

In This Issue

Editorial	By Hugo Gernsback	15	Activities of RADIO NEWS Laboratories	By The Director	50
Radio Goes To The North Pole	By John L. Reinartz	16	About Grid Leaks	Francis R. Ehle	51
Experts Discuss Broadcasting On 150 Meters		18	History of Radio Inventions	By A. H. Morse	52
The "Thermion" Vacuumless Tube	By H. G. Silbersdorff	19	All About Verniers	By Sylvan Harris	54
The Inventions of Reginald A. Fessenden		20	Further Notes on "B" Battery Eliminator from Standard Parts	By Donald E. Learned	57
New Uses for the Vacuum Tube	By C. B. Bazzoni	22	A Simply Constructed Wavemeter	By Joseph Riley	58
110-Volt Vacuum Tube	By G. C. B. Rowe	25	A Resistance Coupled Amplifier	By Fred A. Parsons	59
The Life and Work of Lee DeForest		26	The Radio Beginner—Your Radio Set and Your Vacation	By A. P. Peck	60
What Is Low-Loss?	By Sylvan Harris	28	Circuitgrams Broadcast By WRNY	By Hugo Gernsback	62
When Charging Batteries—Think!	By David E. Shetron	29	With The Amateurs		64
A Three-Range Receiver	By Laboratory Staff of RADIO NEWS	30	A Study of Reactance	By Sylvan Harris	66
The Juice Hangs High (A Story)	By Robert Francis Smith	41	A 40-Meter Transmitter With a Punch	By William H. Schick	68
International Radio		42	Standard Hook-ups		69
Esperanto Lessons	By James Deason Sayers	43	Radiotics		71
The Hoyt Augmentor Circuit		44	Correspondence From Readers		72
Single Control	By Sidney E. Finkelstein	46	Awards of the \$50 Radio Wrinkle Contest		73
Needed Radio Inventions	By Jay Hollander	48	New Radio Patents	By John B. Brady	75
A Non-Radiating R. F. Receiver	By Laboratory Staff of RADIO NEWS	49	RADIO NEWS Laboratories		76
			I Want To Know		78

Index to Advertisers 4

RADIO NEWS is published on the 10th of each preceding month. There are 12 numbers per year. Subscription price is \$2.50 a year in U. S. and possessions, Canada and foreign countries, \$3.00 a year. U. S. Coin as well as U. S. Stamps accepted (no foreign coins or stamps). Single copies, 25 cents each. A sample copy will be sent gratis on request. Checks and money orders should be drawn to order of EXPERIMENTER PUBLISHING CO., INC.

All communications and contributions to this journal should be addressed to Editor, RADIO NEWS, 53 Park Place, New York, N. Y. Unaccepted contributions cannot be returned unless full postage has been included. All accepted contributions are paid for on publication. A special rate is paid for novel experiments; good photographs accompanying them are highly desirable.

RADIO NEWS, Monthly. Entered as second class matter, July 12, 1923, at the Post Office at New York, N. Y., under the Act of March 3, 1879. Additional entry at Long Island City, N. Y., Chicago, Ill., Los Angeles and San Francisco, Calif. Title registered U. S. Patent Office. Copyright, 1925, by E. P. Co., Inc., New York. The Experimenter Publishing Co., 53 Park Place, New York. The Contents of this magazine are copyrighted and must not be reproduced without giving full credit to the publication. Copyright in Germany. Reproduction of articles in Germany is reserved for Radio, Berlin 42.

New York City
 General Advertising Dept.
 53 Park Place

Western Advertising Representatives
 Finucan & McClure
 720 Cass St., Chicago, Ill.

Pacific Coast Advertising Representatives
 A. J. Norris Hill Co.
 Hearst Bldg., San Francisco, Calif.

Kansas City Advertising Representative
 George F. Dillon
 Republic Building, Kansas City, Mo.

New England Advertising Representative
 T. F. Magrane, Park Square Building, Boston, Mass.

RADIO NEWS is for sale at all newsstands in the United States and Canada, also at The International News Co., Ltd., Bream's Building, London, E. C. 4, England, and at Brentano's, 37 Avenue de l'Opera, Paris.

HOW TO SUBSCRIBE FOR RADIO NEWS. Send your name, address and remittance to Experimenter Publishing Co., 53 Park Place, New York. Mention the name of the magazine you are ordering. We also publish SCIENCE AND INVENTION, the EXPERIMENTER and MOTOR CAMPER & TOURIST. Write clearly. RATES AND TERMS. The subscription rate for RADIO NEWS is \$2.50 per year (12 numbers). When remitting do so by check, money order, or registered letter if cash is enclosed. Avoid sending cash through the mail if possible. Subscriptions for less than one year are not accepted. Subscription may be made in combination with SCIENCE AND INVENTION or the EXPERIMENTER.

POSTAGE. We prepay postage in all parts of the United States, Mexico and island possessions. For foreign or Canadian subscriptions we require 50 cents in addition to the subscription price for additional postage charges.

CHANGE OF ADDRESS. Notify us as far in advance as possible. It requires several weeks to make an address change on our records. Always write clearly.

ON EXPIRATION of your subscription we enclose a renewal blank in our last number to you; we stop our delivery to you on expiration.

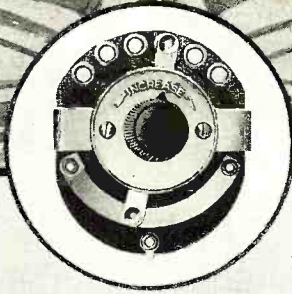

Grebe
Volume
Control

Controlling Audio Amplification in a New Way

WITH the Synchronphase, volume is controlled by an exclusive feature which makes possible six graduations of volume without changing the character of the sound. This is done gradually and not by the abrupt and distorting stage-to-stage method common to most receivers.

Sound can thus be modulated at will to please the ear.

*Ask your dealer to demonstrate
this and other Grebe features*

A. H. GREBE & CO., Inc.

Van Wyck Blvd., Richmond Hill, N. Y.

Western Branch: 443 So. San Pedro Street, Los Angeles, Cal.

THE GREBE

*This company owns
and operates station
WAHG*

SYNCHROPHASE

— TRADE MARK —



Exclusiveness is
a virtue only as
it benefits others.

Doctor M. J.



All Grebe apparatus is covered by patents granted and pending.

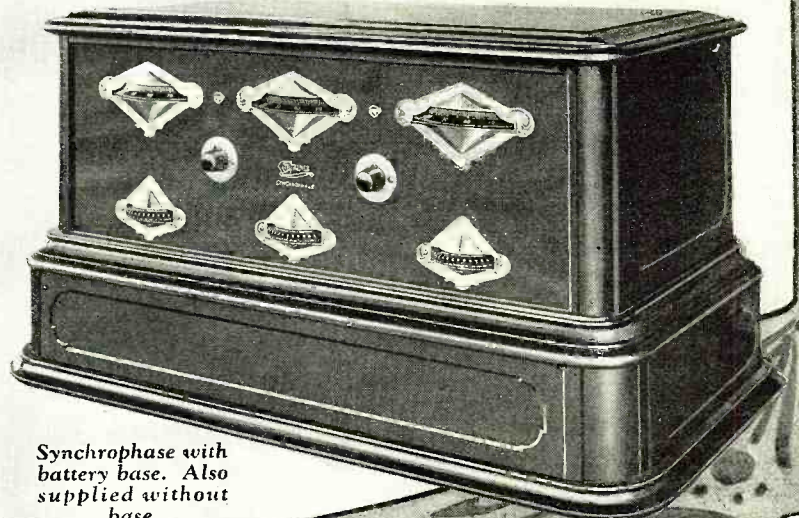

*Synchronphase with
battery base. Also
supplied without
base.*

INDEX TO ADVERTISERS

	Page		Page		Page
A		D		K	
Aeme Apparatus Co.	87	D. N. Instrument Co.	117	Johnson, Smith & Co.	104
Alden Mfg. Co.	82	Daven Radio Corp.	114	Jones Radio Mfg. Co., Inc.,	
All-American Radio Corp.	111	Dayton Fan & Motor Co., The	92	Jos. W.,	121
Allen-Bradley Co.	128	Diamond Elec. Specialties Corp.	116	L	
American Bosch Magneto		Dubilier Condenser & Radio		Lancaster & Allwine.	106
Corp.	82-116	Corp.	107	Lincoln Mfg. Co.	84
American Electric Co.	120	Duplex Condenser & Radio		M	
American Hard Rubber Co. ..	84	Corp., The	88	M & M Co., The.	117
American Radio Ass'n.	120	E		Marshall Electric Co.	90
Amplion Corporation of Amer-		E. I. Company	96-110	Midwest Radio Co.	125
ica, The	106	E-Z Toon Radio Co.	106	Miller Rubber Co. of New	
Amsco Products, Inc.	90-106 101	Eagle Radio Co.	88	York, The	104
Andrews Radio Co.	109	Electrical Research Labs., Inc.	93	Mozart Grand Company, The.	100
Arnley Radio Corp.	111	Electric Service Supplies Co. ..	90	Murdock Co., Wm. J.	116
Arrow Battery Co.	90	Electric Specialty Co.	119	Music Master Corporation.	88
Atwater Kent Mfg. Co.	97	Elgin Radio Supply Co.	123	Mydar Radiob Company.	104
Automatic Electrical Devices		Elite Stationery Co.	90	N	
Co., The	90	Erie Fixture Supply Co.	121	Nagel Electric Co., The.	86
B		Evans & Co., Victor J.	100	National Airphone Corp.	10-11
Bakelite Corporation	117	F		National Carbon Co., Inc.	83
Barkeley Elec. Mfg. Co., The..	86	Fahnestock Electric Co.	110	National Radio Institute, The...	5
Biltmore Radio Co.	102	Fansteel Products Co., Inc.	85	Neodyne Associates	96
Black Bros., Inc.	100	Ferbend Electric Co.	104	O	
Bluebird Tube Co.	86	Field & Co., Geo.	104	Ohio Radio Sales.	92
Bodine Electric Co.	125	Formica Insulation Co., The..	89	Omnigraph Mfg. Co., The.	117
Boice, W. B. & J. E.	98	Freshman Co., Inc., Chas.	86-100	Owen, Richard B.	106
Brady, John B.	116	Frost, Inc., Herbert H.	123	Ozarka, Inc.	14
Breakers, The	111	G		P	
Bremer-Tully Mfg. Co.	119	Gem Tube Co.	120	Pacent Electric Co., Inc.	114
Bristol Co., The	90	Gould Storage Battery Co.	100	Parker, C. L.	86
Broadway Temple	103	Grebe & Co., Inc., A. H.	3	Phenix Radio Corporation.	99
Brownlie, Roland	109	H		Precision Coil Co., Inc.	94
C		Hammarlund Mfg. Co.	94	Prest-O-Lite Co., Inc., The.	95
California Radio Minerals.	90	Harvard Radio Laboratories.	116	Providence Distributing Co.	125
Carter Radio Co.	120	Hayden Co., A. C.	94	R	
Chemical Institute of New		Heath Radio & Elec. Mfg. Co. ..	84	Radar Mfg. Co.	129
York, Inc.	7	Hommel & Co., Ludwig.	84	Radiall Co.	98
Chicago Electric Devices Co. ..	88	Hudson-Ross	92-96-111-119	Radio Association of America.	115
Chicago Salvage Stock Store. ..	88	I		Radio Chart Bureau.	92
Cleveland Eng. Labs. Co., The	115	International Correspondence		Radio Corporation of America ..	81
Colytt Laboratories	98	Schools	96	Radiogem Corporation, The.	101
Consrad Company, Inc., The,		J		Radio Industries Corp.	8-9
98-105-112-122-127		Jefferson Electric Mfg. Co.	117-125	X Y Z	
Continental Fibre Co., The.	82	Jewell Elec. Instrument Co.	92	X L Radio Labs.	100
Coyne Electrical School.	119	K		Y. M. C. A. Radio Institute.	106
Crescent Braid Co., Inc.	92	Johnson, Smith & Co.	104	Zenith Radio Corporation.	
Crescent Radio Supply Co.	121	Jones Radio Mfg. Co., Inc.,		Inside Back Cover	
Crosley Radio Corporation, The	91	Jos. W.,	121	S	
Cruver Mfg. Co.	92	L		Radio Parts Co.	107
Cunningham, Inc., E. T.,		Lancaster & Allwine.	106	Radio Specialty Co.,	
Inside Front Cover		Lincoln Mfg. Co.	84	12-13-82-98-104-110-113-120	
Cutler-Hammer Mfg. Co., The,		M		Radio Tube Exchange.	94
Back Cover		M & M Co., The.	117	Radio Units, Inc.	116
D		Marshall Electric Co.	90	Randolph & Co.	106
D. N. Instrument Co.	117	Midwest Radio Co.	125	Rice & Hochster.	123
Daven Radio Corp.	114	Miller Rubber Co. of New		Richardson Radio, Inc.	100
Dayton Fan & Motor Co., The	92	York, The	104	Riker, Dave	115
Diamond Elec. Specialties Corp.	116	Mozart Grand Company, The.	100	Roice Tube Co.	110
Dubilier Condenser & Radio		Murdock Co., Wm. J.	116	T	
Corp.	107	Music Master Corporation.	88	Telephone Maintenance Co.	95
Duplex Condenser & Radio		Mydar Radiob Company.	104	Tork Co.	88
Corp., The	88	N		Tower Mfg. Corp.	1
E		Nagel Electric Co., The.	86	U	
E. I. Company	96-110	National Airphone Corp.	10-11	U. S. Tool Co., Inc.	109
E-Z Toon Radio Co.	106	National Carbon Co., Inc.	83	Uncle Sam Electric Co.	98-120
Eagle Radio Co.	88	National Radio Institute, The...	5	V	
Electrical Research Labs., Inc.	93	Neodyne Associates	96	Valley Electric Co.	98
Electric Service Supplies Co. ..	90	O		Vesco Radio Co.	100
Electric Specialty Co.	119	Ohio Radio Sales.	92	W	
Elgin Radio Supply Co.	123	Omnigraph Mfg. Co., The.	117	Waage, A. H.	115
Elite Stationery Co.	90	Owen, Richard B.	106	Wade Mfg. Co.	115
Erie Fixture Supply Co.	121	Ozarka, Inc.	14	Walbert Mfg. Co.	84-94-114
Evans & Co., Victor J.	100	P		Washburn Burner Corp., The.	102
F		Pacent Electric Co., Inc.	114	Western Radio Mfg. Co.	92
Fahnestock Electric Co.	110	Parker, C. L.	86	Weston Elec. Instrument Corp.	88
Fansteel Products Co., Inc.	85	Phenix Radio Corporation.	99	Wills & Co., N. L.	110
Ferbend Electric Co.	104	Precision Coil Co., Inc.	94	World Battery Co.	102-114
Field & Co., Geo.	104	Prest-O-Lite Co., Inc., The.	95	X Y Z	
Formica Insulation Co., The..	89	Providence Distributing Co.	125	X L Radio Labs.	100
Freshman Co., Inc., Chas.	86-100	R		Y. M. C. A. Radio Institute.	106
Frost, Inc., Herbert H.	123	Radar Mfg. Co.	129	Zenith Radio Corporation.	
G		Radiall Co.	98	Inside Back Cover	
Gem Tube Co.	120	Radio Association of America.	115	S	
Gould Storage Battery Co.	100	Radio Chart Bureau.	92	Saturn Mfg. & Sales Company.	
Grebe & Co., Inc., A. H.	3	Radio Corporation of America ..	81	Inc., The	109
H		Radiogem Corporation, The.	101	Service Battery Company.	113
Hammarlund Mfg. Co.	94	Radio Industries Corp.	8-9	Shipman Ward Mfg. Co.	102
Harvard Radio Laboratories.	116	S		Silver-Marshall, Inc.	100-121
Hayden Co., A. C.	94	Radio Parts Co.	107	Smith, B. R.	120
Heath Radio & Elec. Mfg. Co. ..	84	Radio Specialty Co.,		Southern Toy Co., The.	114
Hommel & Co., Ludwig.	84	12-13-82-98-104-110-113-120		Spaulding Fibre Company, Inc.	114
Hudson-Ross	92-96-111-119	Radio Tube Exchange.	94	Starrett Mfg. Co.	90
I		Radio Units, Inc.	116	Steger & Sons Piano Mfg. Co.	84
International Correspondence		Randolph & Co.	106	Sterling Mfg. Co., The.	123
Schools	96	Rice & Hochster.	123	Stransky, J. A.	116
J		Richardson Radio, Inc.	100	Super-Booster Distributing Co.	106
Jefferson Electric Mfg. Co.	117-125	Riker, Dave	115	T	
Jewell Elec. Instrument Co.	92	Roice Tube Co.	110	Telephone Maintenance Co.	95



I am averaging anywhere from \$75 to \$150 a month more than I was making before enrolling with you. I would not consider \$10,000 too much for the course.
(Signed) A. N. Long,
Greensburg, Pa.



The N. R. I. course is by far the best. I have made very good money and enjoy myself in the Radio game. A thorough training from the N. R. I. will set any man well on the road to happiness and prosperity in the Radio world.
Lawrence Yanek,
Iowa City, Iowa.

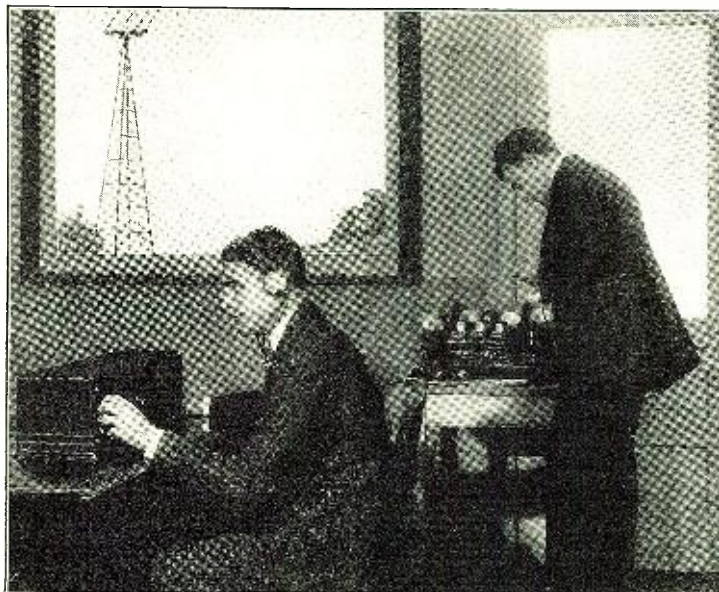

Before I enrolled with you I was making \$15 a week on a farm. Now I earn from \$2,080 to \$1,420 a year. And the work is a hundred times easier than before. Since graduating a little over a year ago, I have earned almost \$1,000 and I believe the course will be worth at least \$100,000 to me.
(Signed) Gen. A. Adams,
Tamaqua, Pa.



I can very easily make double the amount of money now than before I enrolled with you. Your course has benefited me approximately \$5,000 over and above what I would have earned had I not taken it.
T. Winder,
Grand Junction, Col.

Prepare Yourself For Radio — the New Profession

Many N.R.I. Graduates Now Earning From \$5000 to \$20000 a Week

THE biggest, best-paying field open to ambitious men today. Thousands needed at once for pleasant, interesting jobs. High Pay—Short Hours. No experience required. Learn in your spare time at home.

Here is work that is fascinating, new and easy—an industry which is growing more rapidly than any other in the world today—an industry that offers you the chance of a lifetime to “get in on the ground floor” and make big money. Right now, thousands of trained men are needed in all branches of the business. Radio operators, Radio engineers, salesmen, mechanics and Radio executives are scarce and receive wonderful pay. Are you going to shut your eyes to this golden opportunity when there is a quick, easy way to get one of these splendid positions?

You can train for this “big money” field right in your own home—in your spare time. No matter how little you know about electricity or Radio, the National Radio Institute—the largest and best school of its kind in the world—will guarantee to give you a thorough Radio training in a few short months.

Salaries Doubled and Tripled

Since the National Radio Institute was founded in 1914 over 15,000 men and young men have taken this short-cut to

Success in Radio. They are enthusiastic about this wonderful Course.

E. W. Barnes, Norfolk, Va., writes: “During my spare time, I make about as much repairing Radio sets and building them as my regular salary.”

In a letter from Arthur Ruse, of Toronto, we read that he has doubled his income since mastering Radio and that he earns from \$50 to \$100 a month in his spare time.

This page contains only a few of the thousands of letters we receive from successful graduates. Hardly a week goes by without our receiving urgent calls for our graduates. “We need the services of a competent Radio Engineer.”

“We want men with executive ability in addition to Radio knowledge to become our local managers.” “We require the services of several resident demonstrators”—these are just a few small indications of the great variety of opportunities open to our graduates.

This is an absolutely complete Radio Course now being offered

which qualifies you for a Government First Class Commercial License and really gets you the bigger paying jobs in Radio.

Send Today for Free Book and Special Short-time Offer

Don't rely on this announcement for a true picture of the opportunities in Radio. Simply mail the coupon and we will send you a big free book, “Rich Rewards in Radio,” which will show you actual proof of the big money being made by our graduates today. It will describe the course in full detail, it will tell you just how much you can earn in this fascinating profession.

Best of all, you will get the details of our Special Reduced rate which is being offered for a short time. So mail the coupon now! Make this your lucky day!

The National Radio Institute
Dept. 13JB
Washington, D. C.

Study In Your Spare Time At Home

This is the time to go into Radio. Big opportunities are now open in every branch of the work, and salaries were never so high. The thing to do is to begin studying at once, in whatever time you can spare, so that you will be able to qualify for the position you want when the time comes. Only an hour or so every evening will quickly prepare you for Radio—a profession you cannot fail to find fascinating and pleasant. Don't handicap yourself; start at once and advance with the others.

The National Radio Institute,
Dept. 13JB, Washington, D. C.

I am interested in Radio as a profession. You may send me, free and without obligation, your interesting book, “Rich Rewards in Radio,” all information about your spare time, home-study plan and about your free employment service. Also, the details of your Special Offer.

Name Age
Street
City State

RADIO NEWS READERS' BUREAU

Time and Postage Saver

IN every issue of RADIO NEWS you undoubtedly see numerous articles advertised about which you would like to have further information. To sit down and write an individual letter to each of these respective concerns, regarding the article on which you desire information, would be quite a task.

As a special service to our readers, we will write the letters for you, thus saving your time and money.

Just write the names of the products about which you want information, and to avoid error the addresses of the manufacturers, on the coupon below and mail it to us.

If the advertiser requires any money or stamps to be sent to pay the mailing charges on his catalogue or descriptive literature, please be sure to enclose the correct amount with the coupon.

We will transmit to the various advertisers your request for information on their products.

This service will appear regularly every month on this same page in RADIO NEWS.

If there is any Manufacturer not advertising in this month's issue of RADIO NEWS, from whom you would like to receive literature, write his name, address and the product in the special section of the coupon below.



TEAR ALONG THIS LINE

READERS' SERVICE BUREAU,
 Experimenter Publishing Co., Inc., 53 Park Place, New York, N. Y.

RN-7-25

Please advise the firms listed below that I would like to receive detailed information on their product as advertised in the issue of RADIO NEWS.

DO NOT USE THIS COUPON FOR TECHNICAL QUESTIONS

NAME	ADDRESS (Street — City — State)	List here specific article on which you wish literature.	If Catalogue of complete line is wanted, check in this column
.....
.....
.....
.....
.....
.....
.....
.....
.....
.....

Use this space if you desire information from a manufacturer whose advertisement does not appear in this month's issue.

NAME	ADDRESS (Street — City — State)
.....
.....
.....

Your own name here

If you are dealer check here. Address
 City State

CHRISTIANITY ON BROADWAY

Excerpts from editorial in The Daily Reporter, White Plains, N. Y. By W. Livingston Larned

AN unusual project has been set in motion in New York. A "Business Building" is to rise on Broadway, at 173rd Street, dedicated to Christianity. To be known as the "Broadway Temple," it will contain a church, offices, auditoriums, schools, hotel accommodations, cafeterias, etc. And to a large extent, it will be erected by popular subscription. Individuals buy bonds, representing a 5 per cent investment and the total cost will be approximately \$4,000,000.

It is the first undertaking of its kind, and has so many amazing features that we will do well to observe some of these innovations. For this is a combination of church and skyscraper. Business and Christianity will be housed under one roof.

This Broadway Temple is, in a sense, a gigantic symbol of the uncontroversial fact that Godliness can and should be continuous.

Broadway will be the better for a substantial reminder of this Holy Presence. From every vantage point, on sunny days, or nights filled with the sinister menace of storm, a high-flung cross of unquenchable light will be visible, glittering against the heavens. And he will murmur to himself reverently, "The Holy Spirit hides with me wherever I may be, walking or sleeping."

Broadway Temple will cover 26,000 square feet of foundation space, facing a whole block on Broadway. It will have a beautiful tower, 24 stories high; six million people will see a revolving cross of light, 34 feet high, on its topmost pinnacle. The church auditorium will seat 2200; there will be Sunday school rooms, a social hall and every modern convenience for religious and community work. An apartment hotel in the tower is to contain 644 rooms, public offices and dining halls. Apartments for housekeeping in the two wings will accommodate 500 persons. And there are stores fronting on Broadway.

In exploiting this magnificent and ambitious plan, its sponsors say: "A 5 per cent investment in your Fellow Man's Salvation, Broadway Temple is to be a combination of Church and Skyscraper, Religion and Revenue, Salvation and 5 per cent—and the 5 per cent is based on ethical Christian grounds."

Broadway Temple is more than a revolutionary idea, more than a sound investment, more than an architectural wonder of the age; it represents a spiritual stepping stone in man's climb upward to the Cross.

**"Buy These Bonds
and Let God
Come to Broadway"**

Religion and Revenue Glorified by a Wonderful Ideal

The Directors who will conduct this business enterprise, the men with whom you, as an investor, will be associated, are some of the keenest and best-known business men in New York. They are

- President: Ellis L. Phillips,
Pres. Long Island Lighting Co.
- Arthur J. Baldwin, Vice-President
McGraw Hill Publishing Co.
- Carl H. Fowler, Vice-President,
Fowler & Holloway
- Samuel McRoberts, Treasurer,
Chatham & Phoenix Nat'l
Bank & Trust Co.
- W. R. Comfort, President,
Reid Ice Cream Co.
- Charles A. Frueauff,
Frueauff, Robinson & Sloan
- Frank De K. Huyler,
President of Huyler's
- E. V. P. Ritter,
Formerly Pres. Grand Central
Palace
- M. G. Collins, Vice-Pres., Broker
- Watson S. Moore, Vice-President,
Formerly V.P.U.S. Grain Corp.
- Frederick Kraft, Secretary,
Kraft Cheese Co.
- Hon. Royal S. Copeland,
U. S. Senator
- Lamar Hardy,
Former Corporation Counsel
- Robert H. Montgomery,
Lybrand, Ross Bros. & Mont-
gomery
- W. P. Tanner,
W. P. Tanner-Gross Co.

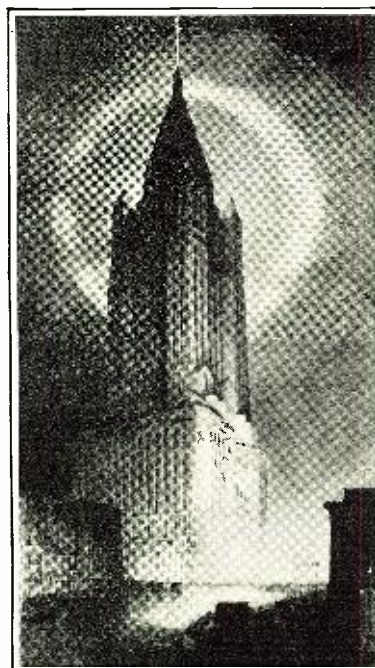

BROADWAY TEMPLE
A Twentieth Century Cathedral, Church,
Hotel, Stores, Apartment House;
Self-Supporting, Community-Serving

Why this is a SAFE Investment

Merely as an investment the Bonds of the Broadway Temple are inviting as a business proposition. Ewing, Bacon & Henry, real estate experts, in a letter to Donn Barber, the architect, set forth the following conservative estimate of income:

Rental from stores	\$27,500
Income from two apartment houses . . .	166,290
Income from apartment hotel	402,300
Total annual income	\$596,090
Total expenses and interest and taxes . .	470,500

Leaving a net surplus for the bond holders of \$125,590 annually

GEN. SAMUEL McROBERTS, Treas.
Chatham & Phoenix National Bank & Trust Co.
149 Broadway, New York City

I hereby subscribe to \$_____ in Broadway Temple Second Mortgage GOLD BONDS, income bearing at the rate of 5% per year. I agree to make payments as follows: 10% of total amount when my subscription is accepted, and 10% every sixty days thereafter until paid in full.

IF YOU WANT DETAILS ONLY, SEND COUPON BELOW

—Before I send in my subscription, please send complete details showing how I may make this investment with safety of principal and interest at 5%.

Name _____

Address _____

City _____ State _____

RICO-DYNE FROM COAST TO COAST RICO-DYNE

SAN FRANCISCO LOS ANGELES ST. LOUIS CHICAGO PITTSBURG NEW YORK

Type B
De Luxe
\$75

Rico-Dyne (radio frequency) De Luxe

FOR THOSE WHO WANT TO BUY ONLY THE COMPLETE RICO-DYNE KIT

Equipped with the famous MELO-TONE unit space for "B" Batteries built in mahogany cabinet

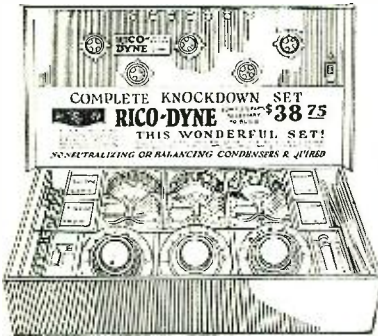

\$38.75

Here is just what you want. The necessary parts to build the famous Ricodyne Receiver.

De Luxe radio frequency receiver, composed of a beautiful, spacious, genuine mahogany cabinet, the famous Rico-Dyne improved, clear-toned receiver and the Melotone, the master reproducing unit—what more could anyone ask?

It's an ideal for your home—a beautiful cabinet—a well-known, reliable set, giving clear tone, plenty of volume, distance at will and long lasting service.

It is the ultimate in new 1925 receivers—the *best* that radio offers. Send for our literature and prices.

\$2.95

The Headset of Real Value

Rico-Fones

“the nation's favorite headset”

Probably the most popular headphones made, 500,000 Rico Fones are serving in every nook and corner of the world. There has never been so much quality put in a headphone at such a small price. For better tuning and distance, use Rico Fones, America's Favorite!

RADIO INDUSTRIES CORP.
 131 Duane Street :: :: :: NEW YORK, N. Y.
 Export (Ricotrade) Cable Address Bently Code Used

DEALERS — JOBBERS — DISTRIBUTORS
Wire immediately for our interesting new sales proposition.

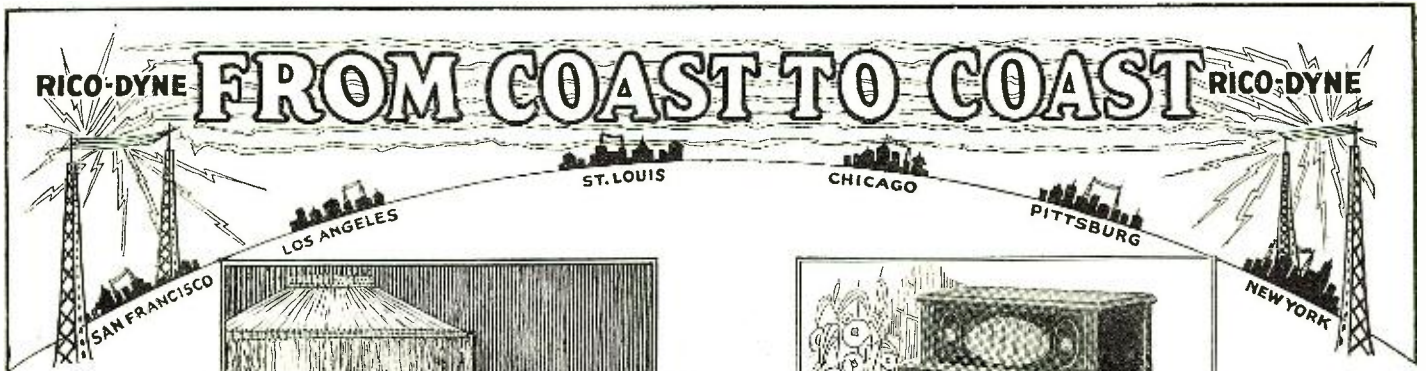

Type A
\$60

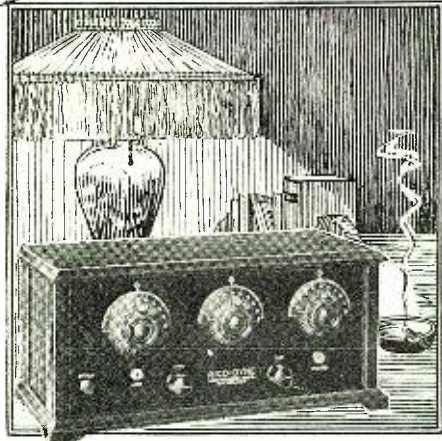

Rico-Dyne—Standard

Marvelous tone, Inexpensive Receiver in solid mahogany cabinet

The combination of Rico Celluweld Low Loss Coils and Variable Condensers is mechanically perfect. The Coils are welded firmly to the support of the rotor plates, a new principle. (Patents Pending.)

Selective and non-oscillating, the Rico "Auto-Balanced" Tuned Radio Frequency Set accomplished by carefully setting the neutralizing angle of the Coils at the factory; remains permanent due to the Celluweld process.

These and other features are all combined to give the radio buyer the very finest in improved 1925 Receivers.

MELOTONE UNIT

Melotone—the perfect reproducing unit—for loud speakers, phonographs, etc.—is a standard Rico product that is guaranteed by the complete success of thousands now in use. Melotone is known throughout the radio trade. It is used everywhere. It has all the qualities of \$10 and \$12 units. **\$7.50**

\$7.50

RADIO INDUSTRIES CORP.

131 Duane Street :: :: :: NEW YORK, N. Y.
Export (Ricotrade) Cable Address Bently Code Used

DEALERS — JOBBERS — DISTRIBUTORS

Wire immediately for our interesting new sales proposition.

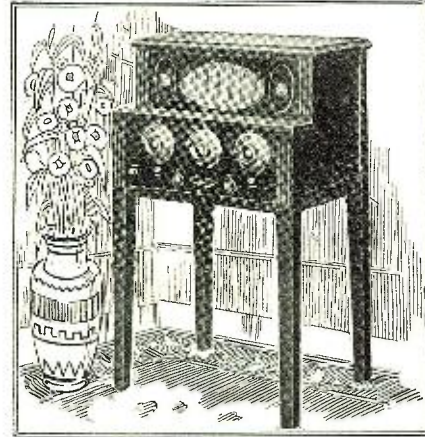

Type C
Console
\$100

Rico-Dyne-Aristocrat

Equipped with MELOTONE unit and space for all batteries—a beautiful piece of furniture for the home

The most recent Rico-Dyne acquisition—a thoroughly finished Receiver for those who desire the best that radio has to offer in the way of quality, appearance and efficiency. The Aristocrat is of solid mahogany—an instrument of grace and beauty.

Equipment: Rico-Dyne auto-balanced receiver, spacious battery compartment, Melotone unit and loud speaker.

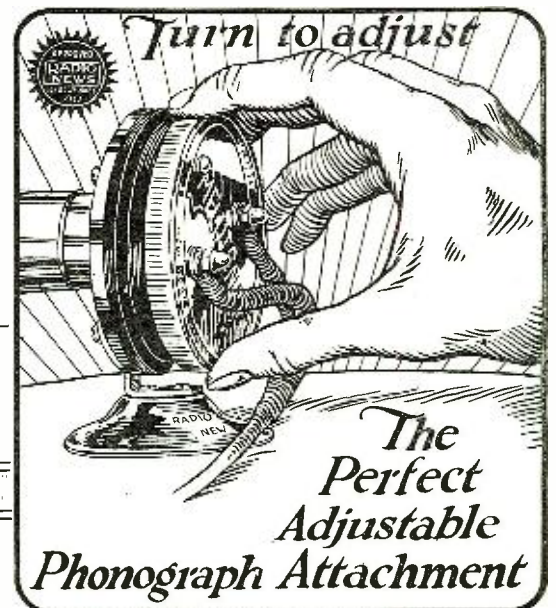



Somerset

1926
MODEL

\$60⁰⁰

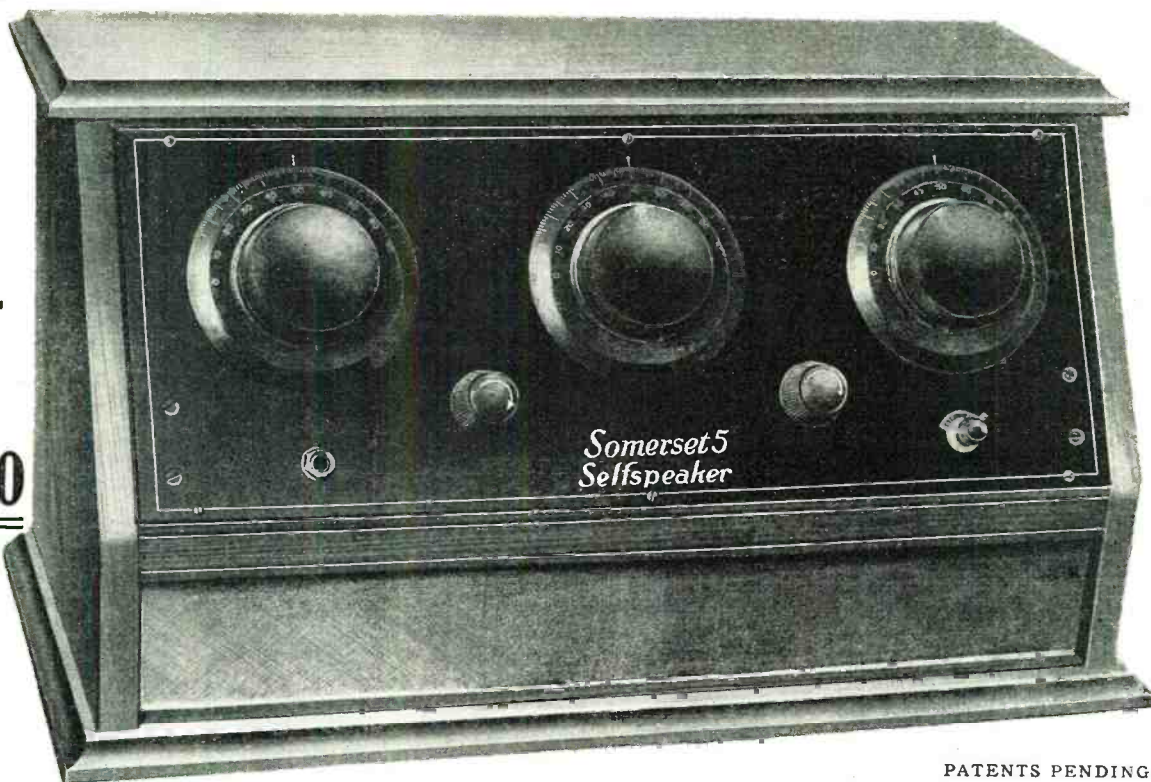

PATENTS PENDING

The Ultimate in radio frequency receivers **Somerset Self-Speaker**

Somerset
Model 5
Self-Speaker

WITH SELF CONTAINED LOUDSPEAKER

There are other radio receivers as good as Somerset but they cost more. There are other radio receivers at the same price as the Somerset—but the quality is lower.

We do not claim to make the best receivers nor the cheapest receivers—for both of these are doubtful distinctions.

But we do believe we are the first to introduce a complete line of distinctively high quality, cabinet-enclosed radio receivers at prices which the average purchaser can afford.

We do believe we are pioneers in the field of honest prices for good design, good material and good workmanship—in the field of full value radio receivers.

TRUTH IN RADIO This is the Somerset policy; to give the radio buying public, so long confused and disappointed by extravagant and misleading claims, the assurance of honest value for every dollar spent.



Self Speaker

Trademark Reg. U. S. Pat. Off.



The only 5 tube Radio Frequency Receiver with self-contained loud speaker

Every now and then someone brings forth an idea of such obvious value that its merit is instantly recognized and everyone wonders why it wasn't done before. This is exactly the reception that has been accorded the SOMERSET SELF SPEAKER—the perfect Tuned Radio Frequency set.

We offer this SOMERSET SELF SPEAKER to the discriminating public, knowing full well the public's demands. This is the only five tube receiving set on the market that is sold as a complete unit including built-in loud speaker. It is the ultimate result of painstaking endeavor to offer something worth while.

Briefly, its specifications cover only standard parts and material: Bakelite Panel fully engraved, condensers of the highest quality—low-loss type—our own calibrated transformers, and only the finest sockets, binding posts, etc. The cabinet is a work of art, beautifully polished and finished in mahogany.

NOTHING cheap about this set—EXCEPT THE PRICE. Never before in the history of Radio has a 5-tube first-class set, with a built-in loud speaker sold at such a low price.

THE PERFECTLY TUNED RADIO FREQUENCY SET

On all these counts—and more—SOMERSET Radio Receivers challenge comparison, feature for feature, with any others at or near their price—bar none.

It needs no argument nor persuasion—every SOMERSET Radio Receiver speaks for itself—a piece of fine furniture enclosing an instrument of super-craftsmanship.

PERFORMANCE

THE new Somerset Self Speaker has a built-in cabinet type loud speaker of an entirely new design. Sounds roll out, not with a nasal tone, but in a clear and correct modulation. **RANGE OF SET**—With this set in New York we have brought in, in poor radio locations, stations 1500 miles away, on the loud speaker. The set tunes extremely sharp, and long-distance stations can be logged while locals are on the air.

BACKED BY THE SOMERSET GUARANTEE

We will cheerfully and promptly make good any SOMERSET SELF SPEAKER which does not fully measure up to the purchaser's expectations of quality and value. This guarantee means exactly what it says, without reservations.

EASY SELLING FEATURES

Every woman recognizes at sight the superior lines and finish of SOMERSET cabinets. They're distinctive in their rich hand rubbed mahogany finish—an artistic addition to any drawing room. The receiver is worthy of this fine setting, finest of materials and parts, superior workmanship and finish, painstaking care in the little details which mean so much in results.

NATIONAL AIRPHONE CORPORATION
18 Hudson Street, New York City

Without any obligation to me, send full details and information on the Somerset line and remarkable Dealer Service.

Name

Address

City

Prices subject to change without notice.

MAIL TODAY FOR PROFIT PAY

You wouldn't pass by money that would be yours for the picking up—don't pass up this chance to earn of profit opportunity.—Fill out and mail Coupon NOW.

NATIONAL AIRPHONE CORP

Manufacturers of Somerset Radio Receivers

18 HUDSON STREET, N. Y. CITY

Prices West of the Mississippi—add 10%

© 1925 National Airphone Corp.

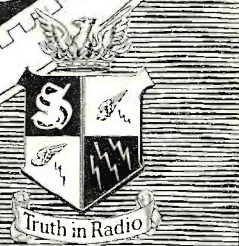

PRICES SLASHED FOR QUICK ACTION!

To get you started dealing with us, we have slashed the prices on these most popular four kits. But your order will have to be sent by July 31 when our regular catalog prices will again be in effect. Look at the list prices—then our low catalog prices—then see the big cut we have made to give you an inducement to order quick!

Your chance to get the best kit at a big saving! Take it!

All of our Kits contain complete parts for receiver, including drilled and engraved Bakelite-Dilecto panel, finest, roomy mahogany finish cabinet, simple new-style blueprint and instructions, everything—nothing more to buy. All parts highest grade—advertised, well-known, reliable, dependable—fully guaranteed by manufacturers and

ourselves. Look at these brands: Bakelite-Dilecto, Sickles, Gen-Win, Hammarlund, X-Lab, Amplex, Chelton, Bakelite, E-Z Toon, Patent, Amperite, Amsco, Bell, Carter, Improved, Smilear, Bradley, Electrad, Hilco, Dubilier, and the like, which we give you. You cannot get better kits anywhere than here!

Our New Method of Wiring—Perfectly Simple—No Radio Knowledge Needed

No solder—No bare wires—No poor connections—No dissatisfaction.
No tools needed except a common screw-driver and common pliers.



All connections are made by the use of our flexible, insulated eyeletted connecting wire in place of bus bar or wire, and solder. And in a fraction of the time usually required when using the old fashioned way. And when the job is done it is neat and your connections are tight.

4-Tube Roberts Knock-Out

Superior to most other sets REGARDLESS OF NUMBER OF TUBES!

Spl. \$43⁵⁰ Postpaid Kit Z K 9215 Range 3500 Miles

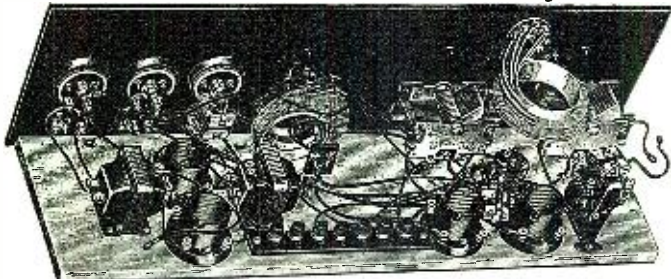

Combines principles of Reflex, Neutralization, Tuned Radio Frequency, Regeneration (without blooping), and Push-Pull Amplification. Smooth-working—easily tuned—non-howling—non-squealing—non-reradiative. Guaranteed absolutely to give entire satisfaction.

See what Doubleday, Page & Co. through Mr. Arthur H. Lynch, Editor of their magazine, "Radio Broadcast," say about the Radio Broadcast's sensational 4-Tube Knock-Out Set developed by Walter Van B. Roberts: "Tube for tube, dollar for dollar, result for result, we will stack it up against any receiver for home construction ever described by any radio publication and gamble that it comes out winner."

MR. LYNCH ADDS—READ IT!

"It is the best we have ever seen—and we have seen and operated almost every type made and used during the past twelve years. It has pulled in forty-six stations on a loud speaker with two tubes, using an indoor antenna. Its signals have been heard through the air more than a quarter mile. It is not merely the best four-tube receiver, but the best by a very good margin."

CUSTOMERS PRAISE IT!

"The set is all that is claimed." "Selectivity is better than that of my 8-tube super-heterodyne." "I get the distant stations with the same clarity and volume as the local stations!" "It is a wonder in sensitivity, good volume, ease of tuning and tone quality." "I have followed the development of the Roberts circuit with results far beyond all expectations. I was skeptical as to the unusual operation that it was said to have accomplished. Recently I have received KGO four times. Once I received it on my Dictogrand loud speaker, using only two tubes!"

Received Europe in recent transatlantic tests. The set you have been hoping for! List price, \$64.69; our regular catalog price, \$48.50—Special price to July 31, only \$43.50.

6-Tube Tropadyne Super Radio

Very popular. Many desirable features. Set has received London.

Spl. \$56⁵⁰ Postpaid Kit Z K 4477 Range 3500 Miles

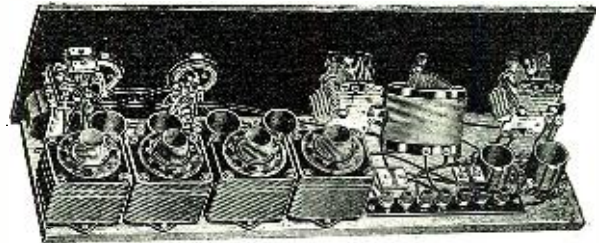

Superior to Standard Super-Heterodyne

This wonderful 6-Tube Set brings in Station KFKX (Hastings, Nebraska), 1200 miles away, in New York City, clearly on a loud speaker, using only a small loop aerial.

Special Features: Only six tubes, but equal to many sets of 8 to 10 tubes—Selectivity is unusual, cuts through local stations—Maximum sharpness—Only two dials—Maximum volume—Does not radiate—Tuned intermediate transformers—Easy to construct—Simple to operate—Great clarity—Permanent logging of stations—Receives on loop aerial—Long distance on loud speaker.

Read This Expert Testimony: "Permit me to say I prefer the Tropadyne to anything I have ever used, and I have been in the game nearly three years, and have assembled, used or repaired at least a dozen different circuits, including some of the better-known factory sets. With one stage of audio, on a loop, the volume is fully equal to a five-tube neutrodyne using a long aerial. I have noticed that static does not seem to be amplified at all in the radio frequency stages, which is surprising to me, since I had thought that static disturbances would be amplified in any type of transformer, radio or audio. I have, however, found that even on the same aerial the Tropadyne does not amplify static as much as a four-tube tuned radio frequency set, using two stages audio." M. F. Adams, Post Office Building, Eatonton, Georgia.

Your money refunded if this set does not satisfy you in all respects—If you do not declare the Tropadyne to be the best radio set you have ever heard. List price, \$69.24; our catalog price, \$60.50—Special Price to July 31, only \$56.50.

3-Tube LoLos \$26⁵⁰ Postpaid—Kit Z K 6996 Explorer—Spl. Range 1000 Miles on Loud Speaker

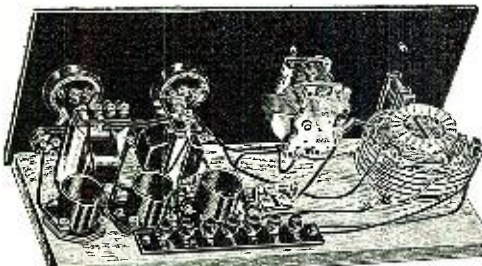

Positively a "hummer!" We have never tested an outfit at anywhere near our price more suitable for long distance broadcast reception. Contains a low loss 3-circuit tuner, a low loss condenser, low loss sockets, etc. **Special Features:** Sensitive—Selective—Clear reception—Simple to construct—Simple to operate—Dependable—Low loss design—Receives 10 mg. distances—Great volume. Stations logged on "LoLos Explorer" in 2 hours at New York

City by one of the editors of "Radio News," all on Loud Speaker: WJZ, WEAF, WBBH, WQAO, WJY, WGBS, WHN, New York City; WFAM, St. Cloud, Minn.; WBBH, KYW, Chicago; KDKA, East Pittsburg, Pa.; WTAS, Elain, Jh.; WTAX, Cleveland; WIT, Philadelphia; WOC, Davenport, Iowa. List price for parts, \$37.51. Our catalog price, \$30.25. Special Price to July 31st, only \$26.50.

1-Tube Single Circuit—Special \$10⁵⁰ Postpaid Kit Z K 9182 Range 1500 Miles

Has many advantages over other types. Just right for one who wants a set to learn with without having to invest very many dollars. Think of the low cost. Probably the most popular circuit. Simple to construct with our "No-Sod-a" connecting wires. You can do it in a half hour or so. Look at the picture. See how few wires. Simplest to operate. Receives up to 1,500 miles in favorable conditions. Sweet tone. Plenty of volume. This offer as well as all of our offers of Kits includes a nice, roomy cabinet. Order this Kit and let us become acquainted. You will be pleased. Shipped on approval, no money in advance. List price, \$18.49; our catalog price, \$11.79—Special Price to July 31, only \$10.50.

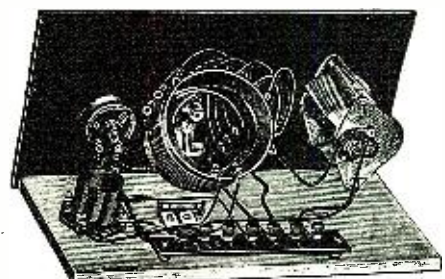

BE SURE TO SEE THE OPPOSITE PAGE FOR NEW "RASCO" GOODS

ORDER DIRECT FROM THIS AD
No Money in Advance—Shipped on Approval—We Pay Transportation—24-Hour Shipment—Satisfaction or Money Back.
Send for CATALOG—36 pages, 7x10—FREE
Filled with big bargains in Kits, Parts and Accessories.
You need it. Send today!

WE SHIP IN 24 HOURS Satisfaction Guaranteed

RADIO SPECIALTY CO., Kit Div. 679H, 245 Greenwich St., N.Y.

"BUILD YOUR OWN" WITH "RASCO" PARTS!

Buy from the Oldest and Original Exclusive Radio Parts House in the United States

We pay ALL transportation charges in U. S. ALL GOODS SENT PREPAID IN 24 HOURS

Order direct from this page.

SPECIAL PRICES FOR JULY

Money refunded if goods do not satisfy

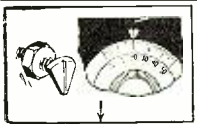

Dial Marker
The big little thing you have been waiting for. Just drill a hole in the panel and mount the marker above the dial. Nickel plated and polished. L788 Dial Marker, three for\$1.10

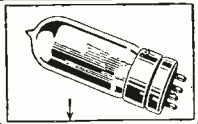

Vacuum Tubes
Only best make tubes carried in stock. Any tube replaced if defective, providing filament lights.
SPECIAL PRICE
L701A 5 v., 25 amp. \$1.95
L790 3 v., .06 amp. 1.95
L720 1 1/2 v., 25 amp. 1.95
L6699 Melotone..... \$6.90

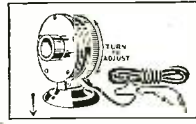

Melotone Loud Speaker
The greatest and most powerful loud speaker phonograph attachment made. If, after five days trial, you do not proclaim it the best and most powerful speaker return it for refund.
L6699 Melotone..... \$6.90

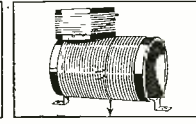

Cockaday Coil
Guaranteed best make. Three windings of No. 18 Magnet wire. Has brass brackets for panel or brass mounting. Satisfaction guaranteed or money back.
L2750 Cockaday coil \$1.50

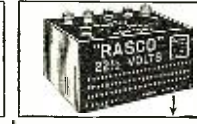

Tapped "B" Batteries
We positively guarantee these batteries to be of long life. We carry only fresh stocks. All with taps.
L2250 Sm. 2 1/2 v.\$.85
L2251 Medium Navy size, 2 1/2 v.1.20
L4500 Medium large size, 45 volt2.30

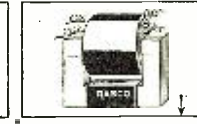

Audio Frequency Transformer
No better Transformer made. Highest class materials. Impregnated coils. Silicon steel stampings used. Save 50 per cent by assembling it yourself.
L1106 Ratio 4 1/2-1. \$1.85
L1150 Ratio 6 1/2-1. 1.85

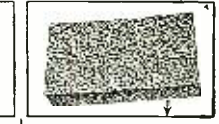

Sponge-Rubber Cushions
Get rid of tube noises due to vibration. Softest sponge rubber made. Size 2 1/2"x3", 3/8" thick.
L8989 Sponge-rubber cushions, each\$1.12
Six for60

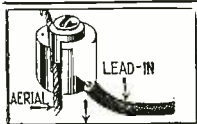

Antenna Connector
At last the solderless antenna connector, made entirely of brass in three pieces; clamps aerial and lead-in with vise-like grip, keeping perfect contact at all times. Dia. 9/16", height 1/2".
L9994 Connector.....\$0.20

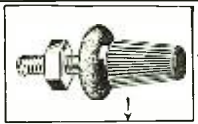

Rasco Vernier
Why use a vernier condenser when a vernier attachment will do anything and everything a vernier condenser accomplishes? Cleverest vernier made. Can be used with any dial. Soft rubber ring engages dial. Nothing to come apart.
L1450 Vernier\$1.18

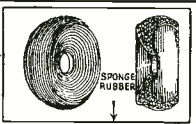

FONEKUSHIONS
Made of sponge rubber. Make wearing your receivers a pleasure. Positively exclude all noises and make reception a pleasure. Sponge rubber will last for years. Light as a feather.
L3550 Fonekushions, set of two\$1.38



Dial Button
Made in blue enamel and gold, to be worn in button hole. Every radio fan wants one. 3/8" diameter, best mold plate. Perfect reproduction of radio dial.
L7799 Dial Button, each\$0.25

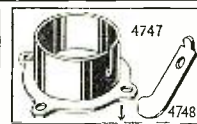

Vacuum Tube Shell
Nickel plated shell for the man who builds his own. 4 holes to attach to sub-base. Each shell comes complete with 4 phosphor bronze socket contacts. See illus. 4748.
L4747 Vacuum Tube Shell and Contacts\$0.16

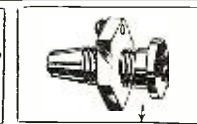

Cord Tip Jack
Takes place of binding posts. Cord tip firmly gripped by jack. Made of brass, nickel plated. Screw to attach lead wire. No soldering necessary.
L1500 Cord tip jack, each\$1.15

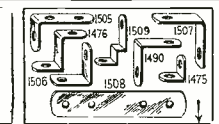

Brass Nickelated Brackets
All illustrations 1/4 size.
L1505 Bracket, each \$0.05
L1507 Bracket, each .05
L1569 Bracket, each .04
L1476 Bracket, each .05
L1506 Bracket, each .05
L1490 Bracket, each .04
L1475 Bracket, each .03
L1508 Bracket, each .05

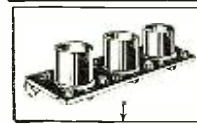

Three-Gang Socket
Aluminum shells, genuine heavy bakelite base. 3 brackets for mounting. 12 nickel binding posts. Length 7 1/4".
L3995 3 gang socket \$1.50

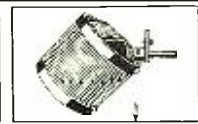

Rasco 180° Variocoupler
Silk wire wound on bakelite tubes. Six taps. Wave length, 150 to 600 meters. For panel mounting. 3/4" shaft. Your money refunded if it is not all we claim.
L3100 Variocoupler pre-paid\$1.50

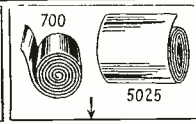

Copper Ribbon
.005" thick.
L700 3/4" wide; L701 1/2" wide; L702 3-16" wide. All sizes per foot.\$0.10
Copper Foil
.001" thick. 4" wide.
L5025 Copper Foil, per foot\$1.10
10-foot length60

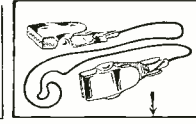

Rasco Clip Leads
Invaluable for experimental work. Clip lead hooks in a jiffy onto any wire, binding post or conductor. Safest experimental connection. Brass clips. 1 foot silk wire, green or red.
L7887 Clip Leads, ea. \$1.12
Dozen lot1.35



Radio Frequency Transformers
Best Radio Frequency Transformer developed so far. Designed by R. E. Laeault, Inventor of Uradyma. Air core type. 200-600 meters.
L2800 Transformer, size 1 1/2"x2 1/2"\$1.35



PUSH-PULL Transformer
Push Pull Transformer for many new circuits. See any radio magazine. Made of best materials. Coils impregnated. Silicon steel laminations. Save 50 per cent by assembling yourself. Simple instructions furnished.
L1159 Push-Pull Transformer, ratio 6 1/2 to 1 \$3.40

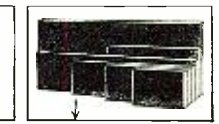

Dielectric Panels
Highest dielectric strength as per Bureau of Standards. Beautiful high finish.
L7100 7x10x3-16" ..\$.70
L7120 7x12x3-16" .. .85
L7140 7x18x3-16" .. .95
L7180 7x18x3-16" ..1.25
L7210 7x21x3-16" ..1.45
L7240 7x21x3-16" ..1.65

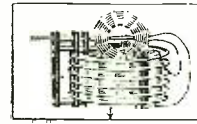

Low Loss Tuner
Same type as used in our L O L O S EXPLORER. Tunes from 200 to 600 meters. Hard rubber insulation throughout. Silver plated primary. Secondary D. C. C. Ticker silk insulated wire.
L2690 Tuner\$5.00



"T" Wire Connectors
This big little article solves all troubles when making "T" wire connections. Made to take 1/16" square or round bus-bar wire. Can be attached with a pair of pliers.
L2975 "T" Wire Connectors, 12 for.....\$0.05

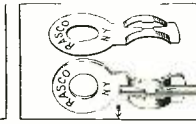

Nosolder Lugs
Finally, a real solderless lug is here. Soldering positively done away with. Takes square or round bus-bar, which it holds with a vise-like grip. Perfect connection. Just slide bus-bar into slot.
L3727 Lug, 25 for.....\$1.15



Low Loss Coil
Same type coil as used in Freshman and other Tuned Radio Frequency sets. D. C. C. wire, 200-550 wave length. 2" diameter, 1" wide, 5-16" thick, 4 connections, 2 primary, 2 secondary.
L2029 Low Loss Coil 85¢

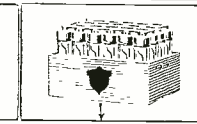

Storage "B" Battery
48 volts. 4 1/2 amp. hours. Buy storage "B" batteries by capacity, not by looks. Charge lasts one month. Rubber tops and vents, wooden tray. Sent Express Collect.
L4480 Storage "B" Battery\$14.00

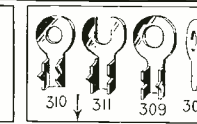

Tinned Nickel Lugs
All our lugs are tinned. L316 Brass Lugs for No. 3 screw, doz.\$1.10
L311 Copper Lugs for Nos. 4 and 8 screws, doz. \$1.60
L309 Copper Lugs for Nos. 1, 6 and 8 screws, doz. \$1.60
L308 Copper Lug for 6-32 screw, doz.10

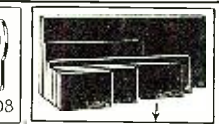

Formica Panels Clearance Sale
As we are discontinuing these particular sizes, this material is now offered at cost. All 3-16" thick.
L352 6x12" each\$1.25
L354 6 1/2x9 1/2" ea.1.60
L356 6x11" each1.20
L357 6x4" each45

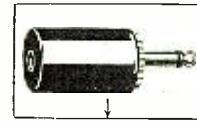

Phone Plugs
Sold from 75¢ to \$1.00 everywhere. Hard rubber composition shell and patented cord tip holder. Finest workmanship throughout.
L1030 Rasco Telephone Plug, Each\$1.35



Bakelite Socket
Octagon shape. Four nickel binding posts, phosphor bronze contact springs. Best brown bakelite.
L6510 Bakelite socket \$1.40
L6500 Tube Socket. Made entirely of composition. Best made. Each\$1.35



Binding Post Name Plates
Dia. 3/4". These styles: Phones, Ground, —, Output, "A" Bat. —, "B" Bat., Loud Speaker, "C" Bat., Aerial, —, Input, "A" Bat., "B" Bat., Loop "C" Bat., —, New! "A" Bat. + "B" Bat. —
L6000 Name Plates, Dozen\$1.25

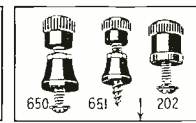

"Rasco" Posts
Made of black composition. L650-51 Each\$1.08
L202 Has nickel-plated bottom, each\$1.08
Dozen, each style.....\$9.90
L122 Initiated Binding Posts. Six popular styles. Each\$1.06

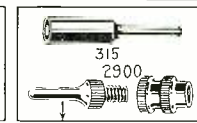

Cord Tips
Standard phone cord tips, nickel. L315 Each\$0.03
Separable Cord Tips
No solder required. Wire loops in ferrule. Nickel holds it tight. L2900 Each\$1.06

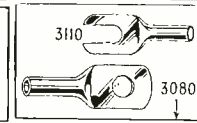

"Perfect" Lugs
These new and improved lugs are brass, nickel plated, flattened on top as shown. Made of a single piece of metal. Lead wire goes into tube.
L3110, L3080 "Perfect" Lugs, Each\$0.02
Dozen lots20

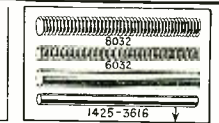

Brass Rods
Sold in 6" lengths only. L8032 Rod 8-32" thread length\$0.08
L6032 Rod, 6-32" thread length\$0.06
L1425 Rod, plain, 1/2" round, length\$1.10
L3616 Rod, plain 3-16" round, length\$0.06

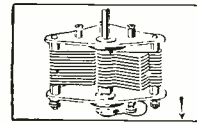

Panel Mounting Grounded Rotor Condensers
Positively no better condenser made. Lowest losses, pigtail connection, binding posts, aluminum plates, rugged construction. Used by 9 big set manufacturers.
L2113 12-plate\$1.50
L2123 23-plate1.90
L2143 43-plate2.85

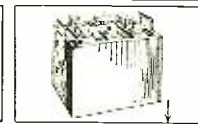

Storage Batteries
Guaranteed for two years. Only NEW material used. Acid proof terminals. Patent vents.
L2400 Two volt, 40 amp. hours\$3.90
L640 Six volt, 40 amp. hours7.25
L666 Six volt, 60 amp. hours9.50
Shipped express collect.

New 1925 "Rasco" Catalog No. 12

CONTAINS 75 VACUUM TUBE HOOK-UPS, 300 ILLUSTRATIONS, 500 ARTICLES, NOW 100 PAGES

All Armstrong Circuits are explained clearly, or values having been left leaving out nothing that could puzzle you.
Just to name a few of the circuits: The V.T. as a detector and one-step amplifier; all Armstrong circuits; one-step radio frequency amplifier and detector; three stage audio frequency amplifier; short wave regenerative circuits; 4-stage radio frequency amplifiers; radio and audio frequency amplifier; inductively coupled amplifier; all Reflex Circuits.

FREE
A POSTAL CARD BRINGS IT

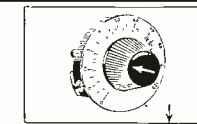

Rheostats and Potentiometers
Come with metal dials and composition knob. Excellent merchandise despite low price.
L4210 6 ohm Rheo.\$2.27
L4211 30 ohm Rheo.36
L4212 200 ohm Potentiometer45

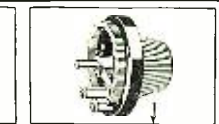

Rheostats and Potentiometers
High heat dielectric base. Come with tapered, knurled knob, 2 1/2" dia. Complete with pointer.
L4310 6 ohm\$3.88
L4311 30 ohm44
L4312 Potentiometer, 200 ohms65

RADIO SPECIALTY COMPANY, 98 Park Place, New York City

Factories: Brooklyn, N. Y. Elkrigde, Md.

Get fullest enjoyment on your outings with OZARKA PORTABLE Radio Everywhere You Go



Weighs only
25 pounds

Here it
is!

Complete \$75

Price includes Four No. 199 Tubes, Built-in Hy-Power Loud Speaker, Four Eveready 22½ "B" Batteries, Three Eveready "A" Dry Cells, One Eveready "C" Battery, Aerial Equipment, ready to unroll—all installed in neat fabrikoid covered case—complete weight 25 lbs.

It's Going to Be
A Great Radio Summer
Keep In Touch!

NEVER before a radio summer like this. All over the country leading stations have boosted their power. It's going to be great this summer. Think of it. No matter where you go—no matter how rough you are dressed—how tired you may be, just hitch up the Aerial of Ozarka Portable to the nearest tree or pole and listen in to the finest entertainment the country can provide.

Many of the most interesting sporting events come in summer. You hate to miss the baseball scores, the fight results, the race winner. Next days papers aren't soon enough. Think of hearing the ball game inning by inning—the fight round by round—the race lap by lap.

The Ozarka Portable will bring you all this—it is built for long distance. Efficiency is not sacrificed to make it portable. No indeed. It's a high grade instrument—built for loud speaker reception. You'll enjoy it for home use when the vacation days are over.

The Ozarka factory representative will gladly bring this remarkable radio instrument in portable form to your home—let you tune it—let you listen to its volume and clarity of tone—let you decide that it's the biggest \$75 value in a complete radio instrument you have ever heard of.

Men Wanted!
for this opportunity
NOW—and others
later

SUMMER radio is here and here to stay. The country is blanketed with high power sending stations. The air will be full of entertainment, sporting news, just the things that everyone on vacation craves.

The Ozarka Portable is the necessary link. It is small, light, easy to carry. It is wonderfully efficient in results.

It represents a wonderful opportunity for you to make some real money and form a connection with the famous Ozarka organization of over 3,100 factory representatives.

Right now you can make hundreds of dollars taking orders for the Ozarka Portable—this Fall you can continue and increase your earning capacity representing the complete Ozarka line sold and serviced only through Ozarka men.

Knowledge of radio is not essential. Men with the right stuff are what we want; men of good reputation and character; who stand well in their community and are looked up to.

If you are ambitious and industrious and looking for an unusual opportunity to apply these qualities for the making of a real success, here it is. Write today and ask for Ozarka Plan No. 100. Be sure to mention the county you live in.

OZARKA, INC., 855 Washington Blvd., Chicago, Illinois



RADIO NEWS

H. GERNSBACK, Editor and Publisher
 SYLVAN HARRIS, Associate Editor

EDITORIAL AND GENERAL OFFICES, 53 PARK PLACE, NEW YORK

Vol. 7

JULY, 1925

No. 1

SUMMER RADIO

By HUGO GERNSBACK

THIS is the fourth summer since radio broadcasting started in this country. When radio first became popular, early in 1922, it was widely predicted, even by radio experts, that summer reception would be so poor that nobody would care to listen in. The summer of 1922 disproved this statement entirely. Radio broadcasting went on during the entire summer, and hundreds of thousands of people listened in to their perfect satisfaction, and did not find the reception much different from reception at other seasons of the year.

To be sure, radio reception is not as good during a hot, sultry summer day, when there is a thunderstorm in the offing, but on the other hand, static, during the summer time, is not a great deal worse than at certain other periods during the year. For instance, in the spring and fall, when heavy rains are in progress, or when the temperature changes suddenly, or when snow is falling, there is much static, which at times is much worse than that on a clear summer day. The impression that static is much worse during the summer is not entirely borne out by the facts. The majority of summer days are entirely free from bad static, or even when it is bad, not only during the summertime, but at any other season of the year, reception is not greatly hampered unless you are trying for DX.

Static, to radio, is the same as street noises to our living-room. If you are listening to local stations, which, as a rule, come in with good power, the static noises are usually not heard at all, and do not make themselves objectionable because the power of the receiver, unless it is a crystal set or a one-tube affair, is sufficient to drown out static noises.

If you are sitting in your living-room and talking with some one, the street noises coming in through the window interfere with your conversation somewhat as static interferes with reception. If you converse in a normal voice, it will be found that the street noises do not interfere very materially and the louder the tone of conversation, the less the interference.

SO far, scientists are not agreed upon what really constitutes static, except that it is known to be an electrical disturbance due to atmospheric conditions. Many queer things happen in connection with static, that are not as yet clear. For instance, suppose you are listening to a station a thousand miles away. The weather at the broadcast station, as well as at your station, is clear. Somewhere between the two stations there is a thunderstorm creating a tremendous amount of static. Nevertheless, in many cases, you are not aware of the fact, when listening in, that such a storm exists. The reason is that the radio waves pass directly through the static field without hampering reception. It also happens that this same condition is true when there is a thunderstorm at or around the broadcast station. It might be thought that under these conditions the reception would be exceedingly bad. This, however, is not the case at all in most instances. As a general rule, it seems that static hampers a receiving station only when atmospheric conditions are bad at the receiving end. Of course, this is only a general rule, because if you are listening in to a broadcast station fifty miles away and there is an atmospheric disturbance blanketing not only the transmitting but the receiving station as well, then static is bad at the receiving end, for obvious reasons.

As for danger from lightning, the writer has pointed out frequently in his past articles that this theory has been exploded many times during our past experience. If you have an indoor or loop aerial, you do not need a lightning arrester, for the possible effect of lightning on these is nil. The writer has also pointed out before that there does not exist an authenticated case wherein lightning ever struck an outdoor aerial and did any real damage, providing the installation was equipped with a lightning arrester. As a matter of fact, rather than being dangerous to the building,

the radio aerial positively becomes a source of protection to the building, exactly the same as a lightning-rod system. If lightning strikes your house and there is no lightning arrester and no aerial, the chances are that some damage may be done to the dwelling. The radio aerial, being a good conductor and grounded through a lightning arrester, offers an opportunity for lightning to pass down to the earth without doing damage. We repeat, therefore, that there is no danger from lightning from this source.

OF course, a radio outfit with an outdoor aerial should not be used during a thunderstorm, for a very simple reason. If the outfit is working, and even a small lightning charge should pass through the aerial, some damage might be done to some of the delicate instruments of the set, such as, for instance, burning out a transformer, which is wound with wire as fine as a hair—or perhaps burning out one or more tubes, although the latter is an exceedingly rare occurrence, the writer never having heard of such a case. So it is best, during a thunderstorm, simply not to use the set, or at least not while you actually see lightning.

In order to prove our contention that the above facts are correct, RADIO NEWS is instituting herewith a \$300 Prize Contest, in order to ascertain this summer whether lightning causes serious damage to buildings equipped with radio.

As a rule, house owners are afraid that an aerial on the roof, if struck by lightning, may set the house afire. This seems to be the only fear in their minds. RADIO NEWS contends that no such thing has ever happened, or can happen, and is willing to pay \$300 for any authentic proof showing that lightning has done such damage.

The rules of the contest are as follows:

1. Any one may compete in this contest.
2. Only radio installations with outdoor aerials and a standard make of lightning arrester are eligible as entries in this contest.
3. The usual ground connection, such as water-pipe, radiator, or any other good and equivalent ground connection employed in standard practice, must be used.
4. A sworn affidavit, sworn to by two responsible individuals who have inspected the damage, must be submitted to RADIO NEWS.
5. Proof must be furnished that such damage was not caused by other means, such as explosions from gas, etc., fire from chimneys, etc.
6. A photograph of the damage caused by lightning, either to the radio set or to the building, must be submitted.
7. A story, of not more than 1,000 words, giving minutely the extent of the damage, time at which lightning struck, and other valuable information, must be submitted.
8. No entries will be considered under this contest where no real damage has been done. By *real damage* we mean that (1) Lightning should have set fire to the house, (2) lightning should have wrecked part of the building, without setting fire to the house, or (3) lightning should have wrecked the radio outfit entirely, damaging it irretrievably, or (4) any of these three combined. The burning out of a transformer, or of one or more tubes in a radio set, would not be considered as real lightning damage, under these provisions, the intent of the contest being to prove that lightning never does actual property damage to any extent.
9. The prize will go to that entrant who, in the opinion of the judges, shows the greatest damage (money value) done by lightning.
10. In the event that more than one individual reports an identical damage in money value, the one who furnishes the best description and the best photographs will be entitled to the prize.
11. There will be only one prize—namely, \$300.
12. This contest closes on October 10th, 1925, when all entries must have been received. RADIO NEWS hereby pledges itself to publish any and all entries, even though they do not win a prize.

\$300.00 in Gold
**RADIO NEWS HERE-
 WITH OFFERS \$300.00
 IN GOLD FOR ACTU-
 AL PROOF THAT
 LIGHTNING EVER
 STRIKES A RADIO
 AERIAL CAUSING
 PROPERTY DAMAGE
 TO THE BUILDING,
 TO A RADIO SET, OR
 BOTH.**
**THIS ANNOUNCE-
 MENT GIVES ALL THE
 DETAILS OF THIS
 PRIZE CONTEST.**

Radio Goes to the North Pole

By JOHN L. REINARTZ

Another chapter in radio may be written this summer when, for the first time, the ultra high frequencies are to be used on an extensive scale.



WHEN the MacMillan Arctic expedition starts for the North Pole on June 15 it will carry the very latest advances in radio equipment, upon which it will depend for communication with the home land.

Never before has an Arctic expedition left home with plans for being in communication with civilization every day. And it is possible this time, only through the recent investigation in the use of ultra-short waves—the newest development in radio—which cover enormous distances with small power.

Not only the communications to the home land will be the function of the radio apparatus carried. Quite the contrary. The

chief uses will be in connection with the flight itself, which will be orienting different parts of the expedition, collecting the very important weather reports and, above all, experimenting. It is hoped that in this experimentation many new points will be discovered which will help to build up the necessary field of technical knowledge for the handling of these new high frequencies. Such information would be of tremendous value in putting them more generally to work.

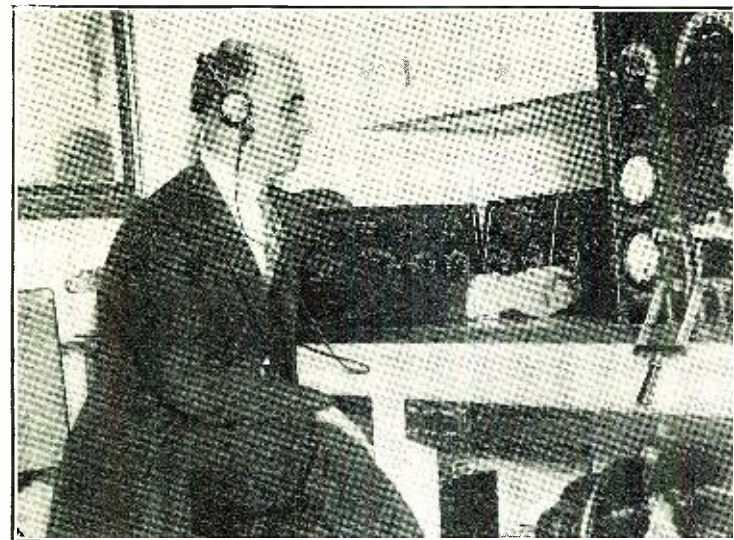

Commander MacMillan, of Polar expedition fame, who is making another cruise this summer in which radio is to play a most important part.

Of extreme importance are the weather reports, for the chief work of the expedition will devolve upon the three amphibian airplanes which will constitute half the expedition.

ROUTE OF THE EXPEDITION

Upon leaving Wiscasset, Maine, where the *Bowdoin*, the expedition's ship, is now resting, the party will sail directly to the edge of the Arctic. It is hoped that they will reach a point about 500 miles from the Pole. Of course, if ice and weather permit, the boat will go closer. In any case, it will take as great a leg of the journey as possible.

From this point the three planes, with their necessary apparatus for repairs and the regular business of flying, together with food, clothing, tents and all necessary impedimenta for establishing a camp, will start a trek still further into the North. Not the least important of the apparatus making this journey to the base which is to be established will be a complete radio receiver and transmitter of the short-wave type.

The present plans are to establish a base for the planes about 250 miles or less from

the Pole. From this point the planes will fly over the Pole and other regions not yet discovered. If all plans are carried out and the expedition is attended by good luck, much of the great Arctic, now practically unknown, will be mapped and surveyed. And in all of this, radio will be the guiding factor. In fact, such a trip would be out of the question without it.

Each of the planes, of course, will be equipped with radio, so that it may communicate with the base or with the mother ship. On one of them there is installed the short-wave apparatus and on the other two the standard army 500-cycle spark transmitter with companion receiver.

DIFFICULTIES WITH C.W. SET

Here is a great obstacle in the path of good radio work. In connection with the C.W.—the tube short-wave transmitter and receiver—the ignition of the engine causes all sorts of trouble.

In preliminary tests it was found almost impossible to keep the set in operation while the engine was actually running. I have made a great many tests with the set and have finally come to the conclusion that the only method by which it is at all possible to operate the apparatus is to instruct the pilot of the plane to fly very high, then when a message is to be received, to shut

WE present herewith the plans of what promises to be one of the most far-reaching experiments ever made in radio. Mr. John L. Reinartz, world-famous radio experimenter, to whom is due most of the credit for the present development in the utilization of the short waves in radio is to accompany the MacMillan Arctic expedition to the North Pole this summer and carry on the work in the ultra-frequencies, in which he has been so successfully engaged during the past year.

The expedition is completely equipped, so far as radio is concerned, and the plans are to utilize the co-operation of the American amateur in order to arrive definitely at an entirely practicable and dependable system for short-wave, low-power radio transmission. It is hoped that sufficient data will be gathered to formulate the laws governing this field.

All who can are asked to listen for the signals of the MacMillan station every day at noon, 6 A. M., 6 P. M. and midnight and to make complete notes covering the conditions, reception, etc. The wavelengths used will be near 10, 20 and 40 meters, with possibly several tests at 5 meters. Complete constructional details for building and operating sets to cover the bands of waves used are appended at the end of Mr. Reinartz's article.

Get in on a real radio investigation!

—Editor.

off the engine and let it idle for half a minute or so, while the message is being copied. Through this method, the plane could remain aloft and still copy from stations on the ground.

Not so much trouble is experienced with the spark installations, but this advantage in their favor turns to a disadvantage when it is discovered that the distance over which it is possible to work this type of set is practically negligible, compared with the tube installation.

This is the receiving hook-up upon which will depend a great deal of the success of the Polar radio experiments. The inductances are changeable, a different size being employed for each of the wave bands used. These bands are 40, 20, and 10 meters.

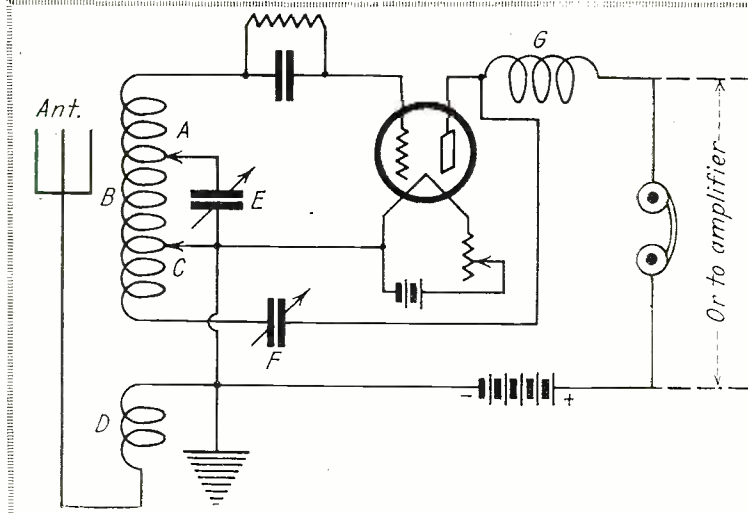

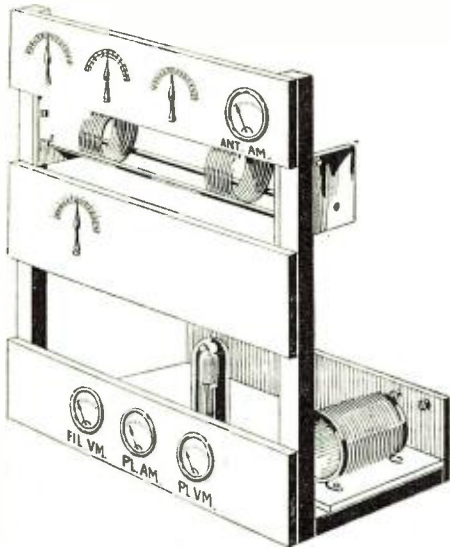

The lay-out used by Mr. Reinartz in constructing his short-wave 500-watt transmitter, which is to furnish contact for the MacMillan expedition.

The tube set being used consists of a 201-A type tube used as a modulator and another one as oscillator. With this combination, using 300 volts on the plate, it was possible to converse from the plane in the air, while flying over Chicago, to South Manchester, Conn., a distance of more than 900 miles. The wave-length used was twenty meters. It is hoped that this one plane installation will serve to cover all emergencies.

At the plane base there will be another of the short-wave installations, which will be in touch with the ship at all times. This will keep the ship party advised as to advances, needs and conditions of supplies, making any chance of misfortune a very distant possibility. The ship will be well provisioned and a line of communication will be easily established between the outpost and the ship. The ship station, if necessary, will forward weather information to the plane base.

From the ship every day at 6 A. M., noon, 6 P. M. and midnight, messages will be transmitted on 40, 20 and possibly 11 meters for pick-up by United States amateurs, the naval experimental station at Anacostia, D. C., and the Great Lakes Naval Station at Chicago and the station of the Zenith Company, also in Chicago, who furnished most of the transmitting apparatus for the various installations.

DISPATCHES FROM THE ARCTIC

Some of these dispatches will contain news for the National Geographic Society and the Associated Press; others will be of a test type. All these tests will be carefully calibrated, particularly with regard to wave-length and time of reception together with intensity of received signals. It is very important that all who receive them make these notations since, at the conclusion of the expedition, an attempt will be made to deduce from this data the laws of transmission at ultra-frequencies. Here, incidentally, is a chance for every radio fan to help make radio history.

In regard to the new transmission on the 10-meter band, reports already in show that signals from such a transmitter, situated near Hartford, Conn., are four times as strong in Europe and on the Pacific coast, as signals of the same power input at 20 meters. This seems strange and brings up a point discussed to some extent in my article published last month in RADIO NEWS: that, at these short waves the distance of audibility is a very narrow band, comparatively speaking, making it practically impossible to hear a station on the ultra-frequencies, except through a well-defined band, beginning

sometimes several hundred or even thousands of miles from the station. This may account for the difference in audibility. An instance of this is the fact that the same station, transmitting on 5 meters with a 50-watt set, is entirely inaudible at noon time any closer than the southern tip of Florida, and even that seems to be too close!

Along this line it might be well to begin getting ourselves accustomed to the thought that within a year all the broadcasters will be working around 100 meters. They have already made some plans for 150 and unless I am wrong they will go down even further—and keep on going down.

HOW TO LISTEN FOR SIGNALS FROM THE ARCTIC EXPEDITION

Back again to the Arctic trip. All those who listen for the signals of the *Bowdoin*, W.N.P. should listen one meter above the band in all cases, i. e., at 37, 44, 23 and 17 meters and then at approximately 10.

Following is a description of the transmitter and receiver which will be used on the trip and which the ordinary amateur may construct for working in these new bands. A few precautions should be added, however. When using sockets for the tubes, the metal barrel should be slit from top to bottom to prevent eddy currents and bad capacity effects in the tube. It is not at all necessary to remove the base in order to make tubes oscillate at these low wave-lengths, but it is necessary to drop the old Hartley circuit, for it will not function at all.

Do not use bakelite end-plate condensers. If at all possible, obtain those with hard-rubber insulation. The bakelite blisters and becomes a fairly good conductor in this field. In building the inductances shown in the sketches, use glass beads, held in place with thread.

REINARTZ SHORT-WAVE TRANSMITTER

A short-wave transmitter may be constructed from standard parts and a suggested arrangement is shown in Fig. 3. The framework should be made of any hard wood which has been boiled in paraffin to drive out all moisture. Bakelite or rubber should not be used. The wiring diagram is shown in Fig. 4. Plate and filament voltages suitable for the particular type of power tube used should be supplied.

Condensers A, C, D and E are transmitting variable condensers capable of withstanding the plate voltage, and are of about 250 mmf. capacity. B is a fixed condenser of 1,000 mmf. suitable for the plate voltage used.

Coils G and H are edgewise-wound helices about six inches in diameter, supported on

three glass rods, as shown in the illustration. Twelve turns on each coil should be used for 40 meters and 5 turns on each for 20 meters.

F is a single-layer choke coil one inch in diameter and four inches long, wound full of No. 24 D.C.C. wire. The grid leak, L, may be about 10,000 ohms.

In operation, condensers A and D are set alike and at a low value of capacity. Condenser E is then varied until maximum antenna current is obtained. Condenser C is used to adjust the plate input and to secure stable operation. Coils G and H are usually placed about twelve inches apart. The key is placed in the circuit as shown at K in the diagram.

The antenna should be a vertical wire about 35 feet high and should be well insulated.

THE REINARTZ SHORT-WAVE RECEIVER

A receiving set which will cover any range desired on the short-wave band is illustrated in Figs. 1 and 2. Fig. 1 shows the wiring diagram in conventional form. Fig. 2 is a suggested panel layout, although the circuit is extremely flexible and may be mounted in almost any way the individual builder desires. It is necessary, however, to keep very short leads in the grid and plate circuits in order to reach as low a wave-length as possible.

The tuning inductances, designated by the coil ABC and coil D in Fig. 1, may be wound on a form about 3½ inches in diameter in either the Lorenz fashion or a single-layer winding on a cardboard tube. Coil D is the antenna coupling coil and should consist of five turns of about No. 16 D.C.C. wire for the 20- and 40-meter bands, and ten turns for the 80-meter band. Coil ABC is really a single coil tapped in two places, as shown in the diagram. Each part, A, B and C, have three turns each for the 20-meter band, six turns each for the 40-meter band, and 12 turns each for the 80-meter band. Three coils are required to cover the entire range from below 20 meters to over 80 meters.

Coil G is a radio frequency choke coil which may consist of a form one inch in diameter and three inches long, wound full of any wire in the neighborhood of No. 30 D.C.C.

Condensers E and F should have about five plates each, and may, if desired, be cut down to 5 plates from a larger condenser.

Either a dry cell or storage battery tube may be employed with 45 volts on the plate.

The antenna may be the usual receiving antenna, or a single vertical wire about 35 feet high.

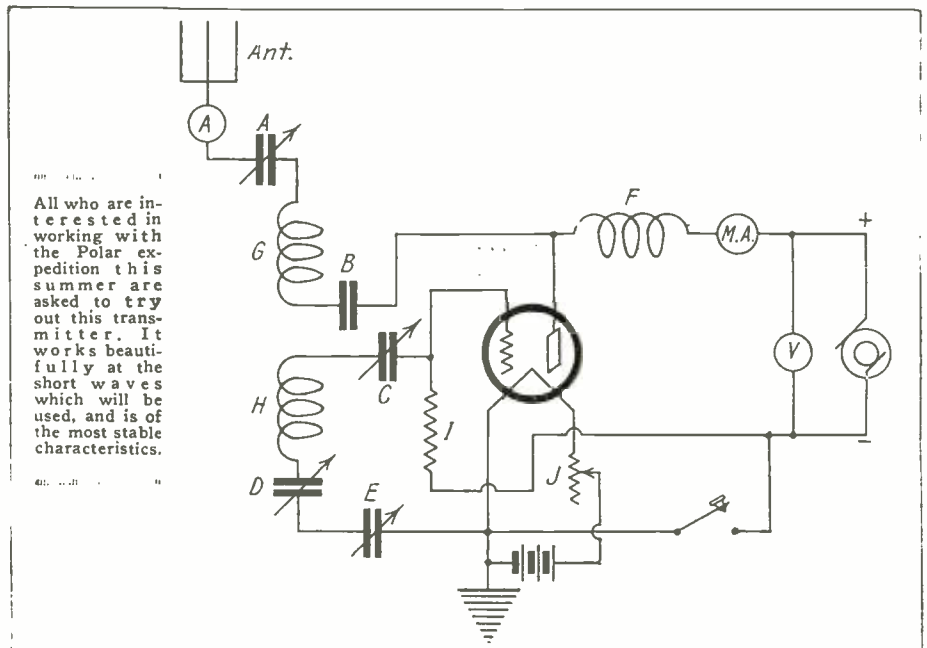

All who are interested in working with the Polar expedition this summer are asked to try out this transmitter. It works beautifully at the short waves which will be used, and is of the most stable characteristics.

Experts Discuss Broadcasting on 150 Meters

Manufacturers, engineers and broadcasters discuss the extending of wave-lengths for broadcasting to 150 meters. Their opinions are for the most part favorable.



Mr. Roy A. Weagent, Chief Engineer of the DeForest Co.

FOLLOWING the publication in the June issue of the article telling of the opening of the broadcast band of wave-lengths to 150 meters, a flood of opinions reached the office of RADIO NEWS regarding the proposed step.

Briefly, as the story detailed, it was ascertained on what this magazine thought to be unquestionable authority, that the Department of Commerce would suggest the step to the radio conference to be held in Washington next September. Of course, this announcement did not mean that such action would positively be taken, though a great many seem to think that such was the case. Quite the contrary. It merely meant that the action was being contemplated as the only step possible to relieve the present congestion in station wave-lengths, and that the final decision in the matter rested entirely with the conference, which is to include representatives of the broadcasters, the manufacturers, the amateurs and the commercial interests.

The announcement was made primarily to crystallize the opinion of the various branches of the interest, so that there will be some sort of concerted action when the conference takes place. Therefore, it is considered of importance to give below a number of the opinions gathered from representative men in the various branches of the industry.

There was a great deal of discussion on the question of whether the opening of the new band was to be a preliminary step toward a complete reallocation of the stations now licensed. This is not the plan at the present time. *The new band is to be opened for the use of new stations who may desire to come on the air, or for the use of those already operating who may wish to move into the higher frequencies.* The only reallocations which will be made to the new band will be upon the request of the stations being moved.

This point was brought out by Mr. Klugh,

secretary of the National Association, in his statement, which will be found at the end of the present article.

This should be stressed often and long, since a great part of the opposition the plan is likely to receive will come from those who think that a complete reallocation is to be made.

The broadcasters approached were, on the whole, pretty well satisfied with things as they are. The one notable exception to this attitude was in the case of Mr. Hugo Gernsback, editor of this magazine and technical adviser of the new station WRNY which, among other things, is taking, voluntarily, the low wave-length of 258.5 meters in the belief that the higher frequencies will, in future, be those sought after for the more advanced stations.

With the manufacturers, in nearly every case, the opinion was mostly favorable to the new idea. Most of them expressed the idea that there would be changes necessitated in the design of apparatus, sets and parts and that even some degree of experimenting would be necessary before complete change-over of sets could be made. However, most of them were conspicuously sanguine as to the ability of the industry to make the change without any great difficulties.

Among the most representative reports from the ranks of the manufacturers was that made by Powell Crosley, Jr., president of the Crosley Manufacturing Co.

Mr. Crosley says:

"Unquestionably, the Department is up against a very serious situation to provide sufficient number of wave channels in the present limited band, and it is going to be necessary to extend the band one way or another. We would prefer to see it extended down to 150 meters than above 600 meters.

"Surely no blame can be attached to the manufacturer who has been selling sets heretofore to cover the band from 200 to 600 meters, if an additional band below 200 meters is opened to broadcast stations. With the present stage of development of the art, undoubtedly there will be other changes from time to time that will make obsolete receivers of some types. However, I do believe that this proposed change is a step in the right direction."

Reports of this sort act as a great shock-absorber to the cries which were raised by some of the smaller companies who see, with the change, a disrupting of the whole field.

And one point must be kept in mind. If the change comes it will be gradual and only after the manufacturers, broadcasters, engineers and listeners have had ample time and opportunity to express their views on the matter.

Another angle of the question was attacked by Mr. Roy Weagent, engineer for the DeForest Company. With him the questions involved are of such a nature as to demand a great deal of study and even some experimentation. He said:

"At present I shouldn't like to absolutely commit myself one way or the other. There are a great many questions involved which need study. Set design, will, of course, have to be changed. And every piece of apparatus in the set may have to be modified—that is a question which can be decided only by experimentation and checking of results. The matter will have to be gone into thoroughly and from every possible point. The case is different with the manufacturer of

only one type of set. With him it is solely a question of designing a new set. With the parts manufacturer that is hardly the state of affairs. We must change, possibly, the design of dozens of pieces of apparatus.

"But the idea of organizing the public opinion on the matter is excellent, since it will give those affected time to find themselves and create a really informed opinion before any definite action is taken."

The attitude sounded in the last paragraph of Mr. Weagent's statement was found to be almost universal. The creation of some sort of public opinion was extremely desirable, according to almost all of those who expressed themselves on the article published last month.

Very enthusiastic and sanguine was the opinion of Mr. D. R. Freed, President of the Freed-Eisman Corporation. He is of the opinion that the industry needs such a change and that the manufacturers will be thoroughly capable of caring for the necessary alterations in market and manufacturing conditions.

"Radio broadcasting belongs to the public," Mr. Freed said. "Consideration of the public interest should be the governing factor in any radical change in the methods of broadcast transmission and reception. If it is contemplated to extend the band now used for broadcasting to 150 meters or even lower, the public should be, and undoubtedly will be, informed of such a change.

"It is a development in broadcasting of the utmost concern to the thousands of listeners, as it may involve the virtual scrapping of many sets. However, for the manufacturer the situation is simpler. He can just as easily turn out sets to receive lower wave-lengths as the present type of sets, most of which do not receive under 200 meters. The manufacturer stands ready to meet the emergency.

"As stated, radio broadcasting has assumed the aspect of a public utility. The broadcast stations and the manufacturers want to

(Continued on page 121)



Mr. John L. Reinartz, well-known amateur, who says that the proposed change will not affect the amateurs.

"The Thermion" Vacuumless Tube

By H. G. SILBERSDORFF, A.M.I.R.E.

In this article is described one of the recent developments in radio "tubes." It is a noteworthy line of investigation.

AS Mr. Silbersdorff says in this article, there have been very few changes in the design and construction of electron tubes except in connection with the details of design. There are the same three elements and the vacuum that were originally presented to us by DeForest in 1907. The arrangement of the elements, the degree of vacuum and method of manufacture have been improved, but essentially there has been no great change.

Mr. Myers is doing pioneer work in getting rid of the vacuum. The vacuum is a costly thing and the conditions of pressure within the tube must be controlled very accurately during manufacture.

The "tube" described here is in process of development, and there yet remains much to be done before it is perfected. Among the very important points that are yet to be divulged are the possibilities of stable operation and constancy of the operating characteristics. This latter point, by the way, is the one that originally suggested the necessity for the very high vacuum now employed.

The tube problem is advancing rapidly. We are making progress in getting rid of the "B" battery, and now it seems that a worthy step has been made toward eliminating the glass and the vacuum.

—Editor.

IT is apparent to anyone who has watched at all the advances made in the art of radio during the past seventeen years that little or no change in the design of the vacuum tube has been made. It would seem that radio engineers consider the losses in other parts of the circuit to be far more important than in the vacuum tube itself, which is supposed to be the heart of the receiver. It is true some steps have been taken to make the tube more efficient, but these steps have been few and far between. All so-called improvements have been made around the same old fundamentals, namely a grid, plate and a filament contained in an evacuated vessel.

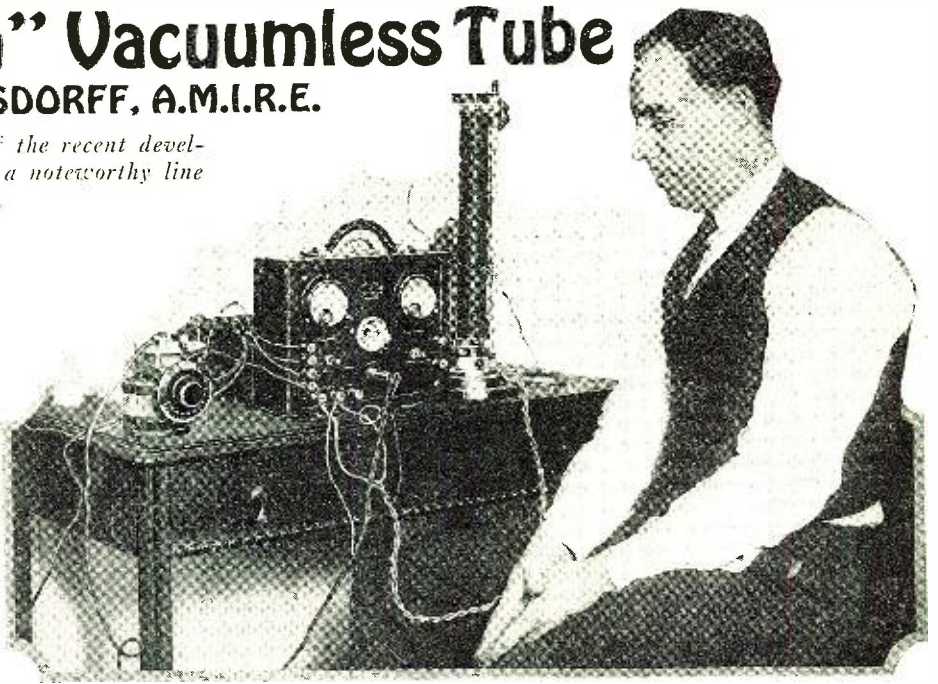

Elman B. Myers, the inventor of the "Thermion tube," and the receiver in which it is incorporated.

These three elements have been "tried out," made up of many different kinds of materials, in various shapes and sizes and with different spacings between the elements with equally different results. There was, however, one thing which could not be altered, so they told us, and that was that the

filament could be overcome, there is still another point which would have to be considered, and that is the factor of oxidization. The grid and plate would soon oxidize and cause an insulating barrier between the plate and filament, making it impossible for electrons to flow between the filament and plate.

OPEN AIR TUBE

Radio has made great strides even during the past few years, probably due to popular broadcasting, and it seems just as soon as someone says a certain thing can't be done, he is interrupted by someone else actually doing it.

This is what happened in the case of the new Thermion tube invented by Elman B. Myers, the well-known tube expert. Not satisfied with the mere building of an "open air" rectifier, he goes one better by using a special filament which he claims is far richer in electronic emission than our present day type. It also has an additional feature of being replaceable by means of two small set screws when it finally does wear out. The open air tube oscillates and like our standard tubes can be used as an audio or radio frequency amplifier, and is comparable in every sense to our present day tubes.

The base and cover are made of Isolantite, a comparatively new insulating material. It was developed during the war under the French Government, and was used extensively by them for the insulation of spark plugs. It is now made in this country under French patents. It is extremely hard; in fact, glass can be scratched with it. It has a higher dielectric constant than mica with a lower phase angle. The cover made of this material is threaded and screws onto the standard four-prong base.

The casing incloses the usual three elements, as the tube operates in the same manner as our regulation tubes, with a filament and plate modulated by the grid. The filament, or emitter rod, measures $\frac{3}{8}$ inch long, with a diameter of .035 inch, this being approximately the thickness of the lead in a pencil. It is formed by an electro-chemical process, the formula of which is a secret of Myers. The filament, too, is so hard that it will scratch glass. It has a fairly high resistance, but a peculiar thing is that when it was inclosed in a tube and pumped, its resistance went down to about four ohms.

Myers claims the filament should last
(Continued on page 86)

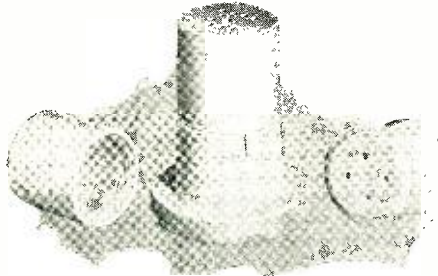

The base and cover of the tube, which are made of isolantite.

three elements must be operated within a vacuum. First, because the filament would burn out if we tried to operate it in open air, and second the resistance between the filament and plate would be so high, that it would be impossible to get even a comparatively small current to pass this barrier. Assuming that the aforementioned bar-

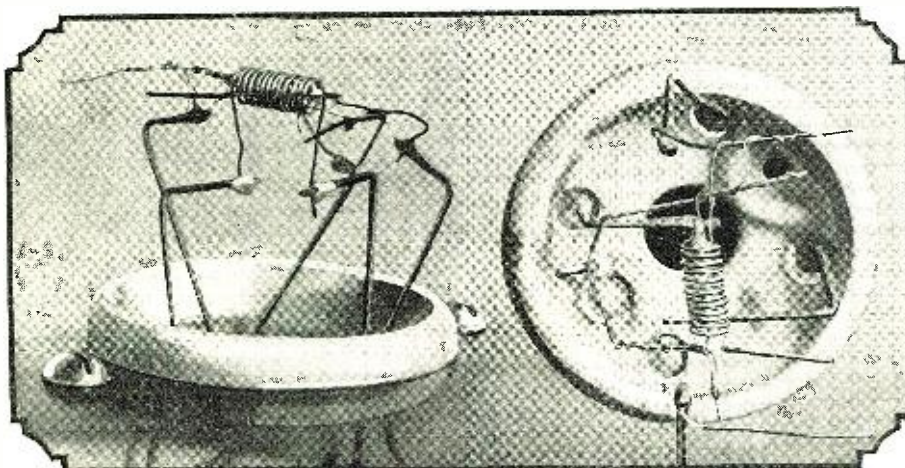

Two views of the "Thermion tube," showing the elements described in the accompanying article.

The Inventions of Reginald A. Fessenden



ORVILLE WRIGHT



HENRY FORD



THOMAS EDISON

Three world-famed individual inventors who, the Research Council says in the "New York Times" for March 1, are of a type no longer important.

PART VII

THE Great Ages pass quickly; that they were passing has never been believed at the time; nor has the cause, which has always been over-organization brought about by well-meaning but too narrowly educated men, been appreciated. The first thing every student of community affairs should study is real history; not the history of names and dates and battles, and not for the purpose of extrapolating curves based on empirical data, but for analysis of the causes which have led to the results shown by the curves and of the modifications of the curves produced by variations of the causes. Such study makes it clear that the only vital growth of a civilization is that which comes from its own internal kinetic pressure, and that the application of statical and mechanical directional forces result only in wreckage. The essential thing is freedom to expand in all directions, because there are fundamental reasons, which will be given later, why no body of men can ever determine the true direction for growth.

As an illustration, the "great age" of Plato, Aristotle, Demosthenes, Aeschines, Menander, Diogenes and Epicurus was succeeded in the very next generation by Ptolemy's great organization of literature. The production of great works was to be carried out by hundreds of writers, co-operating. Every effort was made to discourage the independent writer and to make literature a monopoly. The great Library of the Museum at Alexandria had finally more than half a million volumes. The export of papyrus was forbidden by law, and when the king of Pergamus, in an attempt to break the monopoly, gathered together a library of books written on a newly invented substitute for papyrus, *i. e.*, parchment, his library was seized and carried to Alexandria. Through generation after generation the foundation was the hobby of the kings of Egypt. It was richly endowed and the poets, scholars and scientists who lived in what Timon called "the coop" were free from all material worries. And the result? In the five hundred years of its existence (B. C. 300 to A. D. 270) not one single original work of any importance was turned out by any member of the foundation, except the "Argonau-

tica" of Apollonius of Rhodes, and that, on its reading before the members, was laughed out of the hall so that its author "flushing with mortification" as his Greek biographer records, severed his connection with the foundation and fled to Rhodes.

EFFORT OF RESEARCH COUNCIL TO ELIMINATE THE EDISON-WRIGHT-FORD TYPE OF INVENTOR

This is of course not the first of the inventive ages. Invention has appeared so far only intermittently, as Kipling's torch, "re-kindling thus, and thus." There was a time, extending over more than 5,000 years, during which science was in the hands of an international council, called the Cabiri, apparently exactly similar to our present Research Council, during which there was absolutely no development. Will their antiquated and discredited policy, now revived by our own Research Council, of eliminating the individual inventor, be successful? These plans, which were formerly kept secret (and for the most part are now) were recently divulged by a number of the members of the Research Council in the *New York Times* for March 1, 1925, p. 4. The article opens by saying that the day of Edison, Wright and Ford is past; that:

"Henry Ford worked on his automobile almost unaided in a little room at the back of his house. The Wright Brothers designed the first airplane in a bicycle shop. Edison experimented in a baggage car.

"But the old-fashioned inventor has ceased to be the all-important factor in invention that once he was. The work of experimenting and inventing has been made the work of vast organizations, of immense and adequate equipment, and of virtually unlimited financial backing."

This is of course the old story. The "Do away with the individual author and give everyone access to a great library and a pension and we will have innumerable great literary works" of Ptolemy. The "Do away with the individual painter, and teach all children to paint, and we will have innumerable masterpieces" of another set of enthusiasts. The "Do away with the individual owner of property and we will all have all the property we can wish" of yet another set.

One must sympathize with these objectives. We do want more inventions, because every invention, *e. g.*, that of steam which manumitted the galley slave, lifts a burden and broadens comfort so that now the luxuries of Babylonian kings and Roman noblemen have become the necessities of our day laborers. We do want more great works, in literature and art, and we do want every one to have all the property he can use efficiently. But should there not be some demonstration, even on a small scale, that the objectives can be reached by the means proposed before throwing away the present system, which has given us what we have?

What the United States, and the world, owe to the individual inventor we all know. Take away the cotton gin, the steamboat, the telegraph, the electric light, the automobile, electric power, the typewriter, the sewing machine, all the other work of the individual inventor, and there is substantially nothing left. On the other hand, it is admitted by all who have studied the subject that, to quote Russell, *Nature*, November 1, 1924: "It is of course true, as others have pointed out, that epoch-making discoveries have not yet come direct from teamwork or organized research." Is it wise then to eliminate the individual inventor until teamwork has produced at least one such important invention?

Of course, the failure of the Research Council, after the expenditure of so many millions, has had to be covered up by propaganda. The following is a list of inventions which the Research Council has prominently published as its work:

Inductor compass for airplanes.

Ultra-violet light signaling.

Under-water wireless.

Audion oscillator.

Sonic depth-finder.

Wireless compass.

Liberty motor.

Submarine detector.

Airplane wood-drier.

Wireless transmission of pictures.

Ultra-audible sound signaling.

but each of which was to my personal knowledge communicated to the Research Council officials by the inventors, *e. g.*, the

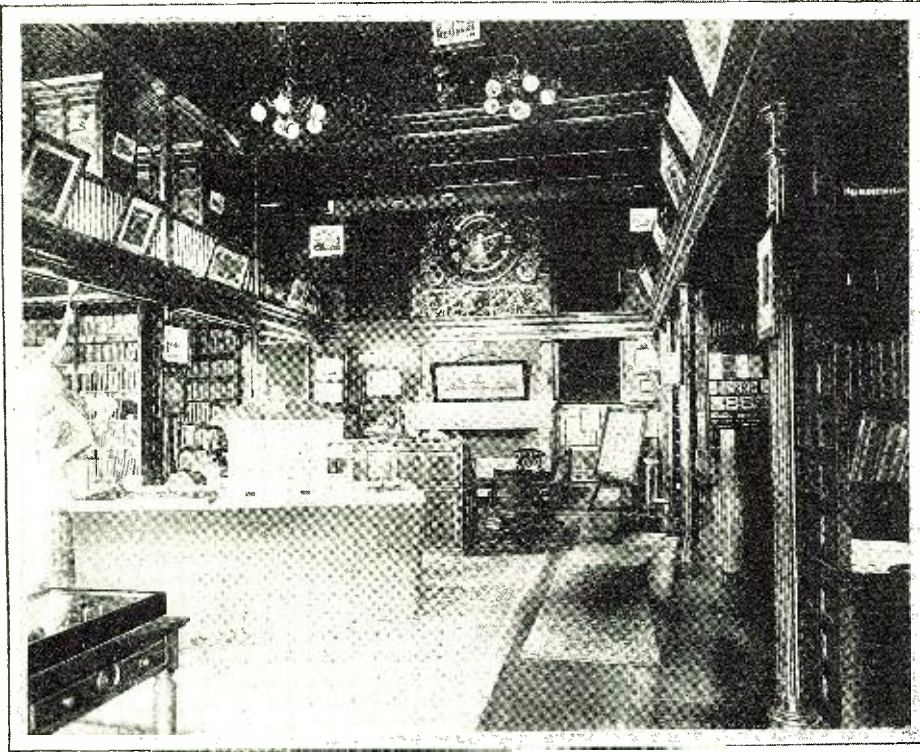

The library of the famous laboratories of Thomas A. Edison at West Orange, N. J. The great inventor keeps a full set of bound volumes of his laboratory notes in this library.

Inductor compass by Pickard.
 Ultra-violet light signaling by Louis Bell.
 Under-water wireless by Rogers.
 Audion oscillator by DeForest.
 Liberty motor by an engineer of the Packard Co., etc., etc.

in each case after practical and successful tests, many of which I witnessed myself, *e. g.*, I operated Louis Bell's ultra-violet signaling apparatus perfectly over a distance of five miles. And in each case the Research Council, after witnessing the tests and privately constructing duplicates of the inventor's apparatus, arranged that the U. S. Departments should procure the apparatus from members of the Research Cabiri, without paying the inventor anything, and propagandized the U. S., at government expense, with statements that these inventions were due to the Council. The list given in the *New York Times* of March 1, 1925, is of similar nature, *e. g.*, the first invention claimed by the Research Council or Cabiri officials, the "invention that makes it possible to photograph sound on a motion picture film" is of course DeForest's. The next, the microphotographic talking book, in regard to which the article states, the Research Council official was asked, "Are you working on such a device now?" he smiled. "Not as a whole. I just happened to think of it," was really a matter of recollection, for it was shown to the official in the inventor's laboratory in 1920, and his company was asked if they could furnish the quartz discs referred to in the following account taken from a book published in 1923. (Deluged Civilization, p. 134.)

"The microphotographic book—made from two quartz discs, one-sixteenth inch thick and an inch and a quarter in diameter. . . . When it is not desired to read visually the book may be read audibly, by a parallel phonographic record." A photograph of the apparatus used for making the phonographic records appeared in one of the radio journals the previous year. The next, "we have done away with the small diaphragm" was shown to the same official by the inventor in 1919 and written acknowledgment of receipt of a full description of the theory is in the inventor's possession. The next, the single crystal wire, was developed in Germany before the war and applied to tungsten

filaments. The next, the nitrogen lamp, is old, and will be found described in the back files of the Amer. Inst. of Elect. Engineers.

WILL THE EFFORT TO ELIMINATE THE EDISONS, WRIGHTS AND FORDS BE SUCCESSFUL?

Personally I do not think so, because I have hopes that the seriousness of the situation will be realized before it is too late; it is one of the main objects of these articles to bring about that realization, and to suggest means for combating the schemes for the elimination of the individual inventor.

But it must be admitted that the Cabiri have had a certain amount of success so far. The writer, having other and many resources, has not been much affected; he has had to give up his researches on cancer, which were very promising and had effected a permanent cure (no return after three years) in a case pronounced one for operation by the head of perhaps the most authoritative cancer hospital staff in the U. S.; and has had to obtain the fine grain photographic plates for some of his researches from abroad and secretly, to prevent the

supply from being cut off. But many have felt the effects very seriously. The suicides of McDowell and Webster are especially regrettable. McDowell's because his firm, the Brashear Optical Co. had always freely communicated all its optical secrets to Hale (who I understand is or was head of the Research Council) and other members of the Council. Consequently, he could not compete with Hale's corporation, the Mt. Whitney Observatory, which was heavily endowed from the Carnegie funds, and could make lenses at less than cost. (I see also, by last week's *Nature*, that the big English optical works of Sir Howard Grubb has also had to go out of business, and in another paper that the Mt. Whitney associates have obtained the contract for the great Switzerland telescope.) Knowing Carnegie as I did and the affection which he bore to Brashear and McDowell, and the fact that he intended his foundation fundamentally for the use and assistance of just such men, I feel that Carnegie must have turned in his grave when McDowell died.

Of Webster, whose great work is known all over the world, it is said that he had been in a nervous and unsettled state before his suicide. But he was very proud of Clarke University, and how many men would have preserved their full equanimity on receiving word that the Research Council had decided that the laboratory which had been hallowed by the work of Michelson and Wadsworth and his own work on sound was to be turned over into a school for geography, and that he must look, at his age, for a new position? And minor cases are innumerable; as the pressure is being felt I receive requests for help almost every day.

POWER AT THE COMMAND OF THE RESEARCH COUNCIL

Let us first make a survey of the tremendous grasp which the Research Cabiri has on the wealth of the United States and the despotism which it exercises.

1. The total funds at its disposal or in the shape of foundations from Carnegie, Rockefeller, Eastman and others, and from other sources, is in excess of \$10,000,000,000.

2. This is, however, but a fraction of the total amount of capital which it controls. In the first place it is international. In the second place, all the industries in the United States (and in the principal foreign countries) are divided into groups. These the Research Cabiri rules with a rod of iron through secret international reports. As the description of this system should be made authoritatively, I will quote from the authorized statement, made by the head of one of the U. S. Government Bureaus and printed

(Continued on page 115)

Exterior of the main building of the Edison laboratories at West Orange, N. J. Large as his laboratories are, Edison has yet succeeded in retaining individualistic inventive characteristics in his organization.



New Uses for the Vacuum Tube

By DR. C. B. BAZZONI

In this, the second of Prof. Bazzoni's articles, he opens up two very interesting fields, both made possible only by our knowledge of radio.

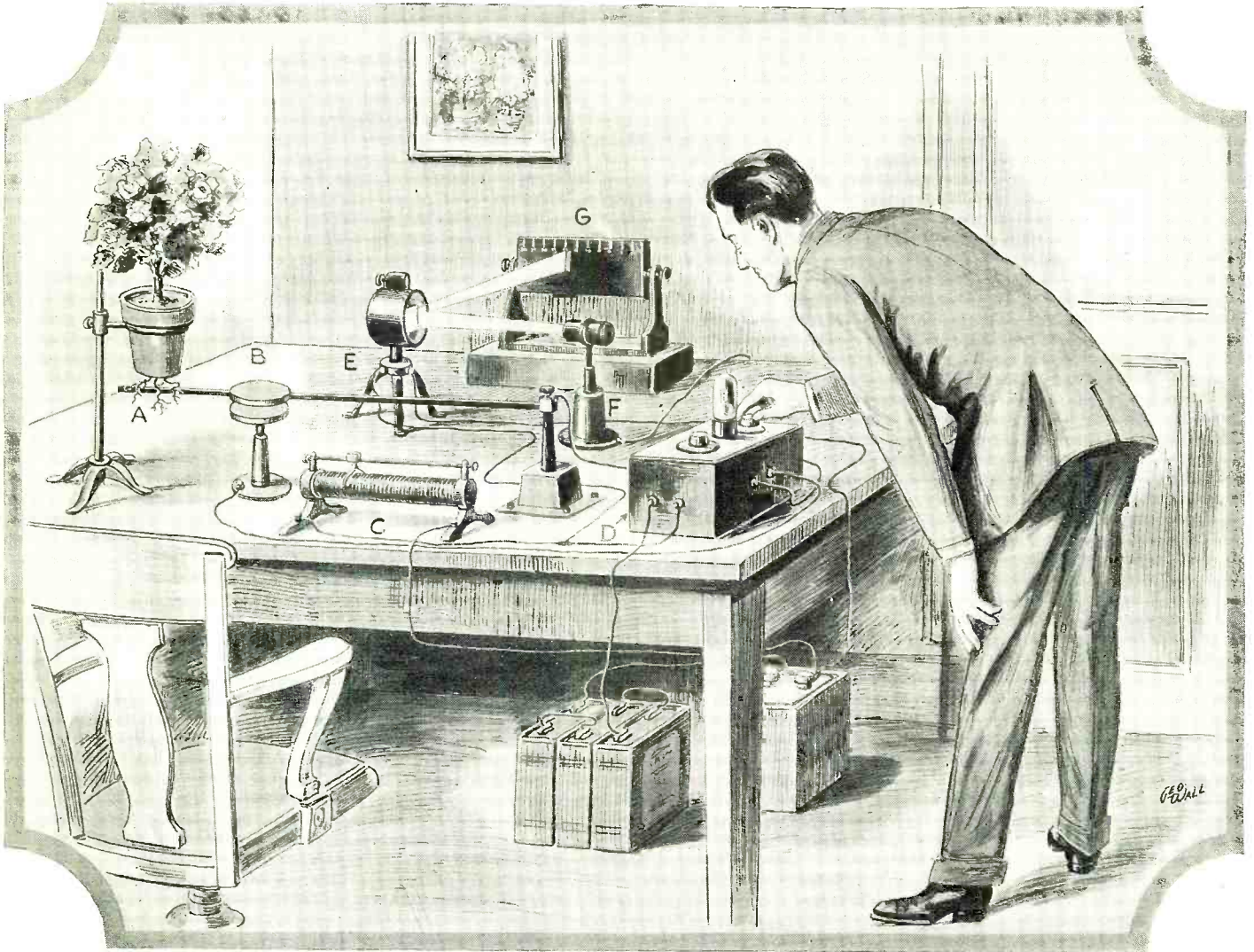

Above is a graphic illustration of the method employed for measuring the growth of plants. A is the plant root pressing on rod connected to small condenser, B. C is shunt resistance, D an oscillator, E, galvanometer, F, source of light and G, scale.

IN the last issue of RADIO NEWS I described several circuits belonging to the heterodyne ultra-micrometer class. It will be recalled that such devices can be used to measure extremely small changes in the capacity or inductance of attached condensers or coils, being capable, for example, of detecting movements of condenser plates through one one-hundred-millionth of an inch. The measurements are made by matching the heterodyne beat note produced by two radio frequency circuits against a steady audio frequency note developed by a tuning fork or some other means. The notes are brought repeatedly to the same relative value by adjusting for the same number of beats per second between the heterodyne note and the standard scale. It can be readily understood that, in practice, this is an ear-fatiguing and, after a little time, confusing job. The ear tires rapidly, especially when dealing with the pure, penetrating tones produced by such circuits, and readily confuses small changes in loudness with changes in pitch. Consequently, an extended series of measurements made with the heterodyne ultra-micrometer is certain to show inaccurate irregularities due to ear fatigue and resulting bad tone judgment by the operator.

*Professor of Experimental Physics at Pennsylvania University.

PROFESSOR BAZZONI in this article describes how the radio experimenter can put his tube to entirely new uses. The vacuum tube is such a marvelously sensitive instrument that almost unbelievably small variations can be measured and charted. In this article he points out how the vacuum tube can be used to measure the rate of growth of plants during a fraction of a minute and how the gravitational attraction between two small bodies can be measured. With such instruments it is possible to measure one-twenty millionth of an inch accurately, and to weigh one-ten millionth of an ounce.

—EDITOR.

Naturally, it would be thought desirable to devise a new circuit which would retain the advantages of the old in sensitiveness, and avoid its disadvantages by substituting a direct reading arrangement of some kind for the uncertain setting by ear. I shall describe just such a circuit in this article.

In the course of development of our knowledge of three-electrode tubes during the past fifteen years, a large number of different circuits have been found suitable for the efficient production of oscillating currents. Many of these circuits are known by name to the radio amateur as, for example, the Hartley circuit, the Meissner circuit, the "tuned plate" circuits and the "tuned grid" circuits, all of which have their important applications in radio. In each case, the grid of the tube is connected with an inductance coil L_g , which is coupled directly or by mutual inductance M with a coil in the plate circuit L_p . These coils are directly or indirectly parts of an oscillation loop containing a condenser C . This loop has a natural frequency of electron surge given by the formula; frequency in kilocycles

$$= \frac{159.3}{\sqrt{LC}} \quad (\text{with } L \text{ in microhenries and } C \text{ in microfarads}).$$

Any little disturbance of the circuit as, for instance, the closing of the filament switch, will start a surge in this loop. This surge will develop a corresponding potential variation on the grid, which will react on the plate current, causing a progressive strengthening of the original surges in that

circuit so that powerful oscillations are very rapidly built up and continued. The frequency of these surges is determined by the total inductance and capacity in the oscillation loop. The ordinary amplifier tubes of radio circuits will operate in circuits set up just like those of Fig. 1, the oscillations being readily rendered apparent by a hot-wire or thermal meter inserted at A.

Since the negative potential at which the grid must be held is different in different makes of tubes, better results can sometimes be obtained by a modification such as is shown for the Hartley circuit in Fig. 2A, where C_b is a large capacity, say 0.5 to 1.0 microfarad, and R_g is a resistance of from 5,000 to 10,000 ohms. The current flowing through R_g during those parts of the oscillation cycle when the grid is positive to the filament produces a drop of potential in R_g which keeps the grid at a negative level. The same effect can be secured by inserting a grid battery of from four to eight volts in place of R_g . In the tuned plate and Hartley circuits it is sometimes also advantageous to separate the direct plate current from the oscillating current, both of which, in these circuits, are superposed in the same wires. This can be done, as shown in Fig.

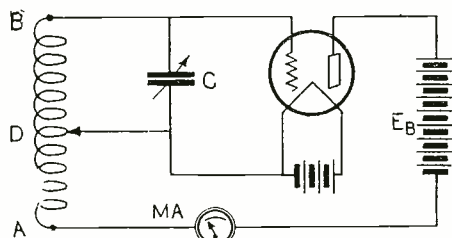

FIG. 3

An oscillator hook-up with a milliammeter in the plate circuit.

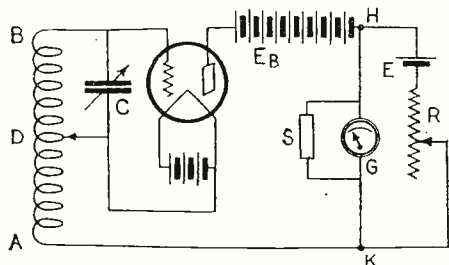

FIG. 5

The oscillator hook-up with the zero shunt across the plate circuit to make the necessary fine measurements.

2B, where C_h is a choke coil with a high frequency impedance of perhaps 50,000 ohms but with a low ohmic resistance. Such choke coils can easily be made by winding annunciator wire on an iron bar. These coils offer an almost impassable barrier to high frequency current but let direct current through readily. In general amateur use, however, these little "improvements" are unnecessary, the simple circuits shown in Fig. 1 being entirely practical.

THE ULTRA-MICROMETER

The ultra-micrometer which I am about to describe can be built up with any one of the above-mentioned circuits as a basis. Let us suppose that we have set up a tuned grid circuit like the one shown in Fig. 1 and that we have introduced an ordinary D.C. milliammeter into the plate circuit at X. This milliammeter will record the direct current component of the plate current only. If the sliding contact connected to the negative end of the filament is moved along the inductance L_g - L_p , thus altering L_g , L_p , and the mutual coupling M oscillations, as shown by the reading of the thermal meter A will be maintained in the loop L_g - C as long as the slider is between certain limiting positions,

say a and b in the figure. When these oscillations start, the apparent resistance of the tube is reduced and the direct plate current increases.

This increase is shown by the reading of the milliammeter at X. If now we set the filament slide at some definite point, as c, and alter the value of the capacity C, thus changing the natural frequency of the oscillation loop, two capacity settings will generally be found, one an upper limit and the other a lower limit, at which the oscillations cease abruptly. If the milliammeter is watched while the condenser knob is being turned, the milliammeter reading will be seen to vary with the condenser setting, going from a low value at the lower capacity limit through a maximum and down to a low value again at the upper capacity limit. This variation is so regular over part of its range and so sensitive to small changes in the capacity of the condenser that the changes in the milliammeter readings can be used to detect and measure changes in the capacity. Since these capacity changes are in proportion to small displacements of the condenser plates the milliammeter readings can be used to measure very small movements of the plates. In other words, the circuit can thus be used as an ultra-micrometer.

HOW TO BUILD IT

The principle of operation of this type of ultra-micrometer having been brought out in the preceding paragraph, we shall now turn to a description of a practical working circuit of this sort, such as is shown in Fig. 3. The tube may be a 201A, a 301A or any similar tube. C is a variable 43-plate condenser with the usual capacity range up to 1,200 micromicrofarads. This condenser ought to be provided with a vernier adjustment. The coil AB is of bare wire, No. 18 or No. 20 will do, wound on a wooden frame which may be six inches square and two feet long. There should be between A and B about 150 turns of wire, properly spaced to prevent "shorts." The connection D may be made where desired by means of a movable clip.

In the diagram we have a milliammeter indicated at M.A. If the experimenter rigs up this circuit, setting D, say, eight inches from B, and slowly turns the dial of C he will observe a movement of the pointer of the milliammeter as predicted above, but this movement will be difficult to read accurately on the scale. This is because, while the

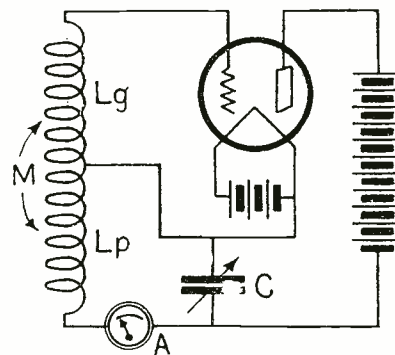

The colpitts oscillator which, with certain modifications, can be used to measure the growth of plants.

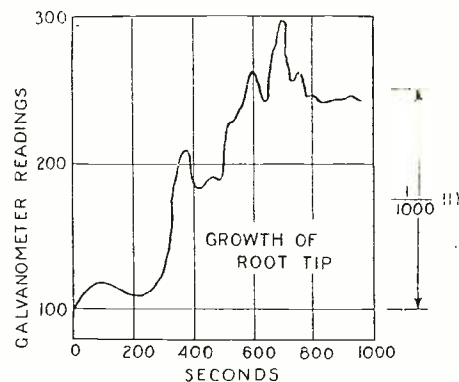
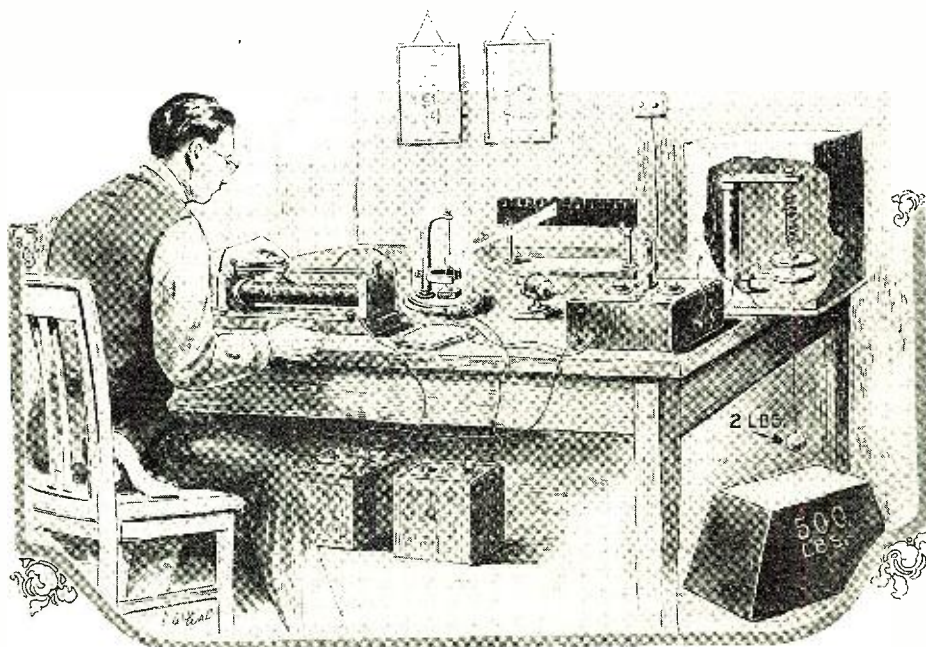

Fig. 8 shows the growth of a typical plant, which is about one-thousandth of an inch in 18 minutes.

normal value of the plate current is 4 or 5 milliamperes, the variation in it caused by moving the condenser knob one division is perhaps only 5 or 10 microamperes (millionths of an ampere). It would seem, at first glance, impossible to introduce any current-measuring instrument in place of the milliammeter which would be sensitive enough to show the changes, microamperes in value, produced by rotating the condenser slightly and yet would not be completely "thrown off the scale" by the milliamperes of ordinary plate current flowing through it. A clever method for overcoming this difficulty was, however, devised by J. J. Dowling of the University of Dublin, Ireland, in 1921. This device was called by Dowling a "zero shunt." It was the application of the zero



This drawing shows the set-up of apparatus used in measuring the gravitational attraction between the large mass and the small one hanging from the condenser plate.

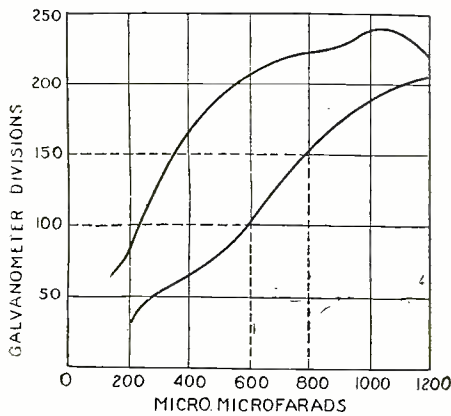

Fig. 6. The top curve, B, and the bottom curve, A, show the relation of capacity change to current change.

shunt to the circuit shown in Fig. 4 which made this form of ultra-micrometer practical.

The operation of the zero shunt is easily understood. Let us suppose that we have a D'Arsonval galvanometer of the laboratory pattern. This instrument is like an ordinary Weston direct current meter, consisting of a coil of wire mounted between the poles of a permanent magnet, but, in the galvanometer, the coil through which passes the current to be measured is suspended from a very thin wire instead of being supported on jewelled bearings. This construction makes the instrument much less portable than a Weston instrument and, at the same time, much more sensitive. Such galvanometers of excellent design, capable of showing current changes of one one-hundredth of a microampere, can be purchased for about twenty dollars. A small concave mirror is mounted on the front of the coil, from which a beam of light is reflected to a scale and the deflections of the coil are thus noted.

Our galvanometer is to be connected at G in the circuit arrangement of Fig. 4. S is a shunt resistance which can be varied to bypass more or less of the current which would otherwise flow through G. This shunt is very useful to protect the galvanometer from injury during adjustments of the circuits. At R is an adjustable high resistance which should have a resistance at least ten times that of the galvanometer. At E a small battery of one or two or more cells is introduced as shown. Now current will flow through G as long as there is any difference of potential between the points H and K. The plate current flowing through R produces a drop of potential in R, the so-called RI drop, which, in volts, is equal to the number of ohms in R multiplied by the current in amperes flowing through it. By sliding the contact along R, we can adjust this RI drop until it exactly equals the potential developed by the little battery E. When this condition is reached there will be no difference of potential between H and K and the galvanometer will read zero. This reading holds, however, only for the one value of the plate current, I, for which $R \times I$ equals E. If the plate current alters from this value, the extra current will flow between H and K. If R has a resistance high compared with that of the galvanometer, practically all of the extra current will flow through the galvanometer.

USING THE ZERO SHUNT

Let us now introduce this galvanometer with its zero shunt into the circuit of Fig. 3 giving it the arrangement of Fig. 5. Next adjust R until the galvanometer does not deflect when the circuit is not oscillating—when, for instance, the condenser is set at zero—and then swing the condenser knob around. The galvanometer will show large deflections corresponding to the alterations in plate current produced by the capacity changes. If we set the condenser knob successively at 200, 400, 600, 800, 1,000 and

1,200 micromicrofarads and note the galvanometer reading at each setting, we get a series of results which we can plot in the form of a curve.

In Fig. 6 we show a pair of curves taken with the device of Fig. 5. Curve A was taken when the clip D was set five inches from B, curve B when the clip was six inches from B. The galvanometer was shunted at S so as to give fifty divisions deflection on the scale for each milliampere flowing through it. It will be seen from the curve that, in case A, the galvanometer read 100 for a condenser setting of 600 micromicrofarads and 150 for a setting of 800 micromicrofarads. Thus we have a change in the galvanometer reading of one division, corresponding to a change in capacity of one-fourth of a micromicrofarad. If the shunt S were entirely removed from the galvanometer so that one microampere flowing through it would deflect it 100 divisions, we would have one scale division corresponding to a capacity change of two one-thousandths of a micromicrofarad. It would, however, be entirely impossible to move the condenser plates by hand so as to give such extremely minute changes in capacity.

Suppose now that we introduce the special condenser of two steel plates two inches in diameter described in my article on the heterodyne ultra-micrometer into the circuit in place of the variable sector air condenser. The plates of this special condenser, which is pictured in Fig. 7, can be warped apart through very small distances by sliding a

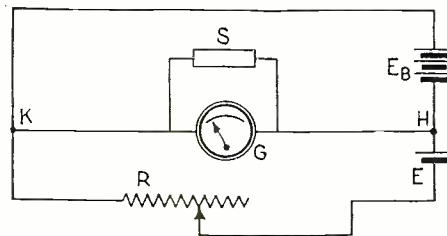

FIG. 4

Above is the zero shunt galvanometer method of measuring minute current changes.

weight along the extended arm A. With this device we would find that spreading the plates one twenty-thousandth of an inch would cause the plate current to vary by ten microamperes. If the galvanometer were used at its full sensitivity, 100 divisions per microampere, a deflection of one scale division would therefore correspond to a movement apart of the plates through one twenty-millionth of an inch—a distance equivalent to ten times the diameter of an atom of hydrogen!

It is evident from the facts presented above that the zero shunt ultra-micrometer can be used in any of the numerous applications described for the heterodyne ultra-micrometer. In addition, since it is less sensitive to electrical disturbances, it has also been applied in various new connections, some of which we will now examine.

MEASURING "GROWTH PULSES"

In 1919 a distinguished scientist, Bose, noted that plant growth is rhythmic, the growth of roots and other parts exhibiting certain "growth pulses" separated in time by three or four minutes. Dowling demonstrated these pulses very definitely. He built a special condenser with a lower fixed plate and an upper movable plate supported by a light flat spring. The movable plate was provided with a light wooden arm against the end of which the growing root tip was allowed to press. The spring was so weak that the pressure necessarily exerted by the root was extremely small. This condenser was introduced into a zero shunt ultra-micrometer circuit and a series of galvanometer readings taken at ten-second intervals. The results are shown in the curve of Fig. 8, which is constructed from the figures given by Dowling in his original report. The growth pulses are here plainly shown at intervals of about 200 seconds. The total movement of the root tip in the eighteen minutes covered by the curve was about one-thousandth of an inch.

With this device Dowling was also able to demonstrate the attraction due to gravitation between bodies of ordinary size. We all know that there is a force of attraction, the so-called "gravitational force," which, acting between every pair of bodies, tends to draw them together. It is this force which draws a stone to the earth and which holds the planets in their orbits. It is evident from the general law, that this force of attraction must exist between small bodies as well as between large ones. It must exist, for instance, between the chairs in a room and between the books on a table. The force is so small that it cannot be demonstrated with bodies of ordinary size.

The arrangement of Fig. 9, when placed in a micrometer circuit, will, nevertheless, render the action of this gravitational attraction easily apparent. A condenser P is made with a lower fixed plate and with an upper movable plate supported from a stretched spring. A weight of about two pounds is attached by a silk thread to the upper plate, the thread passing through a hole drilled in the lower plate. If a second weight of about 100 pounds is placed beneath the first weight, even at a distance of a foot, the force of attraction between the two weights will draw the upper condenser plate down far enough to deflect the galvanometer of the ultra-micrometer several hundred divisions. The force which must theoretically be acting between the two weights can easily be shown by calculation to be about one ten-millionth of an ounce. The ultra-micrometer is thus seen to be a very delicate weighing instrument. The experiment described is naturally difficult to carry out, on account of the disturbances of the upper weight, so delicately supported on its sensitive spring, from tremors and shocks.

By making the suspended weight heavy and altering the spring support the tendency of the condenser plate to respond to tremors

(Continued on page 107)

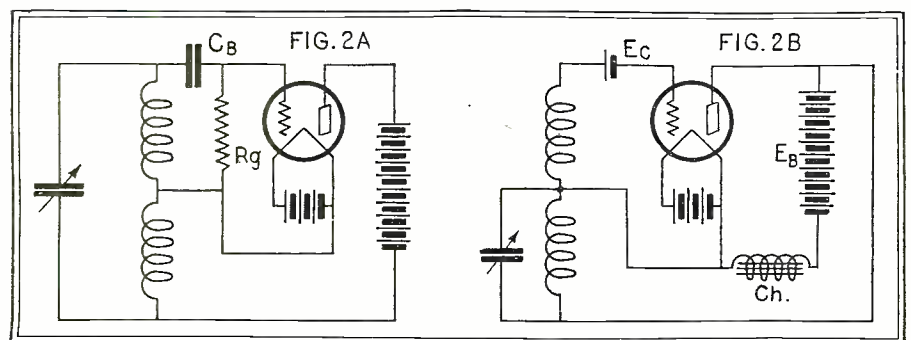

Oscillator hook-ups with refinements to which the zero shunt may be attached for fine measurements.

New 110-Volt Vacuum Tube

By G. C. B. ROWE

Another step forward in radio—a tube that operates from the 110-volt house-lighting circuit.



At last the bugbear of storage batteries and their attendant nuisances is laid low. No longer will we have to wonder whether the "A" battery is charged to the hilt when company is expected, so that the old set will perk pretty. The only necessity is 110 volts A.C.

A type of tube operating from the house current has been experimented with for several years. Research laboratory workers have seen what possibilities an electron tube possessed which had its filament heated by 110 volts and what innumerable advantages it had over the tube that depended on a storage or dry battery for its filament heating. Alternating current was chosen to operate the tube, because its use is almost univer-

sally today. Only in certain sections of large cities is direct current found, so that more than the majority of radio fans will be able to use this tube.

operation of this tube is the same as those with which all radio listeners are familiar, the electrons flowing to the plate and their stream being controlled by the grid.

This tube is said to have a greater electronic emission than the average tube, because of the greater area of the cathode or heated element. Naturally when there is a condition such as that, the general efficiency of the tube is increased, because for a given input of energy there is a larger output of electrons. Also the cost of operation of the tubes is less than that of the average tube. The figure given for a receiver of five tubes is two-tenths of a cent per hour.

FILAMENT CIRCUIT

The filament is heated by the current from the 110-volt line, stepped down by means of a small transformer to 4 volts. The transformer has a tapped secondary in order that the voltage may be varied when more than three tubes are used. When four or five tubes are used, 5 volts must be applied to the filament and when six or more tubes are in the circuit, then 6 volts are used. Each tube takes 1 ampere. There are no rheostats needed with these tubes to control the filament voltage and this in itself is a saving, not only in initial cost, but also in that there are as many less controls to bother with when tuning in the receiver.

The filament terminals are connected in parallel in a multi-tube receiver, this being easily accomplished by placing two parallel wires level with the insulator plugs on the

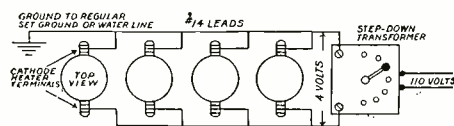

How the tubes are connected through the step-down transformer to the 110-volt circuit.

CONSTRUCTION

The internal construction of the tube differs from the usual type in that the filament is enclosed in a porcelain tube which, in turn, is in a metal sleeve. This filament construction is supported from the top of the tube instead of the bottom, as has heretofore been the practice. On the outside of the top of the glass is an insulating plug having two terminals for the filament connections. The metal sleeve which is around the porcelain tube acts as the cathode of the tube and is connected to one of the usual filament prongs of the tube.

The operation of the tube is far from complicated. The filament heats the porcelain sleeve by radiation and thus transfers the heat energy to the metal surrounding it. This metal, the composition of which is manufactured by a secret process, emits electrons at a comparatively low temperature. The functioning of the remainder of the

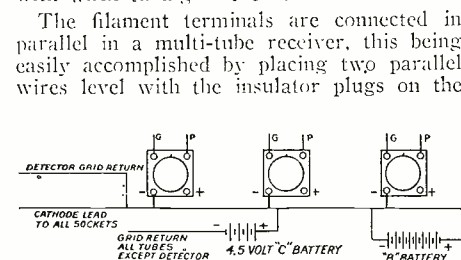

Diagrams of connections of the "B" and "C" batteries with the 110-volt tube.

top of the tubes and making connections to them. It is recommended that the 110-volt transformer be placed more than a foot away from the set, but in a five-tube radio frequency receiver the writer witnessed a test where the transformer was passed near every part of the set. Only when the transformer was placed within an inch or so of the audio frequency transformers was the 60-cycle hum even noticeable.

GRID AND PLATE CIRCUITS

To use these tubes in a receiver there are only a few slight changes necessary in the wiring. These changes consist of discarding the present filament circuit and connecting the negative leads of the filaments together, which lead is then used as the grid return and is connected internally to the cathode of the tube. The use of a "C" battery aids the receiver in that it may be connected to the grids of all the tubes except the detector and in this way reduce "B" battery consumption to a minimum. A diagram indicating how the "C" battery is connected in the circuit is shown in Fig. 2.

The grid and plate leads are connected as for any ordinary tube. Plate voltages up to 150 volts may be used on the plates of the amplifier tubes and the plate voltage of the detector is far from being critical; the average is about the same as that employed for the storage battery type of tube.

It is said that with these new 110-volt tubes there is a naturalness of signals in

respect to tone and volume. Also there is a marked freedom from distortion. The tubes have a long life, on account of the fact that the cathode operates at very low temperature. Because of the heavier construction of the filament element and its sur-

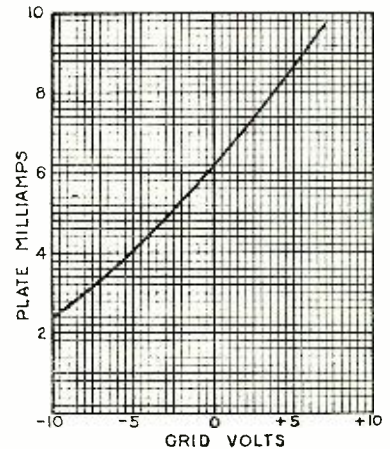

Characteristic curve of the 110-volt vacuum tube.

rounding cathode plate, there is a marked absence of microphonic noises.

These advantages may not seem important to the average broadcast listener, but they should be considered, for they really are a step in the right direction. Nothing is more annoying than to jar a receiver accidentally in the middle of a good song and have the answering "bong" sound for several seconds.

Few fans fully realize that an electron tube has more or less definite life and that this life can be prolonged or shortened according to the manner in which the tube is treated. However, in the 110-volt tube the filaments are operating at the same temperature and this temperature is the one that is best for the life and operation of the tube.

There is no bother from run-down storage batteries, no filament rheostats to adjust, and the danger of burning out the filaments is eliminated, because the leads from the transformer are entirely a separate circuit from the plate connections. In short, this new tube is something that radio fans have been eagerly awaiting.

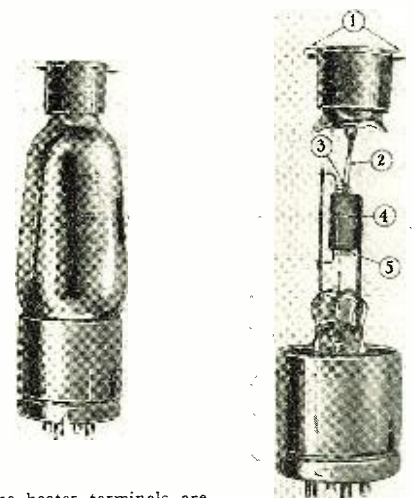
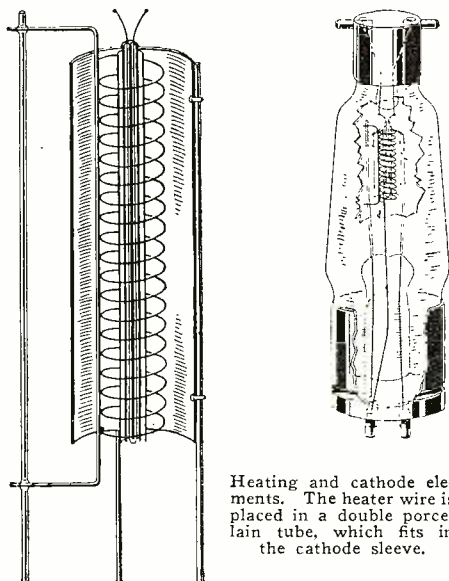

The heater terminals are marked 1, 2 is the porcelain tube, 3 the cathode, 4 the plate and 5 the grid.



The Life and Work of Lee DeForest



PART X

ALTHOUGH the Atlantic fleet of the United States Navy was well toward the middle of the Pacific Ocean, and in spite of the fact that the fleet was fully equipped with the new DeForest radio telephone, the press and public were still talking about the *Thelma* incident.

Shortly before the installation of the equipment on the fleet—and one of the chief reasons for DeForest's getting the commission to install the apparatus—he and his helpers had installed the first radio telephone on a private yacht then anchored at Put-In Bay. The *Thelma* was a trim little craft of some forty feet, with good engines and fully seaworthy. Her master was anxious to attend the forthcoming yacht races to be held on the bay and wished to take some part in them. Consequently, DeForest found easy installation for his new phone.

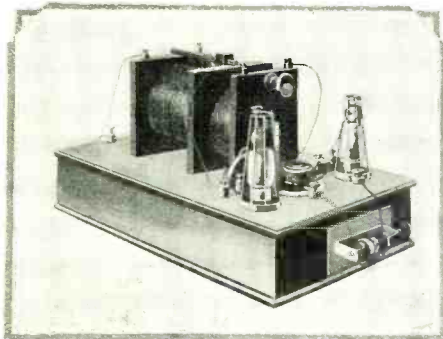

One of DeForest's commercial receivers is shown in the above photograph.

The necessary parts were shipped from the New York office of the Radio Telephone Company, and DeForest, with a couple of assistants, rushed to the scene to make the installation. The fore and aft masts were heightened and the antenna installed. It consisted of a whole flock of wires running the length of the little craft. The antenna was really a first class affair, containing some fourteen wires in the flat top portion. In the cabin the apparatus was installed. The generator which furnished the power for the arc transmitter was placed alongside the

boat's engine and the phone panel—if it may be called such—was placed adjacent to the wheel.

FIRST RADIO SPORT TALK

All was set for the races. On the morning when the craft were all gathered to see the start, the *Thelma's* screw took a few preliminary turns and the operator at the phone made his first call to the shore station. To his great delight, when he threw the set over into the receiving position, the answer came through clearly and distinctly. Above the growl of the engine and the shouts of the captain and passengers, the set worked perfectly, mile after mile, as they steamed on toward the finish buoys. And all the time the two men at their radio telephones were in perfect communication.

The captain, after a little maneuvering, brought the *Thelma* to a good position in front of the finish line. There she waited for the boats to make their race. In a few minutes the leader hove in sight around the point in the bay. The man at the phone relayed the information to those on land. There was much frantic talk as the operator tried to get a full description of the race to the shore, together with a second-by-second report of the advance of the boats.

When they neared the finish line, the operator gave the numbers on the mainsail to the land—then the report of the finish gun. The judges were stationed just off the point where the *Thelma* was riding at anchor. The sound of the gun could plainly be heard, even in the cabin where the phone was situated. The sound of the explosion, of course, was picked up by the microphone and was sent to the land along with the operator's speech. The finish line was some miles from the shore. The sound of the gun did not reach those on the shore for some seconds on account of the slowness of travel. The sound of the gun as picked up by the microphone, however, was heard by the operator several seconds before the actual sound had traveled the intervening distance. The thing was almost uncanny. It was such an obvious illustration of the speed of travel of radio waves! Those who were standing in the immediate vicinity of the receiving station on land heard the operator shout "finish!" fully five seconds before they heard the report of the judge's gun.

After the completion of the reporting of

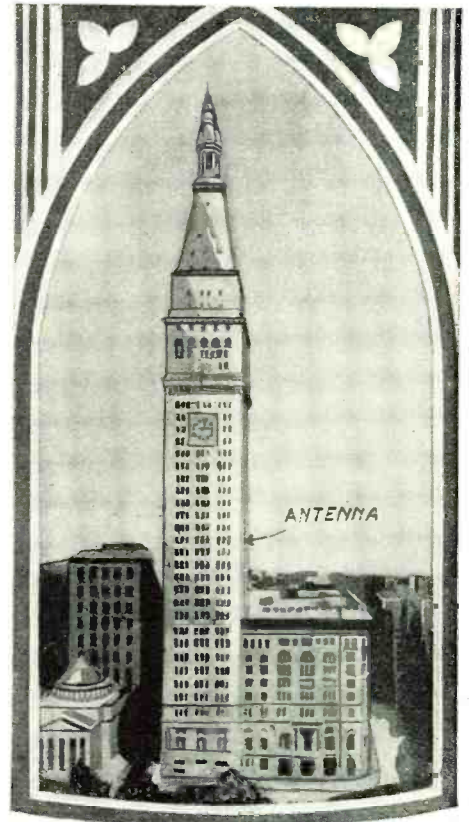

The Metropolitan Tower at Madison Square in New York, where DeForest carried on much of his early radiophone work.

the races, the equipment was taken off the boat and from the land station and shipped back to New York. DeForest and his assistants caught the train and returned to the laboratory in the Parker Building.

U. S. SHIPS INSTALL RADIO

Then there was the business of installing the equipment on the fleet and the attendant difficulties. For about three months everyone in the organization was busy as possible. DeForest was working night and day, both supervising the construction of apparatus for sale, already on contract, and in continuing his researches along various phases of modulation and perfection of the arc which was used as the generator of the continuous waves.

Then for a little time there was ample financial aid for the company and the men working for it. Most of them had come into DeForest's employment on no promise of wages. They had great faith in their principal and in his ability to bring the growing young art into something worth while. They seemed to know that they were making history. One of them came to him, offered his services and insisted on being taken into the staff on the strength of the experience he had had in the line. DeForest told him that there was no money available for more men. Nevertheless, each morning the man would show up, find someone who needed a little help and proceed without further ado to lend a hand.

This kept up for some time and DeForest finally acknowledged defeat. He put the man on the payroll without any stipulated salary. Some weeks he got seventy-five cents, others he got seventy-five dollars.

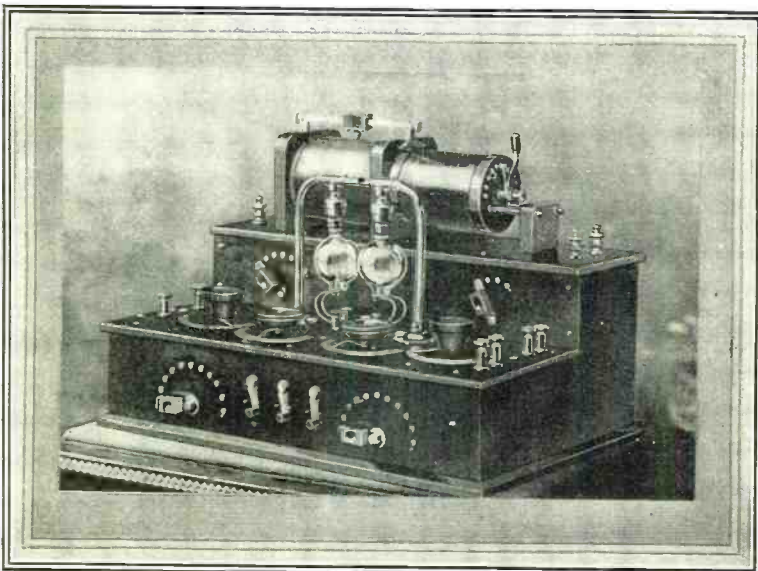

A receiver of the time of the present chapter. Note the old-time Audions and the cabinet construction.

Most of the men in the employ of the company fared likewise. But they all worked with a will and gave all their resources, mental and physical, to the work in hand. They were a hardy crew. Their chief joy was in work and lots of it, and all the time they were confident of the man whom they called "boss" and of the practicability of the thing he was attempting to do.

In February of 1908, DeForest embarked for France and Paris. There were a couple of companies there who were anxious to be licensed under the DeForest patents, and who sought to be recognized as the official French agents for the Radio Telephone Company. Some arrangements had been made for DeForest to carry out a number of tests before the Department of Posts and Telegraphs and for the benefit of the companies concerned.

VACUUM TUBE DEMONSTRATED

Accordingly, DeForest had shipped a few of his radio telephones in the boat with him. Upon arrival, after a few negotiations, he was allowed to use the Eiffel tower for his experiments. At the first deck of the tower, 110 feet above the level of the Seine, he installed the first radiophone on French soil and incidentally made the first demonstration with the little vacuum tube which was afterward to play such an important rôle in the great war which was to follow in less than seven years.

Antennae were hung from the sides of the Tower and the generators were stationed in the base. Tests were made of a gradually widening radius from the Tower. As the men with the receiver moved further and further from the famous Tower, the signals became a bit weaker and weaker until a little beyond twenty-eight miles they faded almost entirely, being audible only under the best of conditions.

It must be borne in mind that this work was done with the shorter aerial, reaching only 110 feet into the air and practically shielded on one side by the steel framework of the Tower. But the range of a little better than twenty-five miles as dependable under all conditions was thoroughly established. Later, one evening, the authorities came to DeForest and told him that he would be allowed to use the main antenna which ran almost to the top of the Tower for experiments. A couple of days of hurried preparations, allowing for the necessary changes in wave-length of the transmitter and the selection of listening stations followed, and the night of the big test arrived. All evening DeForest and his assistants stayed at the transmitter, feeding



The DeForest radiophone station with microphone on the front of the panel.

records to the talking machine which was modulating the carrier current. Early in the morning, near dawn, they returned to their hotel to await results. A couple of days later the first post brought a letter with the Lyons post-mark on its face. It was sandwiched in amongst the remainder of the morning's mail and so did not receive immediate attention. When he finally did open it, however, and had glanced half-way through its pages, he was overjoyed. It told, in perfect French, of the reception of almost the complete program by an engineer listening in at Lyons, five hundred miles away.

ITALIAN WARSHIPS INSTALL RADIO

Hardly had the negotiations with the newly appointed agents been completed when DeForest received a telegram from the Italian Government, asking for a demonstration of his new device. Of course, he gathered up his belongings, lock, stock and barrel and started as fast as the St. Gottard Express would carry him for Italy. At Rome he received an exceptional reception from the officers in charge and at once was given craft and facilities upon which to make his demonstration. Being comparatively fresh

from his attack of the same problems with which he was now confronted in connection with the equipment of Admiral Evans' fleet, matters were more or less simple. Little time was consumed in showing the naval man the efficiency and usefulness of the scheme at hand.

As a matter of fact, they had almost decided to purchase and install several of the sets before DeForest appeared on the scene. His presence and enthusiasm helped them to a quick decision, however. They placed the order and DeForest relayed it on to the New York office. The apparatus was shipped by express in the next outgoing steamer.

As soon as it arrived, DeForest and his assistants set about installing it aboard the Italian destroyers and battleships. There was not quite the hustle necessary on this job that there had been with the installation aboard the United States craft some months before. Toward the latter part of May, 1908, the work was completed and the radio men aboard the ships thoroughly broken into the habits of operating the set. DeForest then turned to other shores.

ENGLISH INVESTIGATE RADIO

He rushed back to New York and the affairs of the company, spending just two months there before he again departed for the continent and England. Following the installations on the Italian ships, the British



The first opera star to broadcast, Mme. Mazzarini. She appeared with Caruso.

Admiralty cocked an inquisitive eye at the efforts of this young Yankee. DeForest saw in their curiosity germs of a large order and better financial condition for the new Radio Telephone Company. So he gathered up three or four of his sets and loaded them into one of the ocean greyhounds and started to conquer the mistress of the seas with his little box of wires and vacuum tubes. He was still employing the arc as a generator of undamped waves, but he had already begun to study the characteristics of the newly discovered quenched spark gap. The chief trouble with the arc still remained, in spite of all he could do. It was unsteady and needed constant watching, besides necessitating a separate generator to furnish its supply of current.

All the way across he spent most of his time in the cabin, pouring over German and French text-books dealing with the characteristics of this new device which promised to be so efficient as a generator of radio waves.

At London, however, he became all business and set himself thoroughly to the task in hand, that of convincing the lords of the British Admiralty that his new radio phone was the one great improvement they needed in their fleet. He pointed with pride to the behavior of the installations aboard Admiral Evans' fleet while it was steaming through

(Continued on page 102)

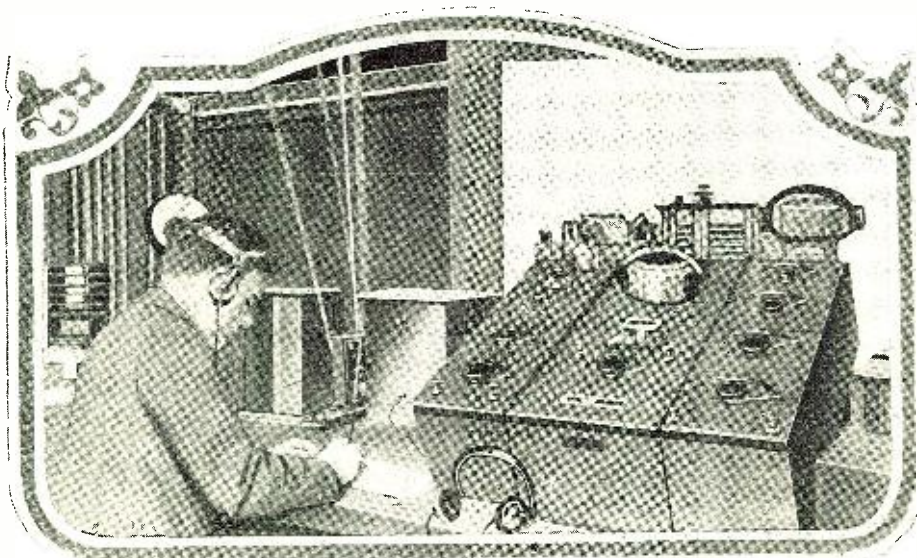

The commercial receiver of fifteen years ago was a formidable affair, as may be seen from the above picture.

What Is Low-Loss?

By SYLVAN HARRIS

WE have low-loss this and low-loss that—low-loss everything, in fact, except—brains.

If there ever was anything that received an over-abundance of emphasis, the low-loss idea certainly is it! And the saddest part of it all is that, as is most usual, those who do the most talking know the least about it. As a result, those who are the learners have become filled with many misconceptions of the low-loss idea. The greatest effect, and perhaps the most serious, is the effect this has had on the pocketbook of the radio fan.

There are low-loss coils, low-loss condensers, low-loss tube sockets, low-loss insulators, low-loss transformers, low-loss everything. The writer saw recently an advertisement dealing with low-loss antenna supports! After a while we shall be wearing low-loss collar buttons or low-loss suspenders. We shall have low-loss nuts and bolts and low-loss wood screws.

The whole thing is ridiculous. Not the idea of low-loss, but the way in which it is being overdone. It has given rise to mis-statements in advertising, not necessarily intentional, but due to the ignorance of the advertisers. These have been taken up by the readers of the advertisements who have repeated them from one to another, as sheep follow sheep. Likewise, many manufacturers have copied the designs of others, simply because they saw that the low-loss propaganda was selling the product of the other manufacturer.

LOW-LOSS IDEA GOOD

The idea of low-loss is a very good one. No sane person will ever dispute that fact. But there is nothing new about it. Power engineers have known the desirability of reducing losses for years and years. There was never a motor or steam engine developed that did not involve the most serious consideration of efficiency. But the power engineer did not go insane over it as the radio people have. The thing has become almost a mania in radio circles; at least, in the design, production and advertising of equipment for broadcast reception and amateur usage.

The average radio fan has been beguiled into believing his set will not work well if he has the least bit of insulating material in its make-up, or if he has any more metal in the set than is required to form the plates of the condensers or the magnets of the telephone receivers. He is ready to sacrifice all that is good in mechanical construction—strength, rigidity and accuracy, etc.—if he can only get low-loss.

Furthermore, he has laid the blame for a

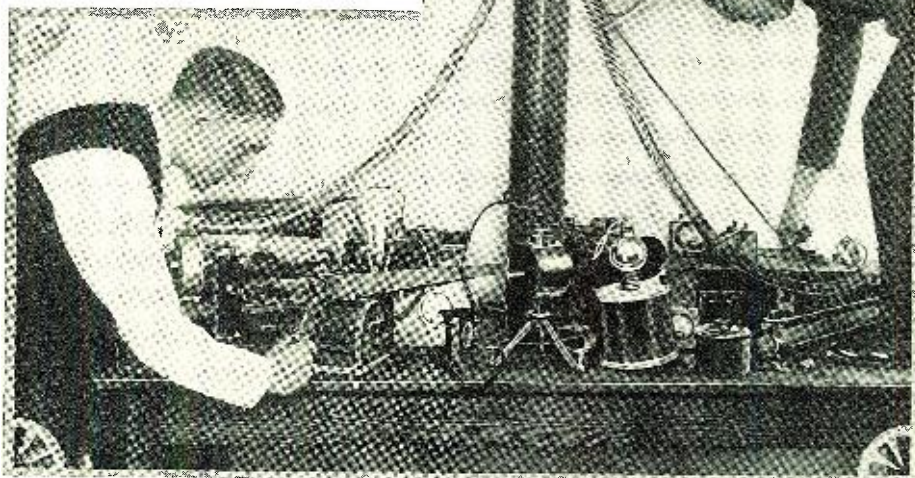

"Experts" looking for losses.

considerable amount of the losses in his set where it does not rightfully belong. Take, for instance, that poor, innocent offender, the insulating material, whereon his coils are wound, whereon his wire is insulated, or whereon his condenser plates are mounted.

OTHER LOSSES OVERLOOKED

He has forgotten, however, that coils wound of No. 25 wire, even if wound entirely on "air," will have considerably more resistance (losses) than coils of ordinary bell wire, with its tons of insulation and wax, even when wound on such miserable stuff as solid tubing.

He has forgotten also that when such ridiculous methods of winding coils as the spider-web method are employed, that the increase in the skin effect, due to the multiplicity of layers, may raise the coil losses 500 per cent., whereas he has saved but a few per cent. by reducing the coil capacity.

He has forgotten, furthermore, that when he has reduced the losses in his condenser by replacing the end-plate of insulating material with one of metal, that he has merely substituted one cause of loss for another. Many condenser "experts" have spoken volubly of the "field distribution" in a condenser, and some few have tried to trace it experimentally, but it will be found that the greatest radio engineers of the world decline to make definite statements about it. They know little or nothing about it and are generally willing to admit their ignorance.

He has forgotten, once more, that although he feels that he must use low-loss tube sockets, no one has ever succeeded in measuring the losses in the sockets.

He has probably wondered why someone has not by this time brought out a "low-

loss" rheostat—well, that's carrying the thing too far. I forgot that the main value of a rheostat lies in the losses it has!

Anyhow, when the radio fan has learned that losses in multi-layer coils are far in excess of those in single-layer coils on account of the skin effect; when he has learned that losses in metal end-plates increase with the frequency, whereas the losses in dielectric materials decrease; when he has learned that the coil (distributed) capacity in almost all coils is a very small quantity compared with the skin effect; when he has learned that the losses in the end-plates of the condensers are as nothing compared with the losses in the very condensers themselves; when he has learned that No. 18 wire has lower resistance than No. 24; when he has learned that the resistance of the wire itself is exceedingly great compared with the insulation losses; when he has learned that no one knows the field distribution in a condenser at radio frequencies and is, hence, not entitled to talk volubly about it; when he has learned that there are very few who can measure losses at radio frequencies accurately—in fine, when he has learned to assign the proper importance to things and not to exaggerate grossly and without cause—only then shall he begin to learn the truth about "low-loss," and know by what means he should build his set to work most efficiently.

Low-loss has no criterion to be judged by; we merely want the losses to be as little as possible. But there is a practical way of looking at it. We cannot reduce the losses to zero. But there is one thing we can do: we can certainly get a great deal more out of our sets than we are now getting. So, rather than worry ourselves to death about "low-loss," let us learn more about the apparatus we have now. It is pretty darned efficient as it is!

There have been volumes and volumes written on the subject of low-loss by a multitude of would-be scientists. The writer must confess that he has joined their ranks, as the reader will see for himself if he will look back into the issues of RADIO NEWS from January to May. But the difference in the writing lies in the validity of the statements made. Most writers, as has been said before, follow each other as sheep follow the leader; the present writer has, in every case, conducted his own research, whether it be theoretical or experimental.

As a good illustration of how they follow the leader, take, for example, the time-worn

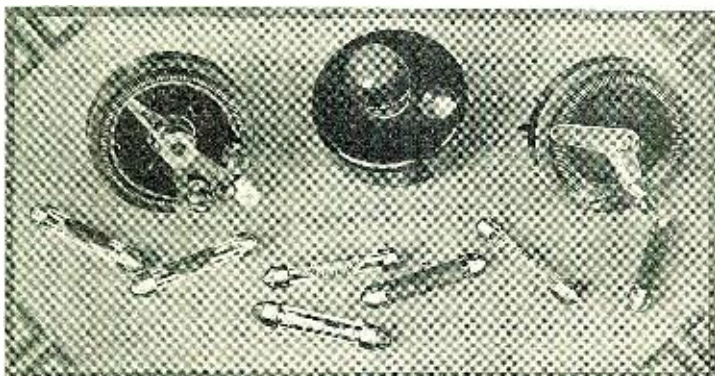

Here are shown instruments installed in every radio set for the express purpose of causing losses.

The Experimenter

has come back! If you are one of the one hundred thousand readers of the old ELECTRICAL EXPERIMENTER, you will no doubt be glad to hear that the EXPERIMENTER has come back BIGGER AND BETTER THAN EVER.

Experimental Radio

Nothing but experiments, written by the foremost radio authorities, also a monthly editorial by H. Gernsback. A fine roto-gravure section to brighten up the magazine. But best of all for you radio readers, is the big radio section of over twelve pages of some fifty radio experimental articles—and mind you, NOTHING BUT EXPERIMENTS.

LIST OF INTERESTING ARTICLES TO APPEAR IN THE JULY ISSUE OF THE EXPERIMENTER

Circuit Analysis.

By Leon L. Adelman, Assoc. I. R. E.

Short-Wave Amateur Receiver.

By Alfred R. Marey, Assoc. I. R. E.

An Excellent Broadcast Receiver.

By Joseph H. Kraus.

The Pianor, An Electric Piano.

Interesting Experiments in Organic Chemistry. By E. W. Blank.

Home-Made Oscillating Rectifier.

By Siegfried Langsdorff.

Experiments with Tesla Resonator.

By Kenneth M. Swezey.

Iron-Clad Lifting Magnet.

By William J. Edmonds.

custom of building coils with a ratio of diameter to length of 2.46. Radio hack-writers generally claim that this is the ratio that must be maintained to build coils having the lowest possible resistance. They base their claims on statements made in Circular 74 of the Bureau of Standards on page 290. But the trouble is that they do not read far enough or with sufficient care, for if they did, they would learn that this applies only

to the resistance to direct currents. In fact, the circular says:

"Naturally, other considerations may modify the design appreciably. These other considerations include the distributed capacity of the coil and the variation of resistance with frequency." (This variation with frequency is the skin effect—Ed.)

As another example, take the old practice of assuming that the resistance of a condenser varies inversely with the frequency. Circular 74 states: "The variation of the power factor and the equivalent resistance with frequency is a complicated matter, the laws of which are not accurately known."

So we might go on with one illustration after another, but our efforts would be fruitless. It seems that the radio hack-writer does not learn easily. The ideas must be pounded into him time and again, in order for him to assimilate even a few grains of information every once in a while. It is the radio hack-writer who has done most of the harm in giving the radio public these misconceptions. He makes positive assertions about matters upon which reputed scientists fear to commit themselves, not because they are incompetent to discuss the subjects, but because they know that many of their statements will be misinterpreted.

The subject of radio is a dangerous one to tackle superficially; it will be well for the reader to peruse once again the article entitled "Specialize," by Pyle, in the May issue of RADIO NEWS. This is a very good article. The main point that it brings out is that it is better to know much about one particular subject than to have a smattering of many subjects.

Radio is too big for anyone to know everything about it, and the subject of losses or resistance in radio circuits requires a very comprehensive knowledge of electrical principles. There are many who try to belittle the technical man who saves time by working out his problems on paper before he

tackles a problem experimentally. It is only the technical man who can understand how ignorant these others are. For the novice will easily show in a few hours how one particular condenser will give better results in ear-phones than another, while the man who really knows will spend months and years on the problem.

Ignorance is a delightful thing. The poor, innocent condenser (or coil) will be subjected to all the tortures of the inquisition before the novice gets done with it. He will not know, when he makes his comparisons, that he is making at the same time other changes in the circuits which generally pass unnoticed.

Even this might not make conditions so serious if it were *only* the novice who is making these mistakes; but there have been many so-called "radio engineers" who have made these same errors. (By the way, I don't happen to know, at the present writing, of any college that awards this degree!)

It is not well to take all this too much to heart, however. Although many mistakes have been made, and will always be made, this low-loss propaganda, discussion, or whatever one may wish to call it, has certainly inspired plenty of enthusiasm for the study of radio. Let us hope that there will be more such arguments, not for the purpose of misleading the radio reader, but to arouse his enthusiasm and his desire to learn more about radio. In this connection, it is interesting to note that there has never been, in the history of the world, any branch of science that has roused such widespread interest as radio. There have been other things as, for instance, the telephone and photography, but the greater part of those who were interested by these inventions were *not* interested in the development of the technique. They were only interested in the telephone in a commercial way or in photography as a source of pleasure or passing interest.

When Charging Batteries—Think!

By DAVID E. SHETRON

I AM writing this appeal to every radio fan and every automobile repair garage, or wherever batteries are charged, in the interest of better reception of radio programs.

I had occasion last week to visit a friend of mine in the central part of Pennsylvania and, as he lives out where there is little likelihood of interference, I thought it a good plan to take the radio set along and get some idea of what real reception is. Where I live I am troubled with all sorts of noises, due chiefly to leaky high-power transformers.

After putting up my aerial and getting started about 7:30 P. M., I noticed a noise similar to static, but of a steady grinding. After looking over my set carefully to see that no connections had been jarred loose on the trip, I decided it was an outside noise, not caused by atmospheric disturbances. I inquired whether there were any high-power wires running near the house and was told that the nearest were about five squares away. Then I started to investigate and found my trouble! There was a repair garage about five blocks away that had a 6-volt battery on charge. I thought this a good opportunity to do some experimenting for, as there was a phone in both residence and garage, we had good communication for experimental work.

First I will describe the kind of battery-charger that was in operation at this station.

It was stationary, of the vibrating type, and built in by the owner; it had an instrument to regulate the ampere charge and two single-pole knife switches by which a 6- or a 12-volt battery could be charged alternately. I had the owner of the set pull out the switches to see if there was any other interference and, to my surprise, found the air very quiet. Then we started the charger on a 2-ampere charging rate and found the same noise, chiefly confined to wave-lengths below 300 meters. Then we increased the charge to 7 amperes and found that the grinding increased in volume and was confined to below 400 meters. Next we changed to the 12-volt battery on a 10-ampere charge and found the noise greater than ever and interfering all the way up to 500 meters; above this wave-length the interference was not so noticeable.

Now—what would have been the interference in a city where there are thousands of sets and many charging stations in operation? This, I believe, is where a considerable amount of noise comes from today, which we now ascribe to other causes.

So, if you have a battery to charge and you have a vibrating charger, why not try to charge it during the day-time—and inform the automobile men in your neighborhood to do the same? If we try to inform each other of some of the many causes of interference in radio reception, we shall

eventually get better results and the noise-makers will, in time, disappear. The man to whom I refer readily agreed not to charge any more batteries at night, although he does live in a sparsely-settled locality.

I appeal to all radio fans to co-operate in eliminating this battery-charging noise which, in my opinion, is giving more trouble to the listening-in public than we now realize.

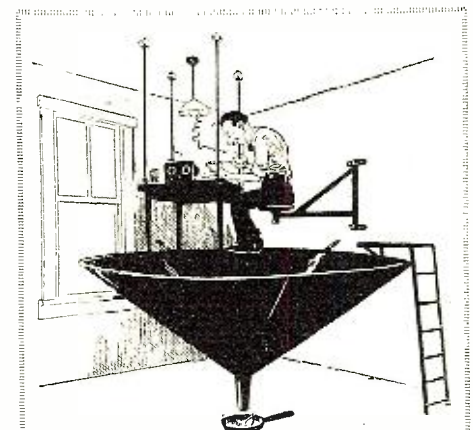

The latest for the fan who builds all the hook-ups as they are published.

A Three-Range Receiver

By the Laboratory Staff of Radio News

RADIO NEWS takes pleasure in introducing to the radio public the three-range receiver herein described. It is very simple in construction and operation.

IT will most likely be necessary in the near future for the radio fan to extend the range of his receiver from 600 to 200 meters, as it is now, to 600 to 150 meters. The ether is becoming more and more crowded, and to provide channels for all the broadcast stations it will be necessary to extend the range. This has been described somewhat in detail in the last issue of RADIO NEWS.

RADIO NEWS will endeavor, from month to month, to give to its readers some of the methods by which the various types of receivers may be made to cover this great range of wave-lengths. Although it is not difficult to cover the range, there are other problems that arise at the same time which must be solved.

CONGESTION

One of the main difficulties which will arise is that of congestion. A little consideration of the frequency range will make this apparent. Six hundred meters is equivalent to 500 kilocycles, and 150 meters is equivalent to 1,500 kilocycles. The frequency range of the receiver, therefore, must be 1,000 kilocycles. At the present time broadcast stations are allocated on frequencies 10 kilocycles apart, so that in this total range there will be 100 channels in which the stations may operate. It will be next to impossible to tune with the circular plate condenser to the stations having the shorter

wave-lengths. The crowding at the lower dial settings will be worse than ever. Even

HERE is a set which we heartily recommend to the radio fraternity. As is well known, most sets work at their full efficiency only at a certain wave-length. The usual broadcast set, as a rule, works best at about 300 meters. With the present set we get maximum efficiency on practically ALL wave-lengths. The volume of the set is tremendous, and its DX efficiency is remarkable. In a single evening in New York City, using a mediocre aerial, over twenty-five stations, some 2,000 miles distant were received on the loud speaker. The set is easily constructed by anyone. We should like to hear from readers who have constructed this set as to what records and what performance they have been able to make. —Editor.

if a straight-line frequency condenser be used in the tuning circuit, and half the dial circumference divided into 100 divisions, there will be one channel for each division on the dial, which is about as closely as one

can tune with comfort. (See June issue of RADIO NEWS.)

However, it is apparent that we would not have the whole dial to tune over, for in the average variable condenser, a motion of from 5 to 10 divisions is required before the plates are in mesh and the condenser begins to act as a true straight-line frequency condenser. It is apparent, therefore, that we must not count on more than about 90 divisions on the dial for accurate tuning.

Even at that there should be no difficulty tuning over the whole range when a straight-line frequency condenser is used. At the present time, however, these are not generally available, and the straight-line wave-length type is just as bad as the circular plate condenser, so that for the present other methods of spreading out the stations must be found.

A "THREE-RANGE" SET

In the set to be described in this article the range is divided into three parts, making it a three-range tuner. The calibration of the set is shown in Fig. 1, where each of the curves applies to one of the three points on the switch which is used to change from one range to the other. The first point of the switch gives a range from 600 to 400 meters approximately; the second point gives a range from about 440 to 200 meters, and the third point gives an approximate range from 240 to 140 meters.

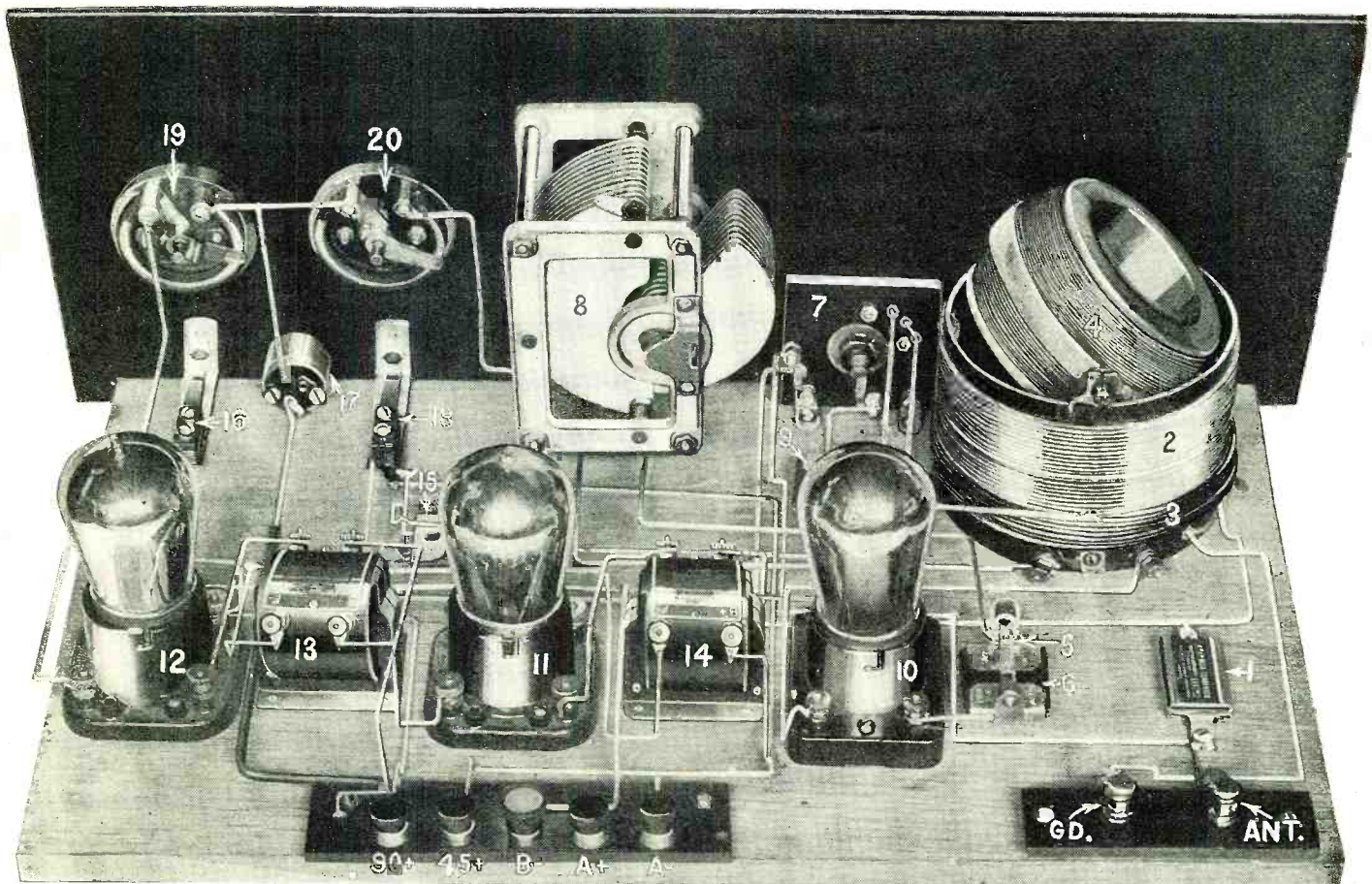

Rear view of the three-range receiver. The numbers on the instruments correspond to those given in the caption on the opposite page.

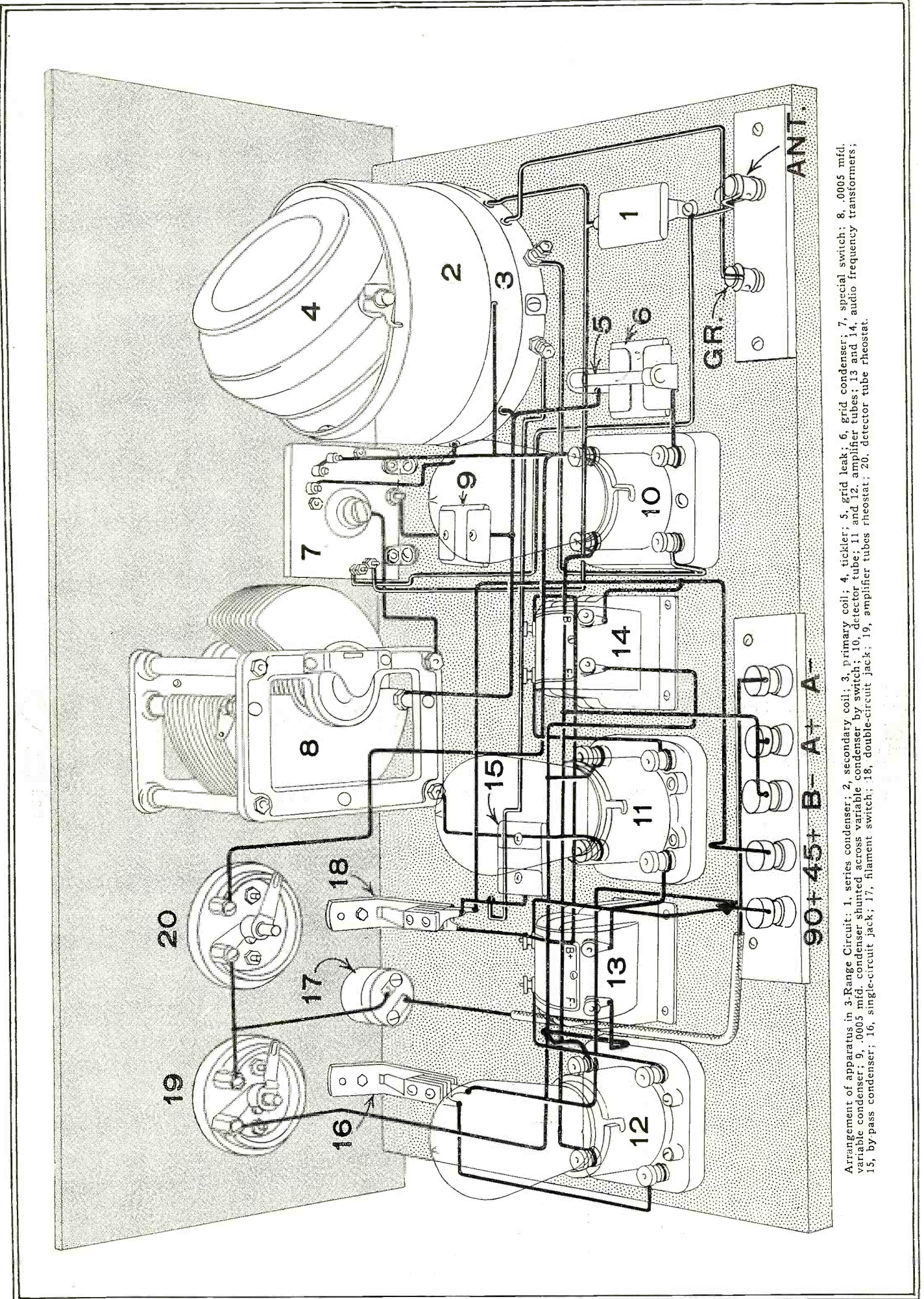

Arrangement of apparatus in 3-Range Circuit: 1, series condenser; 2, secondary coil; 3, primary coil; 4, tickler; 5, grid leak; 6, grid condenser; 7, special switch; 8, .0005 mfd. variable condenser; 9, .0005 mfd. condenser shunted across variable condenser by switch; 10, detector tube; 11 and 12, amplifier tubes; 13 and 14, audio frequency transformers; 15, by-pass condenser; 16, single-circuit jack; 17, filament rheostat; 18, detector tube rheostat; 19, amplifier tubes rheostat; 20, detector tube rheostat.

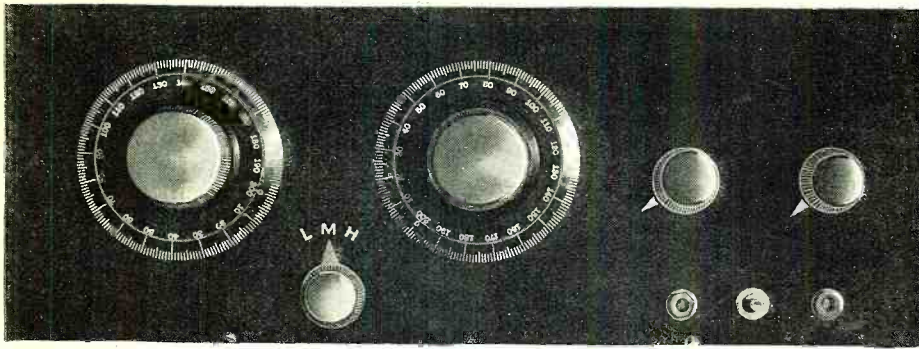

The front panel view presents a pleasing appearance.

Each of these three ranges is covered completely by the whole condenser dial, so that the 1,000 frequency channels are spread out over three dials, as it were, and there is not much likelihood of crowding with this arrangement.

The method used is shown very clearly in the wiring diagram. A special switch was constructed for the purpose, which anyone can make of scrap parts lying about the workshop or laboratory.

The coil used in the tuner was wound with ordinary bell wire. There were 30 turns of this wire on a 3/4-inch tube. The tickler or rotor was of the ball type, which can be purchased anywhere, and had on it 15 turns of No. 18 D.C.C. wire. The secondary coil was tapped at the 20th turn as shown in the wiring diagram.

The variable condenser used had a capacity of 0.0005 microfarad.

On the first point of the switch a fixed condenser having a capacity slightly less than 0.0005 microfarad is connected in parallel with the variable condenser, so that we are tuning the coil with a condenser having a maximum capacity of 0.001 microfarad. When the variable condenser plates are entirely out of mesh, the capacity in the circuit is equal to that of the fixed condenser. The whole coil is used on the first switch-point.

On the second point of the switch the fixed condenser is thrown out of the circuit, so that the coil is tuned by the 0.0005 microfarad variable condenser alone.

On the third switch-point, the variable condenser is allowed to remain in the circuit, while the coil is cut down by the tap shown in the diagram. To get down to the shorter wave-lengths it is necessary to reduce the inductance in the circuit as has been done in this circuit.

It will not be necessary to go into the

Following is a list of the parts necessary for the construction of the three-range tuner described in the accompanying article:

- 1—Variocoupler—wound as shown.
- 1—.0002 fixed mica condenser.
- 1—.00025 fixed condenser and grid leak.
- 1—.001 by-pass condenser.
- 1—.0005 variable condenser.
- 3—Vacuum tube sockets and tubes (201A type).
- 2—Audio frequency transformers.
- 1—Single-circuit jack.
- 1—Double-circuit jack.

Brass, bakelite and switch-points for construction of multi-point switch, bus-bar binding posts, panel baseboard, screws, nuts, etc.

construction of the remainder of the circuit. This has been assembled in the usual manner, and consists of two stages of transformer-coupled audio frequency amplification.

The construction of the switch is shown very clearly in Fig. 2. It will be noted that there are three prongs of the switch not connected to the switch shaft, which make contact with two points connected to a fixed condenser in the antenna circuit.

This fixed condenser has a capacity of 0.0002 microfarad, and is used to reduce the natural wave-length of the antenna circuit. This was found to be necessary in calibrating the set, on the third point of the switch, for the shorter wave-lengths. The ordinary antenna, as generally used, did not seem to function as satisfactorily on the shorter wave-lengths without this series condenser. It is short-circuited on the first point of the switch and also on the second point. It is only when we come to the third point that it is necessary to break the short circuit.

The sequence of operations is shown in Fig. 3, giving the three circuits corresponding to the three positions of the switch.

The operation of the set is comparatively simple. For the first band of waves reaching from the top of the broadcast range to about 400 meters, it is only necessary to set the triple-point switch in the first position and rotate the variable condenser through 180 degrees in the usual manner. When the operator wishes to drop to the lower wave-lengths in which the majority of the class C stations are located, namely

(Continued on page 120)

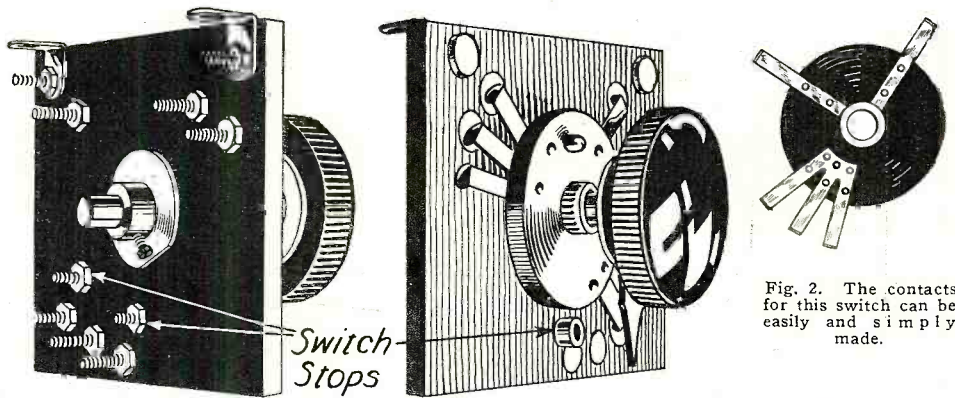
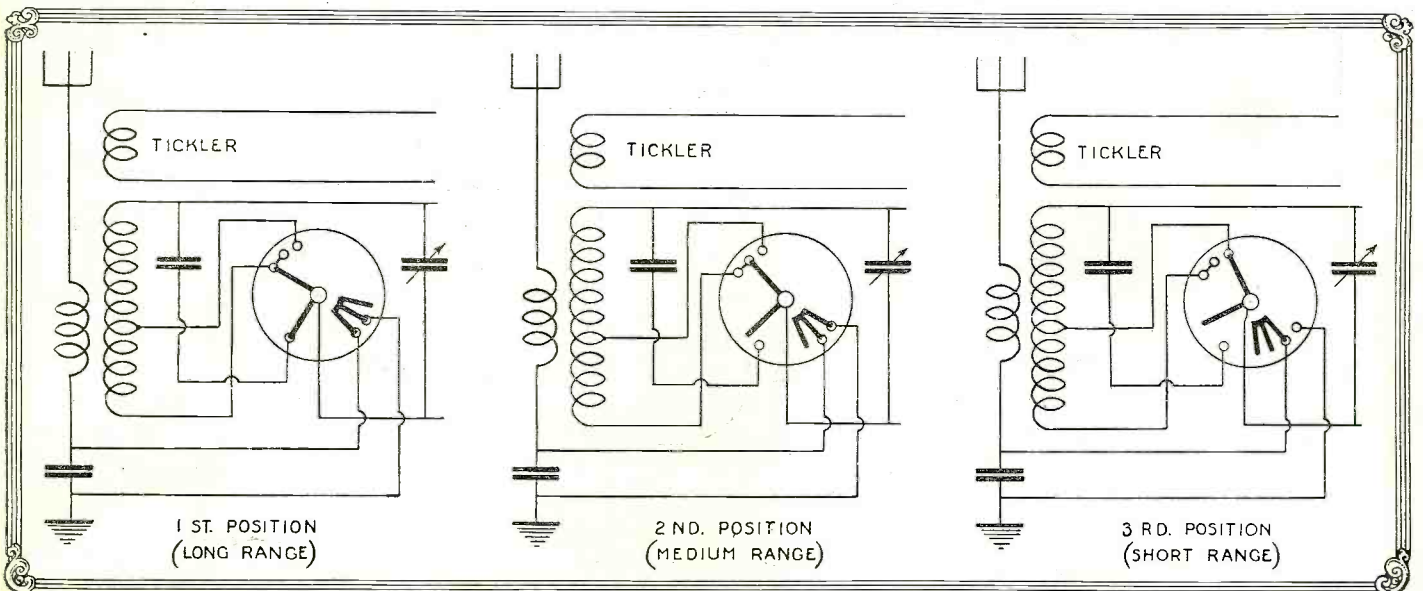

Fig. 2. The contacts for this switch can be easily and simply made.

Fig. 3. The diagrams below show the switch in the three different positions. The ranges are approximately: 1st position, 600 to 400 meters; 2nd position, 420 to 220 meters; 3rd position, 240 to 140 meters.



TRANS-ATLANTIC RE-BROADCASTING

NEWEST BRITISH BROADCAST STUDIO. Right: The British Broadcasting Co. has erected at Savoy Hill, London, their new studio from which programs were broadcast for relaying to the United States.
© Underwood & Underwood.

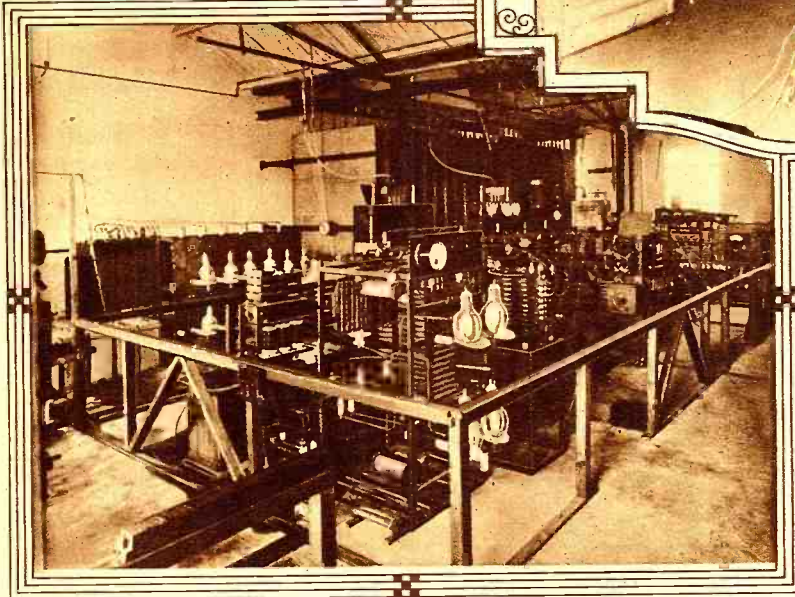

BRITISH STATION 5XX. This station at Chelmsford using 25 kw. power, put the programs on the air for American reception. This interior view of the station shows plainly the tubes and other apparatus used in the transmission. © Kadel & Herbert.

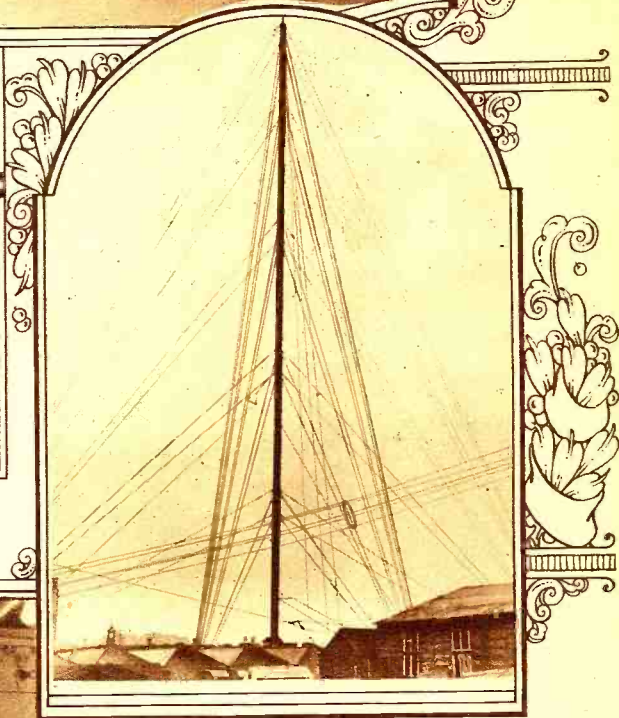

ANTENNA MAST AT 5XX. The above shows one of the 400-foot masts at the experimental station at Chelmsford, where the programs were put on the air, after being sent by land wire from London. © Kadel & Herbert.

RECEIVING EQUIPMENT. Right: The high-powered station at Belfast, Maine, is here shown. The 1600-meter waves were received here and re-broadcast on a short wave-length. The short waves were then received at the experimental station of the R.C.A. in New York City. © Kadel & Herbert.

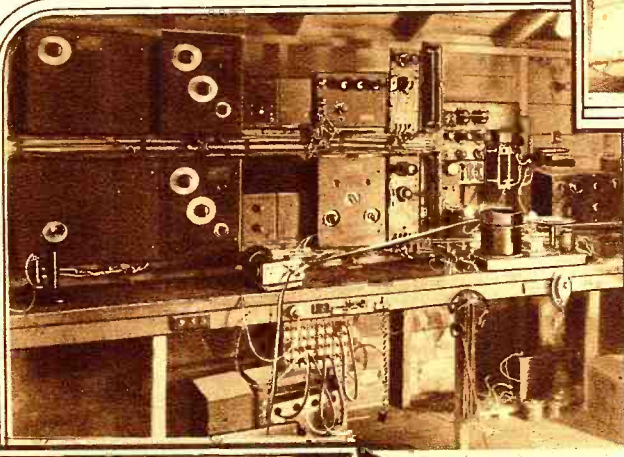

SHORT-WAVE RECEIVER. Left: Where the short waves broadcast from Belfast, Maine, were received and sent on land wires to stations WJZ and KDKA for re-transmission on their normal wave-length. © Kadel & Herbert.

CONTROLS AT STATION WJZ. Right: The amplifier panel. © K. & H.

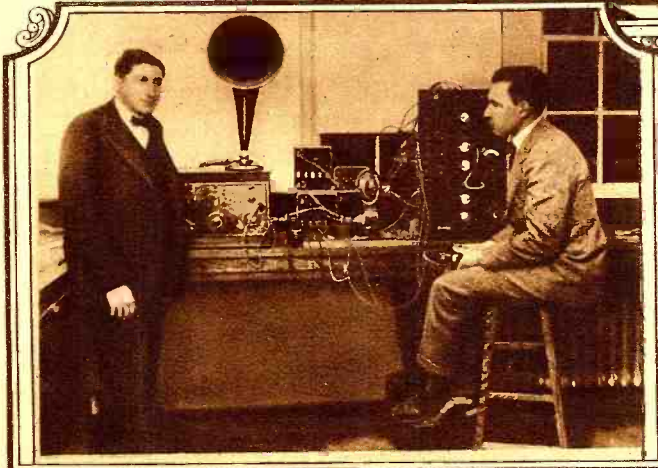

Radio News—WRNY—

THIS month sees the debut of the RADIO NEWS new broadcast station, WRNY, situated atop the Roosevelt Hotel, at 45th Street and Madison Avenue, in the heart of New York City.

WRNY OPERATES ON 258.5 METERS (1160 KILOCYCLES) POWER 500 WATTS

As might be expected, this station will be one of the most novel, most efficient, and most interesting stations in the country. For completeness of equipment, output and general design, it will be surpassed by very few stations now in operation.

Several novel features which never before have been incorporated in any broadcast station are to be included.

As to apparatus, the main transmitter is the standard Western Electric Unit employing two 250-watt oscillators and two 250-watt modulators in the standard Heising circuit, with Hartley oscillators. The power supply is especially designed for the transmitter and is built entirely in duplicate so that, should anything be amiss with one unit, the other may be thrown in instantly at the power panel and listeners would, therefore, be unaware of any accident at the broadcast station. It will be seen, by reference to the schematic diagram, that the two power units feed into the power panel where the supply is metered and controlled. On this panel is also situated the remote controls for operating the generators and controlling their output. These two coil units consist of motors for power, a high tension generator which comprises two windings, each delivering a little over 1,200 volts, and a filament generator which supplies the necessary heating current to the tubes at approximately 15 volts. The generators are housed on the 20th floor of the hotel, while the studio is on the opposite side of the building on the 18th floor.

This is simply following out the policy decided upon when the decision was made to erect the broadcast station. The station being a part of the magazine, it was thought logical that it should be made somewhat a magazine of the air and going upon this assumption, plans were made accordingly.

(Continued on page 109)



Above is shown the control board for the hotel public address system. Through the agency of this system it is possible to introduce any program being given in the studio of WRNY into any of the public rooms of the hotel or to pick up speech from any room in the hotel and put it on the air through WRNY.

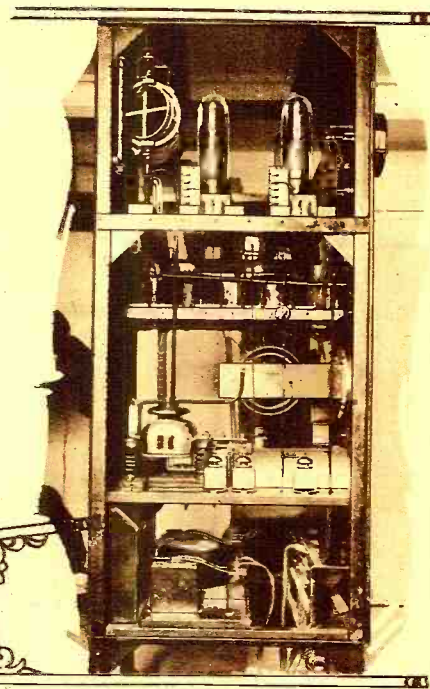

Above is the main transmitter, which puts the signals on the air. It is the standard Western Electric type with two 250-watt oscillators and the same equipment on the modulation side. In the extreme upper left-hand corner of the set may be seen the harmonic suppressor, the very latest in transmitting stations. Below is a schematic diagram of the complete arrangement of the station, showing the interconnection of the various pieces of apparatus which go to make up the complete unit.

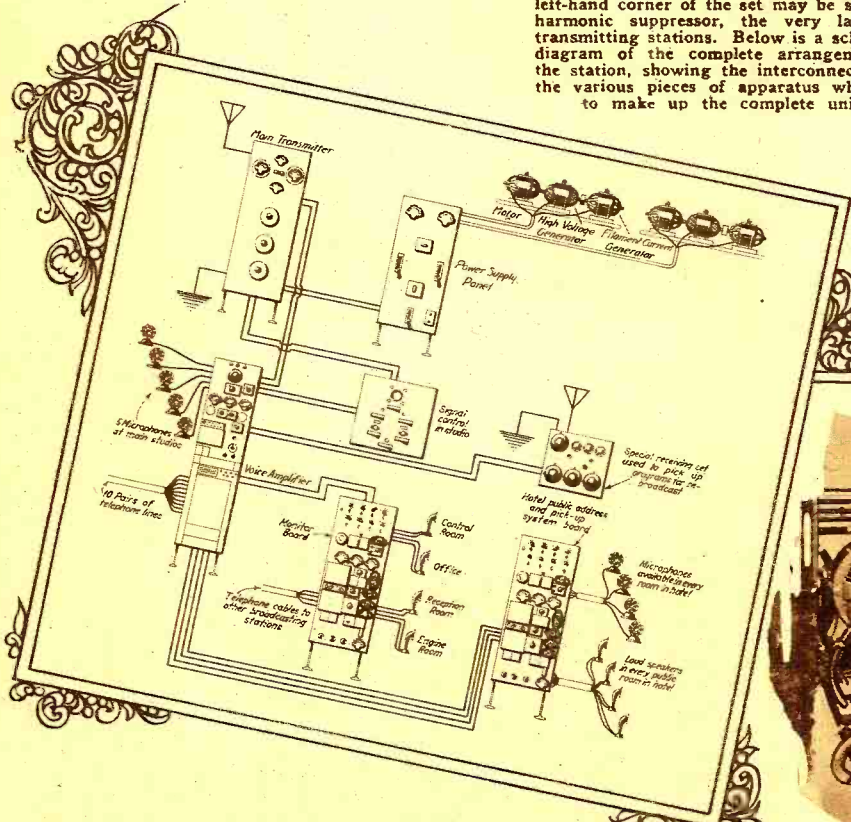

At the right is the dual power supply, which furnishes the power for the station. The conduit, which is visible at the rear of the photograph, contains the wires carrying the power from the units, and the remote control for starting and stopping the motors and generators.

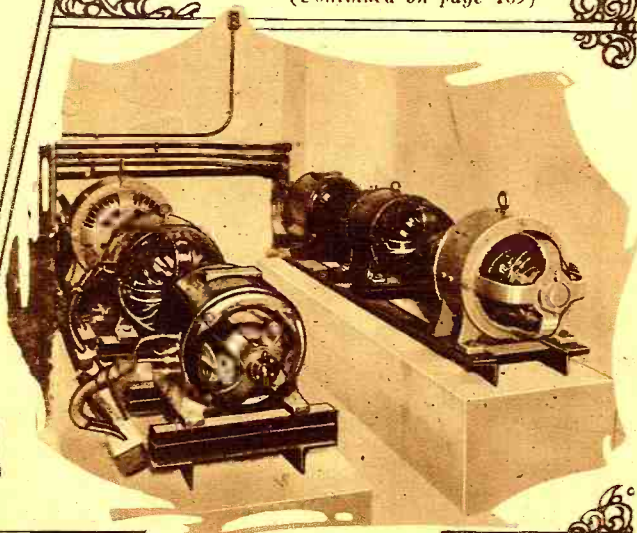

Goes On the Air

TRANSMITTER

Standing next to the power panel in the control room is the main transmitter, the chief input panel, the 600-meter watch receiving station, monitor controls, and pick-up radio receiving station on which other radio programs may be picked up and re-broadcast. In the main transmitter there are several innovations, one of the chief being an harmonic suppressor which entirely rids the broadcast modulator carrier wave of all mush and harmonics, usually found so troublesome. This device is indicated in the photograph. The lightning arrester, curious as it may seem, is nothing more than a 4,000-ohm resistance connected between the aerial and ground terminal. Tuning frequency regulation and percentage of modulation are all controlled from the current of the panel. In order that the emitted wave may remain always at the assigned frequency, a special

(Continued on page 109)



At the right is the modulation panel and the main transmitter panel, the latter in the background. Note the tubes and the controls on the voice amplifier. It is here that the incoming voice from the studio to telephone lines is amplified and passed on to the transmitter. Sixteen pairs of telephone lines come in at the bottom of the board and may be connected, at a moment's notice, to the amplifier. This makes distant programs anywhere available to the station.



WRNY

"The Novelty Station"

Outstanding Facts About WRNY:

¶ The first high-class high-power station going on the air, on a decidedly low wave-length, of its own volition.

¶ A novel feature, by which you will recognize Station WRNY between numbers, is its constant "Staccatone" signal, which will be on the air before the announcer speaks and after selections. DX listeners-in will immediately recognize the special WRNY signal, even before the announcer speaks.

¶ The first station to be interconnected with a hotel public address system. Entire hotel can listen-in to what is going on at the studio, and special orchestra selections and banquets taking place in the hotel can be switched on instantly.

¶ The first station to broadcast complete radio hook-ups. Information elsewhere in this issue.

¶ WRNY answers radio questions over the air.

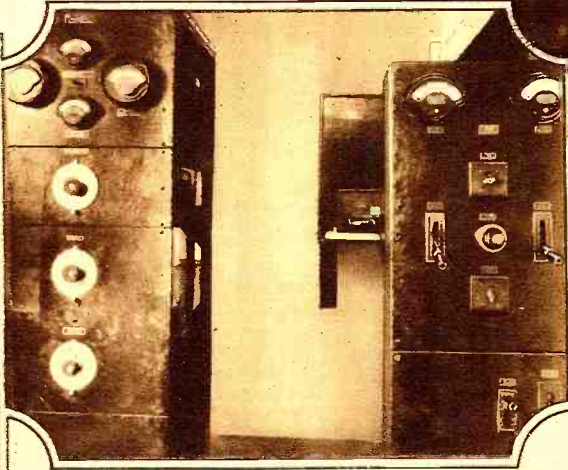

Below is the commercial watch station where an operator is always on duty, listening-in on the 600-meter band for SOS signals and keeping a watch on the ether all the time the station is in operation. This is also the position of the special receiving station for picking up programs from other stations for re-broadcast.

Above is shown the adjacent positioning of the power control panel and the main transmitter. Should anything go awry, it is only necessary for the operator on watch to step over to the power supply panel to cut it off. By this arrangement an instant change-over from one power unit to the other is also possible and, consequently, no interruption in the program is necessary.



At the left is the control-box in the studio, with pilot lights to indicate the operation of the station at all times. There is a system of lights on the face of the box which serves as a perfect guide for the announcer. It is also equipped with an extension cord and a push-button by which the announcer can be in control of the station from any corner of the studios.



Radio in Old Cathedral

NOTRE DAME DE PARIS. Left: This cathedral on the banks of the Seine that has been famous in history for over 700 years has finally been modernized. Loud speakers have been installed in the nave of the cathedral so that the congregation may hear the services. © Underwood & Underwood.

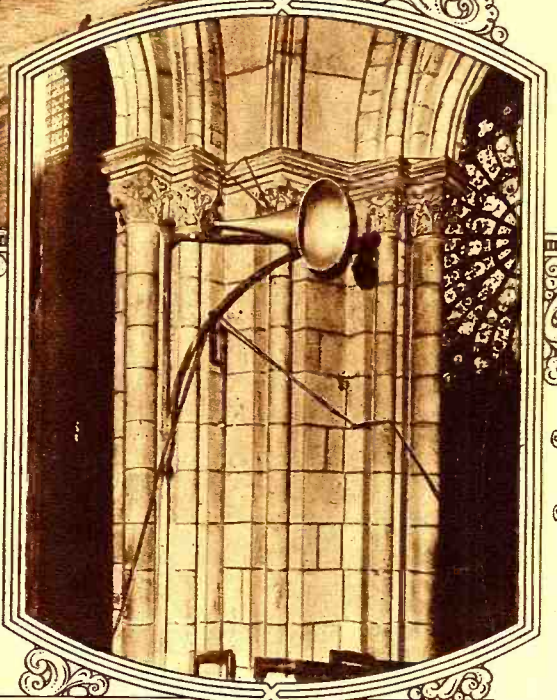

LOUD SPEAKER INSTALLATION. Right: One of the loud speaker horns mounted on a pillar near the chancel of the cathedral. One of the famous rose windows may be seen in the background. © Underwood & Underwood.

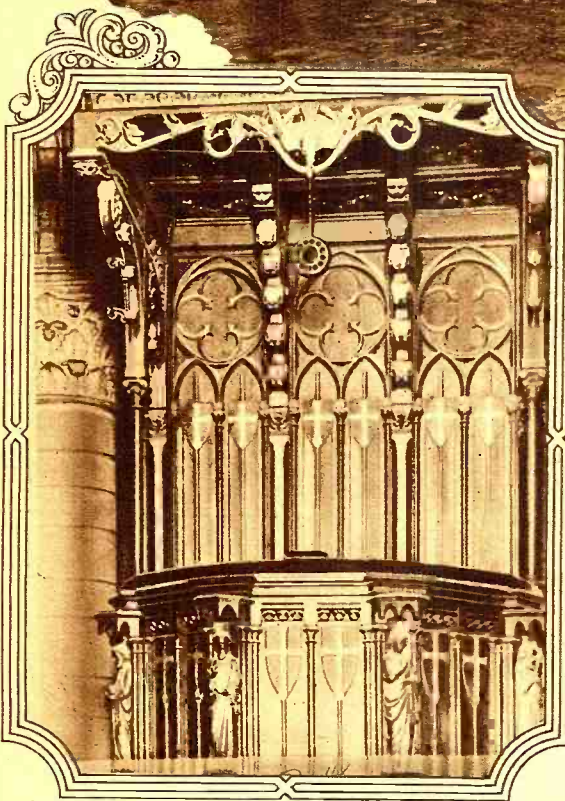

MICROPHONE ABOVE PULPIT. Left: The pick-up apparatus in the cathedral. The microphone is shown over the pulpit that was designed by Viollet-le-Duc and executed by Mirgen. © Underwood & Underwood.



"RADIO CZAR" OF JAPAN. Viscount Shimpeo Goto, formerly Home Minister and Foreign Affairs Minister, who is the President of the newly formed Tokyo Radio Broadcasting Bureau. © Keystone View Co.

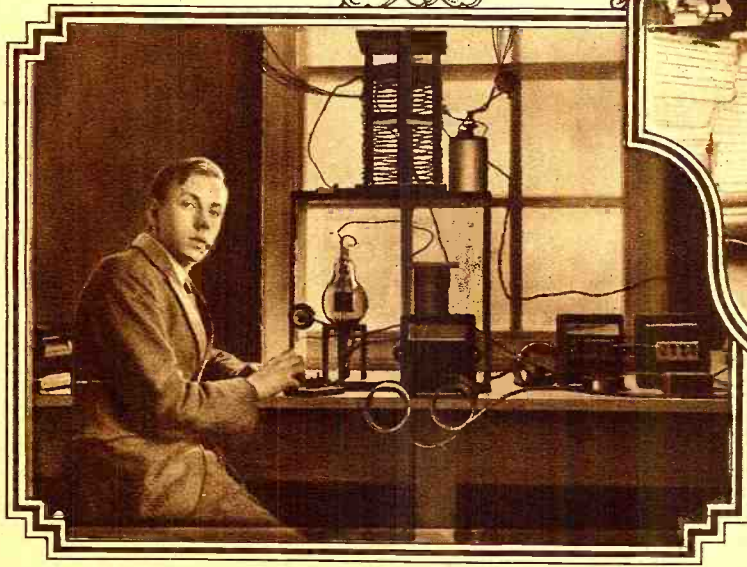

ENGLISH SCHOOLBOY WORKS WITH AMERICA. Left: C. W. Goyder, of Mill Hill School in England, has worked several amateurs' stations in this country and many stations on the Continent.

Radio in the United States Navy



WIND-DRIVEN GENERATOR ON AIRPLANE. In the enclosure is shown the single-bladed and self-regulating generator that supplies power for the radio transmitting and receiving apparatus for Navy airplanes. Courtesy Naval Engineering Dept.

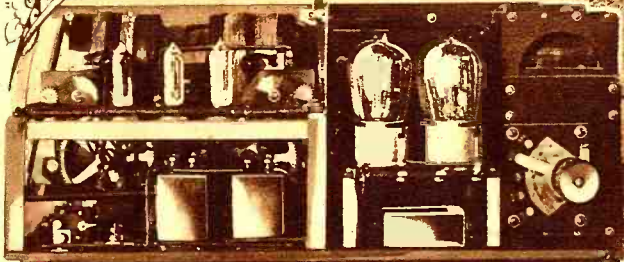

AIRPLANE TRANSMITTER AND RECEIVER. Interior view of set showing on the right the four 7½-watt transmitting tubes and on the left the three peanut tubes used for receiving. Courtesy Naval Engineering Dept.

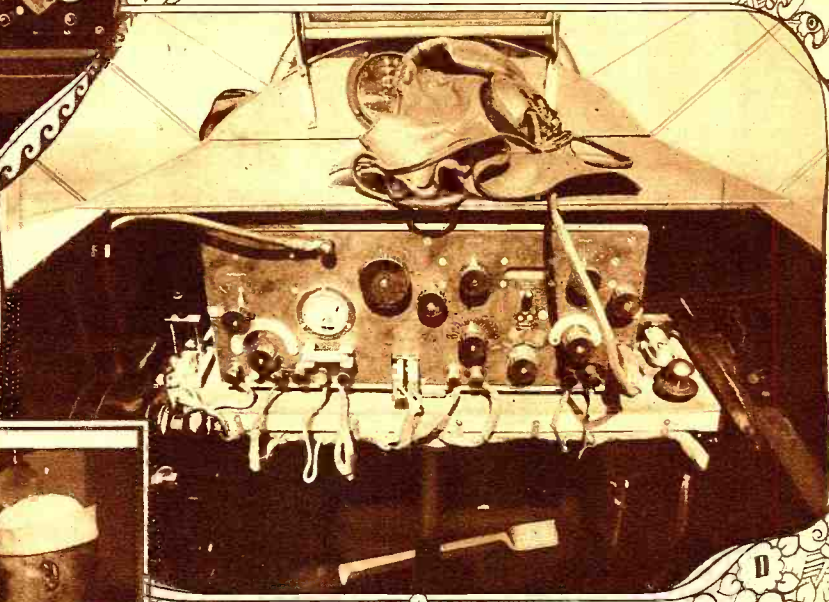

INSTALLATION OF SET IN AIRPLANE. The weight of the complete radio equipment is 88 pounds, which includes the set, generator, antenna, reel, antenna weight, aviation helmet, head telephones, sending key, and batteries. Courtesy Naval Engineering Dept.

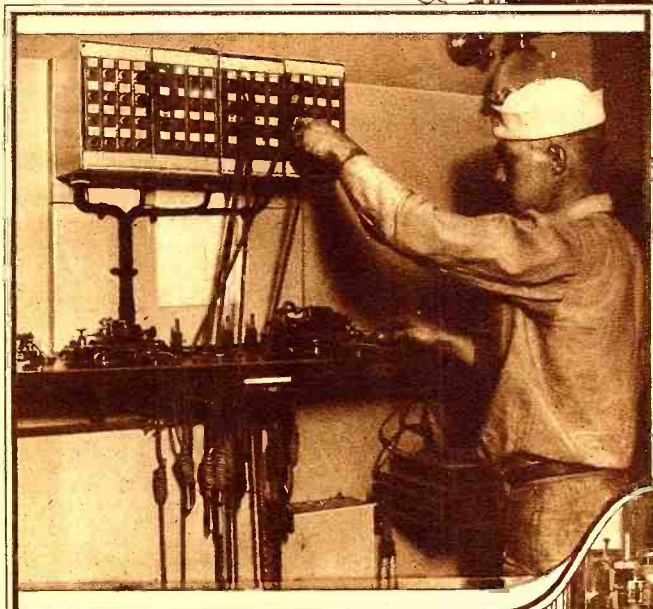

SIGNALS FROM THIS STATION HAVE BEEN HEARD 8000 MILES. Above is shown the relays that automatically control the transmission of the time signals twice daily from Station NAA at Arlington, Va. On the right is the 100 kw. equipment that supplies the power for Station NAA, which is used for broadcasting hydrographic information, Shipping Board messages, as well as the well-known time signals. © Underwood & Underwood.

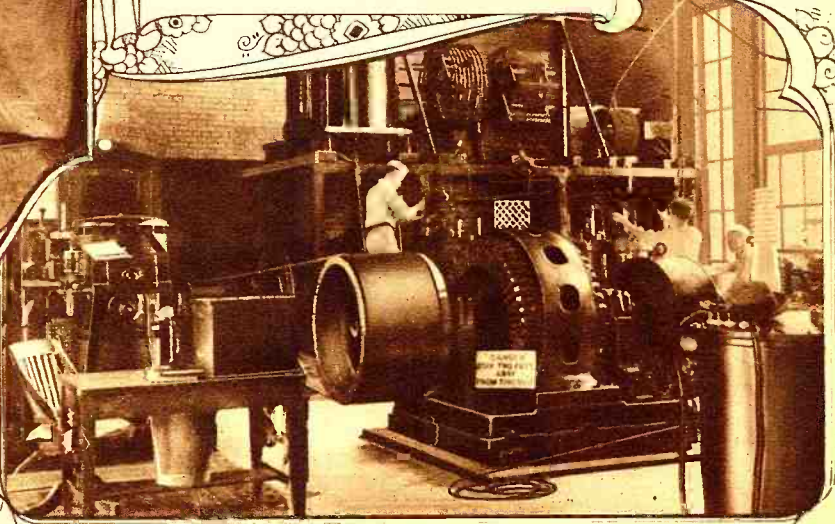



NEW YORK THEATRE USES RADIO FOR RESERVING SEATS. Left: A national chain of vaudeville houses have installed radio for inter-theatre communication, as well as seat reservations. © Underwood & Underwood.



AVIS RARA BROADCASTS. Right: The "Troupial" that is perched blithely on the microphone is the first of the species ever to broadcast its song from a radio station, although along the Amazon River its song is a common occurrence to the jungle inhabitants. © Kadel & Herbert.

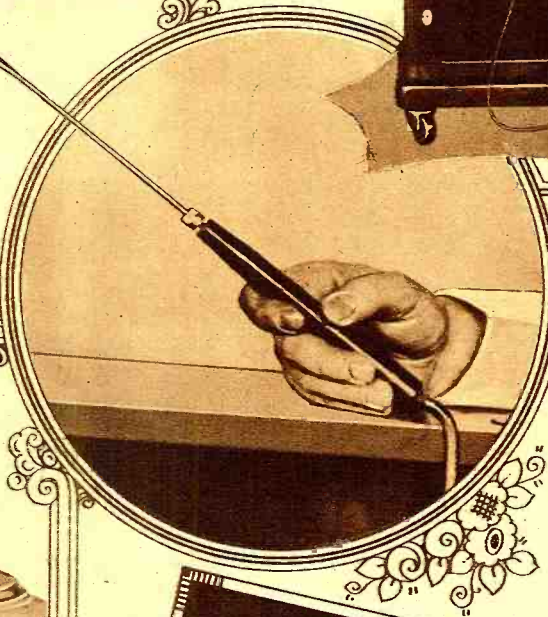
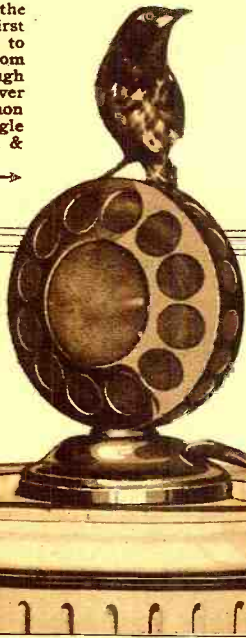

RADIO KNIFE USED IN CANCER TREATMENT. Above is shown Dr. Jos. F. Elwood of the Boston City Hospital with the radio knife and apparatus for its operation. The knife, which is shown on the left, is tuned in like a radio set and operates on alternating current. © International Newsreel.

DOLLY BROADCASTS. The two-year-old elephant shown below is rehearsing her part in the circus radio program recently broadcast. © International Newsreel.

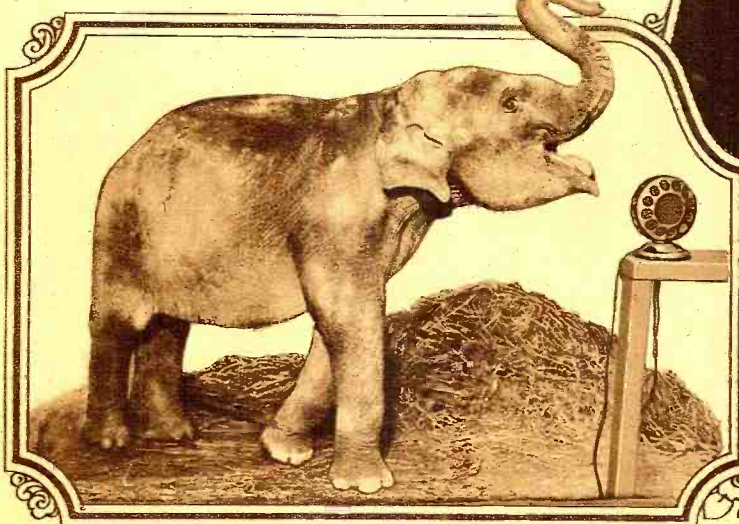

OPENING THE 1925 BASEBALL SEASON. Hank Gowdy, catcher of the N. Y. Giants, broadcasting before the game with the Boston Braves. © Underwood & Underwood.

HEAD OF FRENCH ARMY RADIO DEPARTMENT. General Ferric, who heads the telegraphic operations of the French army including the radio station that is located in the Eiffel Tower in Paris, experimenting in his laboratory. © Wide World Photos.

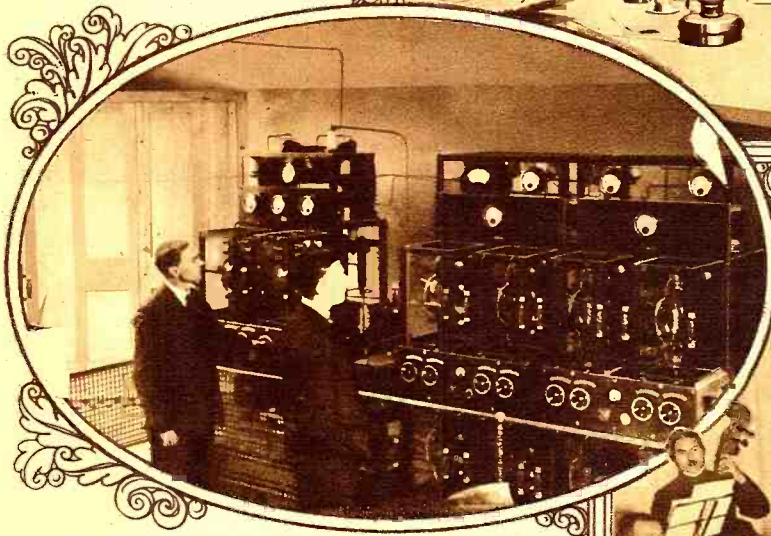
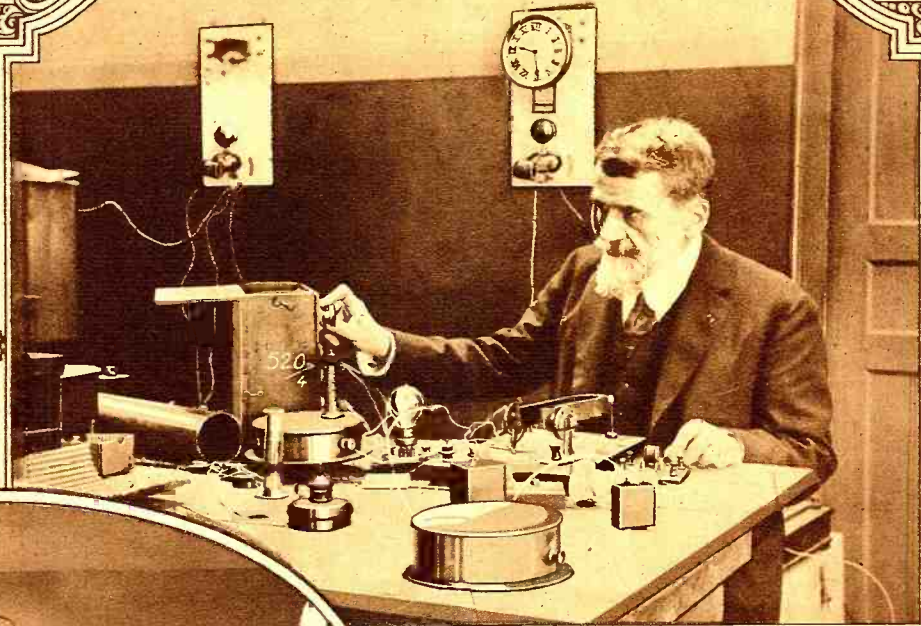

THE NEW HOME OF STATION 2LO. Above is shown the transmitting apparatus of the London station in its new home. Below are shown the antenna masts over Selfridges. © Wide World Photos.

JAPANESE BAND BROADCASTS JAZZ. Below: The Japanese Naval Band in the Tokyo studio, broadcasting for the first time this type of music. Radio development in the Far East, where the varied language might easily be confused with static, is slow. © Henry Müller News.



RADIO AT THE PANAMA CANAL. Below: A field radio set located at Pedro Miguel Locks. Radio plays an important role in the Canal's defences. © Kadel & Herbert.

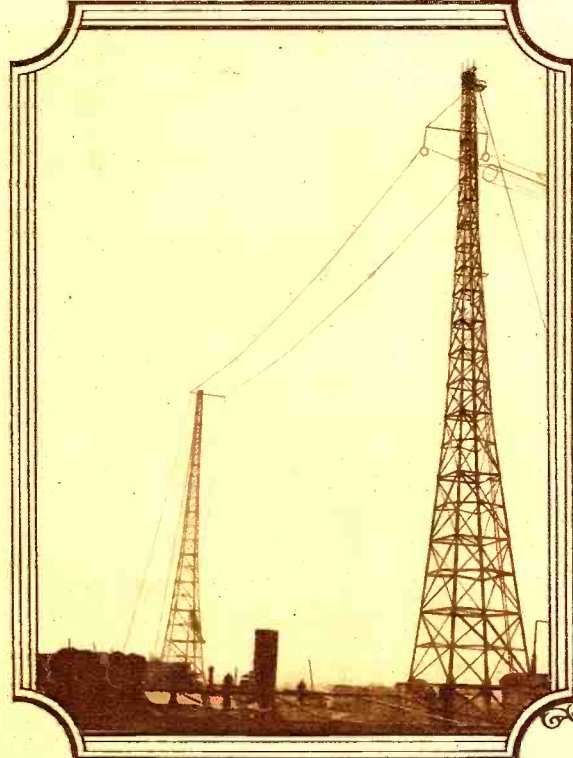
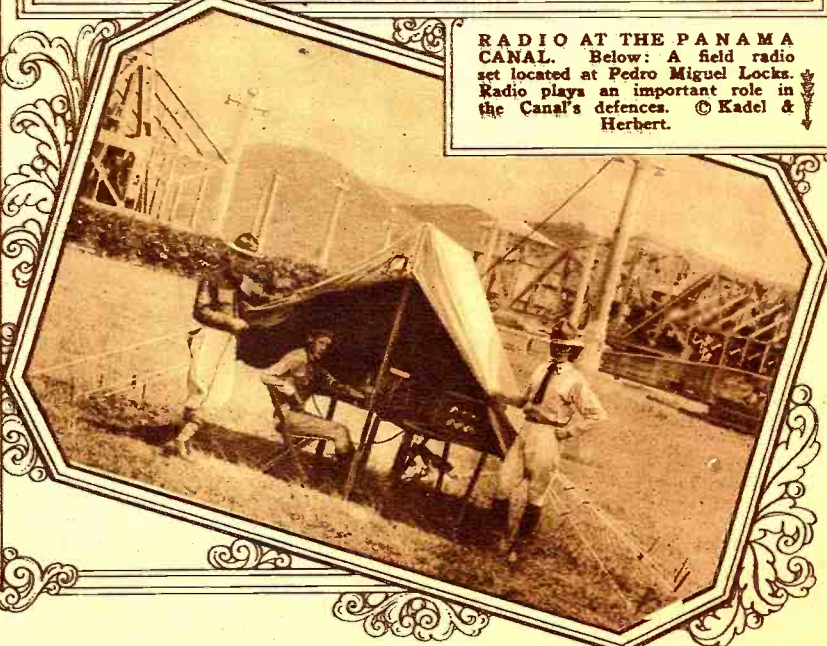



RADIO AT WELLSLEY COLLEGE.
 A course that has recently been added to the Physics Department curriculum is the study of the principles of radio communication. Students construct both transmitting and receiving sets; the two upper photographs, taken in radio laboratory, show sets under test. In the circle are shown two students making a test on a radio direction-finder.

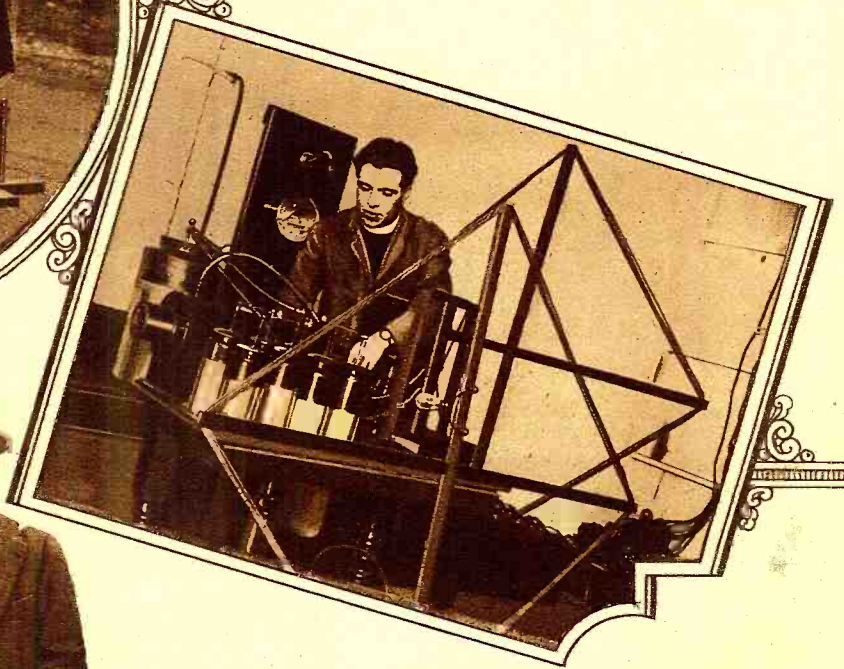

LIGHTS ELECTRIC LIGHT BULB BY RADIO. Above is shown Rev. M. T. Beckett, an English clergyman, who has succeeded in transmitting sufficient power by radio across his laboratory to light an ordinary lamp. © P. & A. Photos.

CONTROLLING AIRPLANES BY RADIO. Left: Secretary of the Navy Wilbur directing the movements of airplanes by radio at Quantico, Va. © Henry Miller News.

The Juice Hangs High

BY ROBERT FRANCIS SMITH

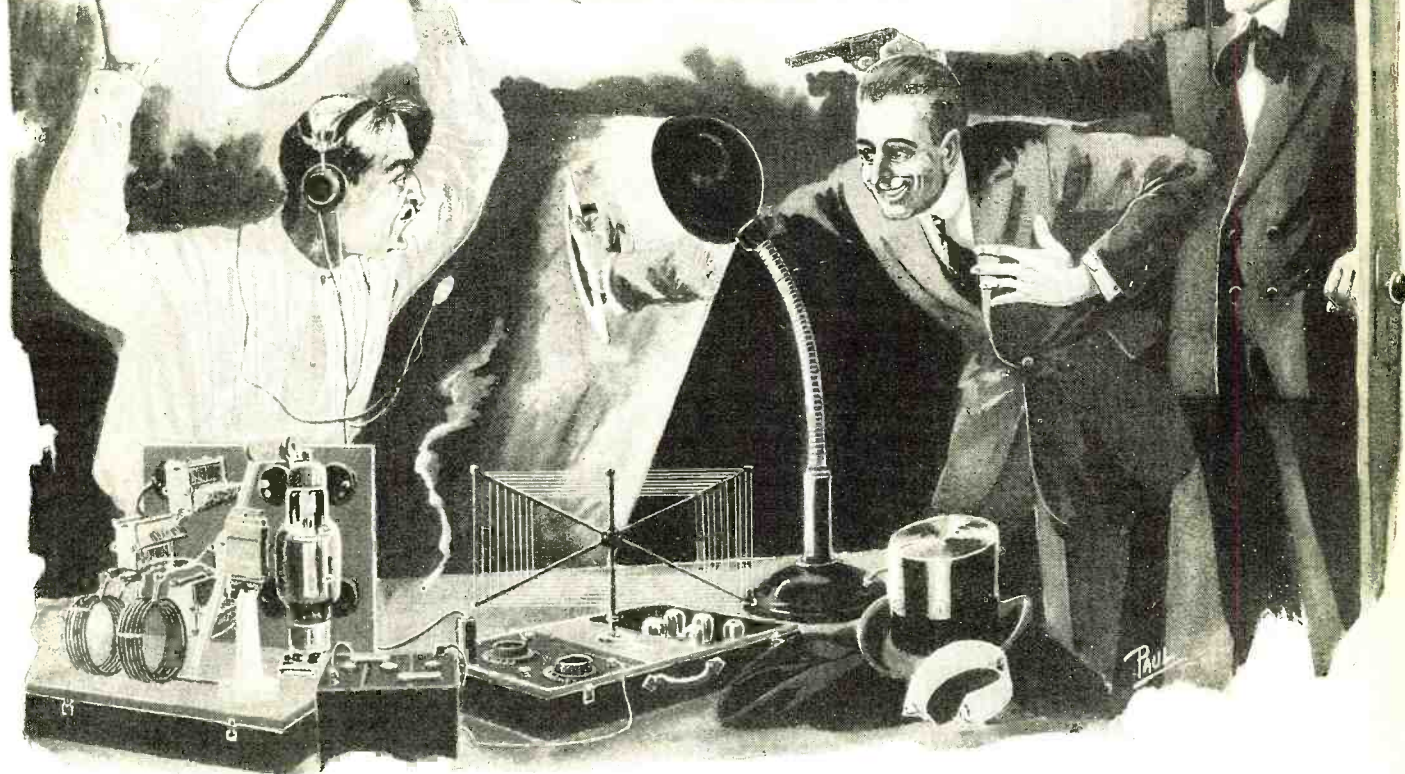

"A radio, a hook and line, a scow,
Oh, baby, that'd be the cat's meow!"

THE foregoing strain on the voice-box is my own arrangement of a little dirty popularized by a small-time cigarette-maker named Omar, who did his turn back in the days when they used ox teams for ether waves. And on a July afternoon, when the heat is warping grids in vacuum tubes and the humidity keeps you doing an imitation of a sponge under pressure, I ain't afraid to yelp "them's my sentiments, and no kiddin'."

My paternal ancestor once philosophized into my juvenile ear the following bit of sterling advice: "Son, never play the ponies—equine or theatrical." Whereat I promptly went out and did both, the result being that I lost my bankroll on one of the former and found myself married to a specimen of the latter in her worst stages. Yes, I'm an actor, to be specific, a dancer, and so's my wife, and we're successful enough to be able to lay off summers, and we does, and here I am out in a rowboat at Brightmere-on-the-Deep, trying to tease a coupla fish into sampling the nectar on a ten-cent fly. Oh, yes, my name's Joe Hammerstein, in case we ain't met before, and my legal accompaniment is Doris, at present seated on the front and only piazza on our buyed-a-wee home, broadcasting to the neighbors the newest scandal about some poor frill that never done nothing to her except tell the same line of stuff about her to somebody else. I hopes I makes myself clear; anyway, that's the why of me being out on the briny with a suitcase set and fish-pole, trying to get Chicago and land a batch of fresh salt herring at the same time. Oh, it's

idyllic, as Doris says—whatever that means.

Along about four o'clock I decides I can't tune in nothing bigger than a ten-watt sun-fish, so I dips the oars and ripples in to the dock. Of course, I couldn't be lucky enough to get past the house without my fireside companion spotting me. This individual, oddly alone, is seated on the steps, and lets out a small war whoop when I heaves into view.

"Joseph Hammerstein!" she demands. "Have you been fishing again?"

"Presumably," I replies. "I had my usual no-luck."

Mrs. Hammerstein stands up. "Here I've been waiting for you to come and help get dinner," she complains. "Shake an ankle, Mercury."

I'm despairing. "Dinner?" I repeats. "It's only four o'clock."

"We've gotta date with the McArthurs for evening bridge," explains my speed regulator. Which is just like hooking the "B" battery onto the "A" circuit. I'm blown out.

"We've gotta date!" I echoes. "Since when, and where, was I asked?"

"Never mind, you," snaps Doris. "You'll have to hop into your soup-and-fish. This is a swell party. Remember your p's and q's."

I snorts. "Ain't the rest of the alphabet being used this season?" I grumbles. "I hadda date with The Master to go hunting starfish with a telescope."

"Well, you'll be looking for bridge points with your bare eyes," finishes Doris. "That settles that!"

It does. The McArthurs is one of the ritziest gangs of millionaires that ever sounded a broad "a." A party there means I've gotta mind the book of etiquette and

not draw hook-ups on my cuffs. Doris is thrilled—me, I'm disgusted.

"But honest, honey, I hadda real date," I begs. "Jerry and I—"

"Use your pearl studs, dear," says Doris, sweet. "And don't tie a four-in-hand tie."

And they wonder why some men stays bachelors!

At eight we arrives at the McArthurs, which is precisely like I knew it'd be, only more so. There's the usual crowd of intellectuals that talks about themselves to each other in a way that'd make the most conceited actor on Broadway look like an also-ran. We're well known in town, having lived here last summer, and Doris's having found an English count on her side of the family three hundred years before the Pilgrims staged their front-page landing makes us solid with the up-and-ups. I gotta uncle they calls the "Duke of the East Side," only it seems them titles don't count. Anyway, I ain't mentioned it.

Bridge is a game that looks nice and lets you out on swearing, but it ain't got the stamina of draw poker. I'm outa my element, but I gets by, putting in a word here and there. I'm playing at a table with Doc Maxwell against a team composed of an ancient dowager and an English nobleman tagged Sir Arthur Haviland. During the course of the game this bozo lets out a crack about radio. I sits up.

"Are you a radio fan, sir?" I inquires, stiff. The gentleman gives me the super-hot stare.

"A fan, sir?" he comes back. "Why, really, I don't believe that I have ever been termed that. Fancy! A fan!"

This high-hatting don't go down good
(Continued on page 90)

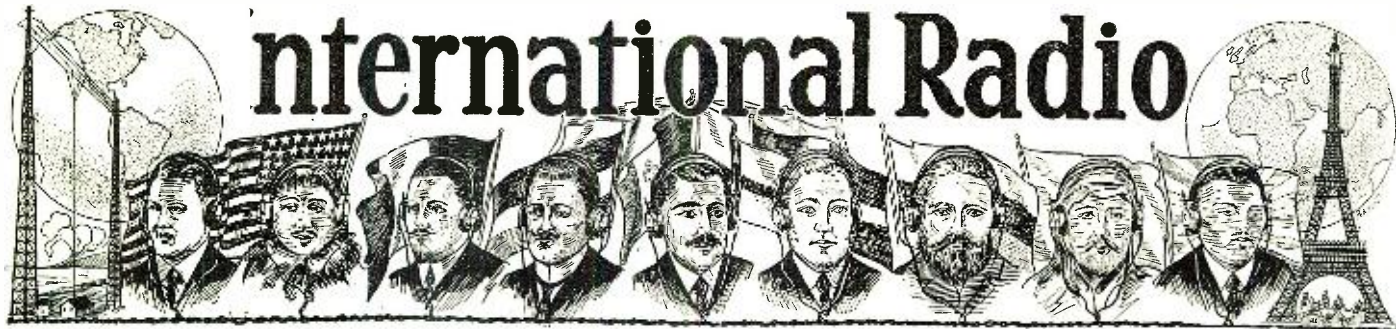

ENGLAND

Paderewski Phonograph Records

After the recent broadcasting of Ignace Paderewski from 2LO in London, he autographed several of his phonograph records, which were offered to the highest bidders. The station was swamped with letters enclosing sums from a penny stamp up to many shillings. This is the first radio auction sale that has come to our notice.

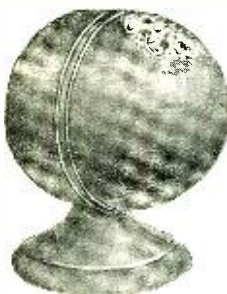

This English miniature loud speaker is advertised as being "no larger than a wine-glass." It is claimed by the makers that it is remarkably free from distortion. It is made of a substance resembling tortoise-shell, and is an ideal instrument for a portable set, since it can easily be carried about in the pocket.

Radio Guessing Competition

The other Sunday evening the B. B. C. station at Bournemouth conducted a contest entitled "Requests and Guessing," and offered a prize of about fifteen dollars to the listener who sent in the greatest number of correct answers to the following: The names of the singers; the names of the songs sung, together with the composers' names; the names of the instrumental solos with the names of the composers and instruments;

and the names of the selections played by the orchestra, together with the names of the composers. Such an event as this certainly tends to make radio fans brush up on their musical knowledge and history.

English Radio Vocabulary

When two English radio fans meet and discuss their receivers, the terms they use are very different from those employed by radio enthusiasts in this country. When one of them bewails the fact that his "accumulator" failed him the night before, he is speaking of his storage battery. If the battery is used for lighting the filaments of the "valves," as he refers to his vacuum tubes, he calls it a "low tension" accumulator, but if a "B" battery is under discussion it is called a "high tension accumulator." If dry cells are used they are called batteries.

Coils, instead of being wound on tubes, are wound on "formers." The variable taps on a "B" battery are called "vander plugs," giving one the impression of a sleep-walking connector. The plate of the tube is called the "anode" and their type of tube corresponding to our 201-A is a "dull emitter valve." They never ground a set, but "connect it to earth." Regeneration is referred to as "reaction" and a reflex circuit is a "dual amplifier," the audio frequency amplifying portion of it being named the "low frequency magnifier." Basket-weave coils are our good old spiderwebs.

Radio Conditions in England

The latest reports from England indicate that radio is increasing in popularity. It is estimated that there are about 1,400,000 licensed sets in operation, and if there are

four listeners in every home, as is assumed to be the case in this country, then there are approximately five and a half million listeners in Greater Britain alone.

Receipts from broadcasting licenses last year totaled approximately \$2,700,000, of which about 60 per cent. went to the British Broadcasting Company and the remainder to the Post Office Department. British fans are probably a bit more stable and constant than those on this side of the Atlantic, as they not only pay for their entertainment, but listen in regularly to get their money's worth. Over here, where we are all "dead heads," so to speak, we are inclined to be a trifle blasé when it comes to programs, unless they are above par.

Here is an English adaptation of the American "bird-cage" antenna. This antenna is placed in a vertical position on a pole, as shown. It may be adjusted to any desired height so that any amount of wire can be run between the two spreaders, which are formed of heavy wire with insulators on the ends, over which are wound the antenna wire.

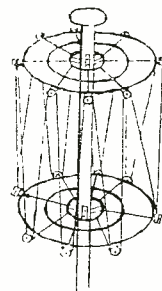

The British Broadcasting Company stands ready to build a second 10 kw. station in London, it is reported, although they already face a loss from the depreciation and obsolescence of their present transmitter, and anticipate a possible reduction in license fees, which would reduce their annual income. However, what was a sporting proposition to Great Britain a year or two ago seems to be developing into a paying public service.



GERMANY

Human Body used as Antenna

Using radio apparatus, with the human body as an antenna, a German physiologist, Dr. Lilienstein, has succeeded in hearing the action of the muscles.

German Receiving Stations

Inasmuch as all German stations are licensed by the Government, it is easy to know the number of receiving stations in the country. It should, however, be understood that a very large percentage of the German receivers are crystal sets. As a matter of fact, according to a German authority whom we interviewed recently, approximately 80 per cent. of all sets in Germany are of the crystal variety.

Below is a list of the largest cities, giving the authorized radio stations in each:

Berlin	264,531
Hamburg	100,042
Munich	78,119
Leipzig	56,233
Frankfurt a. M.	50,465
Breslau	43,098
Stuttgart	22,199
Münster i. W.	19,138
Königsberg i. Pr.	12,985



K. Inukai, Japanese Minister of Communications, with his family, listening in on Tokyo's first official radio program. © Wide World Photos.

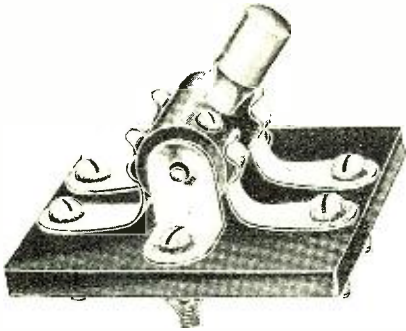

The English anti-capacity switch here illustrated is so simple that there is nothing to get out of order. It is a double-throw switch and may be obtained with either single or double poles. The phosphor-bronze contacts and the bakelite base make it electrically efficient.

Colored Head-Phones

The Germans with an eye to beauty are beginning to manufacture head-phones with ear-caps of strange and awful colors. The aesthetically inclined radio enthusiast may now choose different caps for each of his moods—baby blue for the bed-time stor-

ies, bright pink for soprano solos, and perhaps one striped with the national colors for patriotic occasions.



JAPAN

Powerful Government Radio Station

The Japanese Government has an item of 1,500,000 yen in its new budget for the construction of a 50-kw. station on the Island of Yap. This will be one of Japan's connecting links with the American continent and will be erected under the terms of the American-Yap-Japanese agreement.

RUSSIA

Uncle Ivan Succumbs to Radio

Radio is the latest thing to sweep Russia. The urban populace is gripped by the craze which is beginning now to spread to the rural districts. The demand for receiving sets far surpasses the supply. Six thousand workingmen's clubs and twelve thousand provincial reading-rooms are being equipped

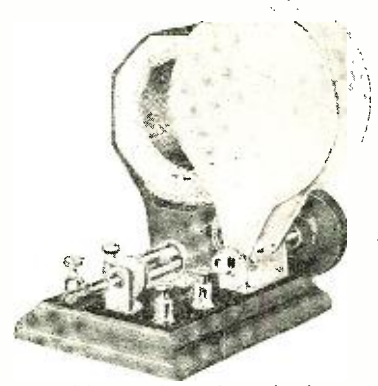

The English crystal set shown in the accompanying sketch is tuned without the use of condensers or tapping the inductances. The movable plates vary the magnetic field that is set up by the coil and so affect the wave-length of the receiver. It is called "eddy current tuning." Different coils may be plugged into the socket to receive stations of different wave-lengths.

with loud speakers. The principal types of broadcast programs are news items and concerts.

Esperanto Lessons

(Prepared Especially for RADIO NEWS by James Denson Saxers, Esperanto Writer and Editor, President New York Esperanto Harmonio Club.)

EXPRESSIONS OF TIME

Day before yesterday, **Antaŭhieraŭ**, Day after tomorrow, **Postmorgaŭ**, Sunday before last, **Dimonĉan antaŭ lastan**. The week after next, **La semajno post la venonta**.

The accusative is used in indicating a certain period of time if the preposition is not used: **Lastan fojon mi vidis al vi**, Last time I saw you. One could say: **Dum (or ĉe) lasta fojo mi vidis vin**, but it is awkward. **La venontan sabaton mi venos**, I shall come next Saturday, or, using the preposition, (**Dum or en**) **la venonta sabato mi venos**, but the accusative form is more euphonous.

SHOWING POSSESSION

Besides the pronominal possessives, **mia, via, nia**, etc., the general way of showing possession is by **de**: **La ĉapelo de la knabo**, The boy's hat; **La domo de la patro**, The father's house.

Possession is also shown by the correlative words ending in **ES**: **Ies**, someone's, somebody's; **ĉies**, everyone's, everybody's; **kies**, whose; **nenies**, nobody's; **ties**, that one's.

Examples: **Ĉu tiu estas ies hundo?** Is that anyone's dog? **Ĉies kapabloj estas diversaj**, Everybody's abilities are different. **Kies domo estas tiu?** Whose house is that? **Ci estas nenies**, It is no one's. **Ties koloro estas pli bela**, That one's color is more beautiful.

ELISION

Elision is not common in Esperanto, except in poetry. In poetry it is used both in **de l'** for **de la** and in dropping the final **O** of substantives. Many of the best prose writers of today elide the **a** in **la** when preceded by **de**, rendering it **de l'**. It is generally regarded as best to avoid elision. The following will illustrate the use of elision in **de la** and the final **O**:

Gis la bela sonĝo de l' homaro (de l' for de la).
Por eterna ben' efektiviĝos (ben' for beno).

Fill the beautiful dream of humanity. Shall be realized for an eternal blessing.

Del' is pronounced as one word, **del**. The tonic accent is not affected by elision of the final **O** in substantives: **Homar'**, **homaro**, would still retain the accent on the syllable **ar**.

In rare cases the **a** in **la** is elided where the article is preceded by other prepositions: **Pri l'** for **pri la**, about the.

In poetry the **a** of **la**, when not preceded by a preposition, may be elided before a word commencing with a vowel:

L' espero, l' obstino kaj la pacienco
Jen estas la signoj, per kies potenco.
Hope, tenacity, and patience
Here the signs by whose potency.

POR AND PRO

Some students don't quickly grasp the difference, nor the significance of each of these two words. **Pro** is used where we could say in English *because of, on account of*, and **por** is used where we could say in the *interest of, for the benefit of*. **Pro lia bonkoreco mi faris tion por li**. Because of his goodheartedness I did that for him (for the benefit of him).

CAPITAL LETTERS (GRANDAJ LITEROJ)

Use capital letters as in English, except:

For words derived from the names of places, as: **La angla nacio**, The English nation. **Li estas franco kaj loĝas en Francujo**. **Oni parolas la rusan lingvon en Rusujo**. One speaks the Russian language in Russia. Days of the week and names of the months are usually written in small letters, although Dr. Zamenhof capitalized names of the months. Pronoun for first person, **"I"**, **mi** always with small letter. Mr. and Mrs., **"Sinjoro"** and **"Sinjorino"** are written by some authors in small letters, but it is more complimentary to use capitals.

SYNTAX

The order of words in sentences in Esperanto is so similar to that of English that it does not require special treatment in a short course like this. A little reading of current Esperanto literature will show this. But if a German places his

verb at the end of the sentence, or a Spaniard follows his nouns with his adjectives, the direct form of Esperanto, with its valuable accusative **N** makes such national peculiarities clear to anyone. Adjectives are sometimes placed after their nouns in Esperanto for the sake of emphasis.

LESSON 10

COMMONLY USED ABBREVIATIONS

There are a few abbreviations quite frequently used in Esperanto. The following are the most common:

- Dro., Doktoro**, Doctor.
- F-ino, Fraŭlino**, Miss
- Pro., Profesoro**, Professor.
- Sro., Sinjoro**, Mr.
- Sino., Sinjorino**, Mrs.
- Ko., K-io, Kompanio**, Company.
- No., N-ro., numero**, No., number.
- & kaj**, &.
- Ĉ., ĉirkaŭ**, around, about.
- Sm., spesmilo**, (money unit).
- Sd., spesdeko**.
- ktp., k.t.p., kaj tiel plu.**, (and so forth).
- k. sim., kaj simila (j) et. sim.**
- t.e., tio estas, i. e.**
- e., ekzemple, e. g.**
- p.s., postkribajo, P.S.**

CORRESPONDENCE FORMS

The form of dating a letter is as follows:

Novjorko, Usono,
je la 31a de marto, 1925.

The foregoing is the full form according to rule, but common usage now in the large volume of international correspondence in Esperanto has begun to leave out the **"je"** and in its place uses the accusative, thus:

Novjorko, Usono,
la 31-an de marto, 1925, or just
31-an de marto, etc.

As it is customary in very few countries to write the names of week days and of months in capitals, it is best to follow that most general custom and not capitalize these words.

Responde je (or al) via letero de la 15a
In response to your letter of the 15th, etc.

(Continued on page 109)

The Hoyt Augmentor Circuit

By FRANCIS R. HOYT

This receiver is an interesting one for the experimenter, as it has several new features. The set shown was constructed in the RADIO NEWS Laboratories and gave excellent results.



IN presenting this new system of radio reception, it will probably be well first to set forth its general electrical characteristics from an operating point of view, and then proceed to point out its chief virtues, before entering into a discussion of the principles of operation.

Signal augmentation, as the name implies, is a system of radio frequency amplification or magnification in which the initial signal is augmented by a properly phased signal impulse of exactly similar character; this reinforcing impulse, however, has as its source a circuit which is entirely independent from that in which it ultimately comes to add its effect. The details of this action and reaction will be seen shortly, so for the moment suffice to say that the general electrical characteristics to the ear—or from an audible point of view—are somewhat similar to the well-known regeneration system. Although it will be obvious shortly that this apparent similarity ends with the audible characteristics, and that, unlike regeneration, the circuit does not radiate energy, cannot be made to distort a signal and is not subject to body capacity effects.

The distinguishing features of this new system might be set down in the following fashion:

1. Extreme selectivity
2. Sensitivity
3. Tone quality.

Whatever degree of popularity it has attained and is attaining can be attributed to these three qualifications.

THE FUNDAMENTAL CIRCUIT

The fundamental augmentation circuit shown in Fig. 5 bears a striking superficial resemblance to two familiar types of radio circuits. This resemblance has led to its being confused with those circuits by the casual observer.

First: The variable coupling between the

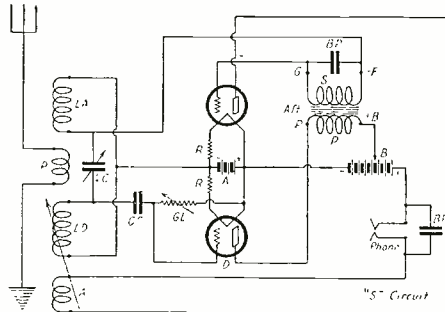

Fig. 1. The "S" circuit in which the tube functions as both an A.F. and R.F. amplifier.

"Booster" and the grid coil (designated LD on the diagram) bears an outward similarity to the tickler form of regeneration; second: the parallel disposition of the two tubes, one at either end of the secondary inductance, appears to approximate "push-pull" circuits. The following description of the operation of the augmentation system may be of some assistance in dispelling those illusions.

An incoming wave of radio frequency

energy passing through the primary coil (P) coupled to the secondaries LA and LD, would cause a corresponding voltage variation across the outside terminals of these secondaries which are connected to the grids of two tubes. This voltage would be of opposite polarity or phase at opposite ends of the coils. Consequently, the grid of one of these tubes would receive a positive charge, while the other would be acted upon by a negative impulse. Now, one of these tubes is connected as an amplifier and the other as a detector (having a grid condenser in its grid circuit), therefore, when the amplifying tube is acting to magnify the positive impulse the detector tube is simultaneously rectifying or detecting the accompanying negative flow. Here the "Booster" coil comes into play, the magnified energy of the positive charge appearing in the plate circuit of the amplifying tube passes through the booster coil, where it is placed in the proper phase to lend its additive effect or augment the negative impulse at that moment being detected. The degree of this augmentation is regulated by the percentage of coupling.

THE "S" CIRCUIT

The feeble radio frequency currents traveling through the augmentation or amplifying tube do not begin to load this tube to even a small degree of its amplification possibilities. It was, therefore, a logical conclusion that the tube should be so connected in the circuit that it could perform additional duty.

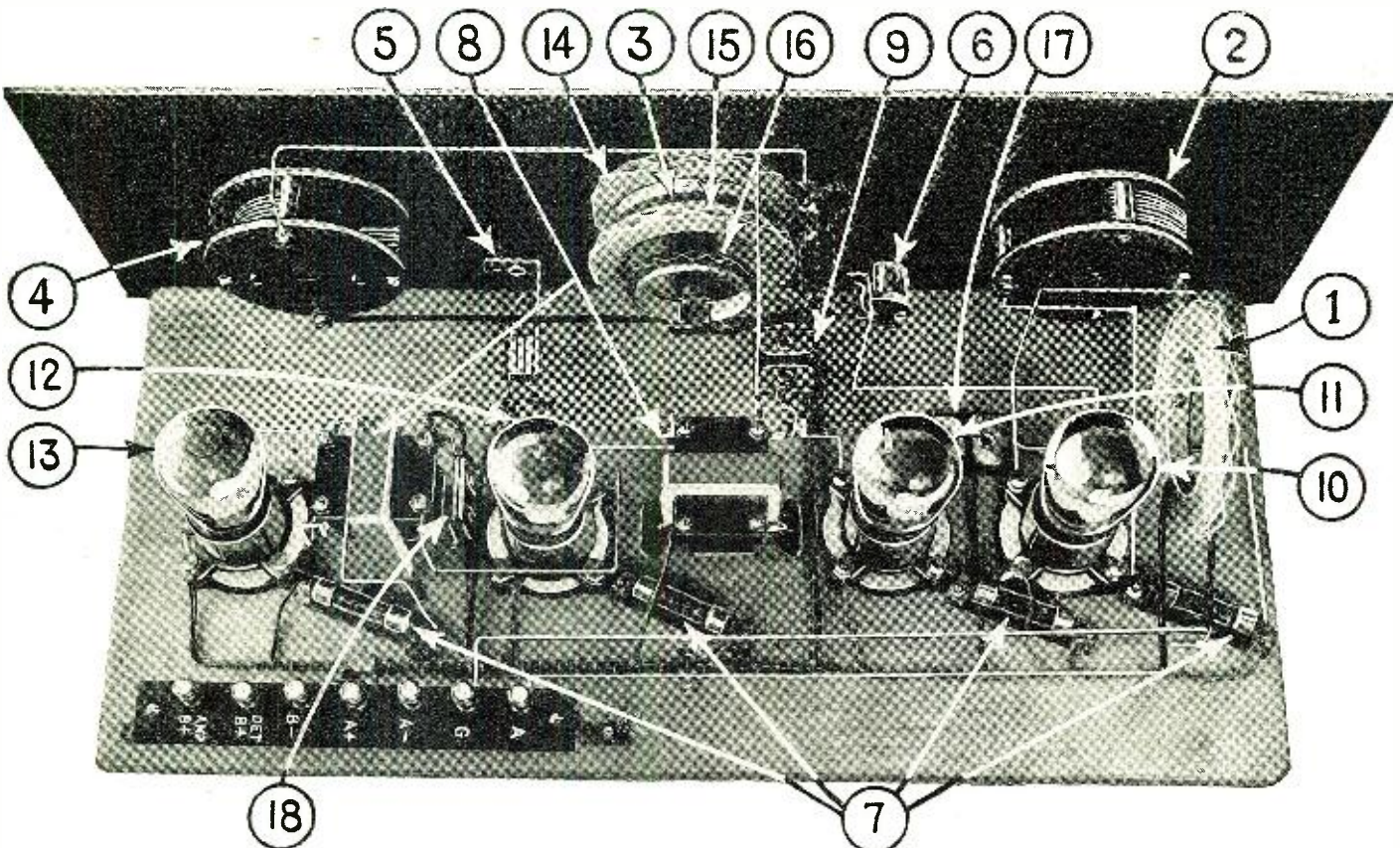

Fig. 2. Rear view of receiver. 1, antenna coil; 2 and 4, variable condensers; 3, primary coil; 5, phone jack; 6, filament switch; 7, amperites; 8, A.F. transformers; 9, grid condenser; 10, R.F. tube; 11, detector tube; 12, augmentor tube; 13, A.F. tube; 14, detector inductance; 15, augmentor inductance; 16, augmentation coil; 17 and 18, by-pass condensers.

By the circuit combination shown in the diagram, Fig. 1, the augmentation tube is made to function both as a radio and as an audio frequency amplifier. This may be called a reflex arrangement, although the performance characteristics are somewhat different.

After the signal has been detected in the detector tube and changed from a radio to an audio frequency impulse, it is communicated to the primary of an audio frequency transformer whose secondary has been connected in series with the grid lead of the augmentator tube. In this way, audio frequency voltage variations taking place in the primary of the transformer are transferred to the grid of the tube after having been magnified or "stepped-up" by the transformer. Upon reaching the grid of the augmentation tube these voltages cause an increased current to flow in the plate circuit and this is accompanied by an increased response in the phones.

A small condenser is connected across the terminals of the secondary of the transformer to permit the incoming radio frequency currents to reach the grid of the tube. These currents would otherwise be retarded by the choking effect of the secondary winding.

APPARATUS AND VALUES

In the diagrams referred to in the preceding paragraphs, the various pieces of apparatus have been designated by symbols and no values have been shown. These values will be given later or will be found on the wiring diagram for the four-tube receiver—the symbols used are herewith explained:

- LA—Augmentor inductance
- P—Primary
- LD—Detector inductance
- A—Augmentation coil

The above four windings make up the augmentor coil.



Panel view of Augmentor receiver.

- VC—Variable condenser
- A—Augmentor tube
- D—Detector tube
- R—Amperites
- GC—Grid condenser
- GL—Grid leak
- BP—Bypass condenser
- AFT—Audio transformer

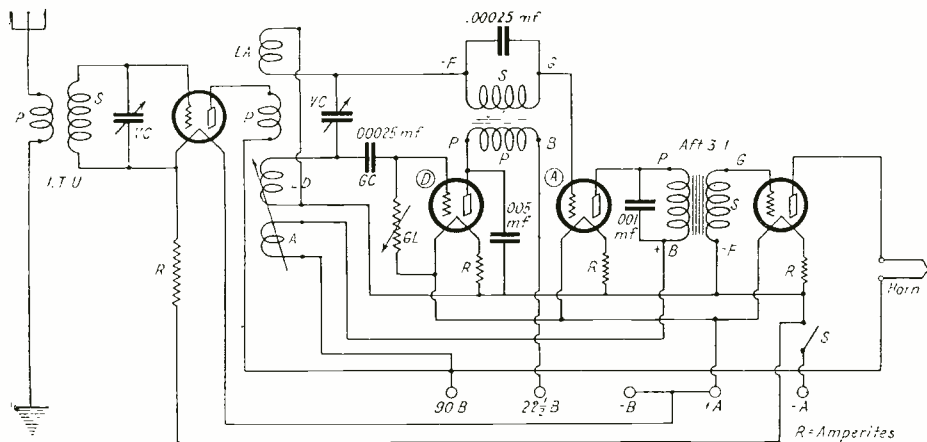
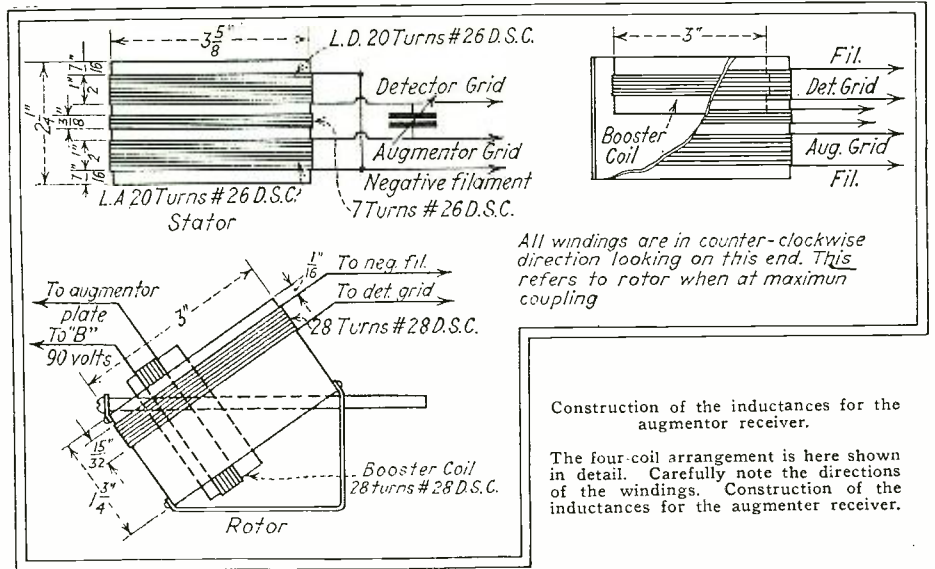

Fig. 3. Circuit diagram of the Augmentor receiver. D is the detector tube and A the augmentor tube.



All windings are in counter-clockwise direction looking on this end. This refers to rotor when at maximum coupling

Construction of the inductances for the augmentor receiver.

The four-coil arrangement is here shown in detail. Carefully note the directions of the windings. Construction of the inductances for the augmentor receiver.

The values for all of the various pieces of apparatus except the grid leak (variable), which should be from 1 to 6 megohms; the variable condensers, which are of .0003 mfd. capacity, and the coils, which will be given later, have been shown on the schematic diagram of the four-tube set.

It is important that the bypass condenser in the semi-reflex stage be of reasonably accurate capacity, .00025 mfd., and it is also necessary that a variable grid leak of reliable make be employed.

Since the Augmentor circuit is exceptionally stable, particularly in the matter of filament control, it is considered that better operation is secured through automatic filament control devices, such as the amperite, than by manual control or rheostats.

Straight-line wave-length condensers should by all means be given preference, and vernier attachment or vernier dials will be found necessary.

CIRCUIT WIRING

The augmentation system can be built up into receivers comprising any number of tubes from two to the practical limit, or, in other words, it is a principle of operation or fundamental circuit to which radio frequency and audio frequency amplification can be added at will.

The schematic wiring diagram for a four-tube set is shown in the illustration, Fig. 3, and a rear view photograph of a five-tube receiver of this type is shown in Fig. 2. This receiver is exactly the same as the four-tube, except that one additional audio frequency stage has been added.

This rear view photograph, Fig. 2, also serves to illustrate the preferred arrange-

ment of the physical apparatus, the relation of the augmentor coil to the condensers and indicates how admirably this receiver lends itself to cable or "harness" wiring.

COIL CONSTRUCTION

Fig. 4 is an illustration of an augmentor coil which has been designed around standard sizes of tubing and of simple solenoid winding with the object in view of affording a construction which can be made up in the

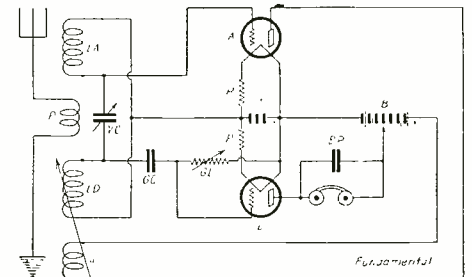

The circuit that shows the fundamental principle of this interesting receiver.

home. While the low-loss coils manufactured expressly for this circuit are quite naturally to be preferred, nevertheless, there are those experimenters who prefer to construct their own coils and to those who carefully follow the data given, a very satisfactory set of coils can be constructed from these specifications.

The rotor consists of a 1 1/4-inch length of 3-inch outside diameter bakelite tube, while the stator is a 2 1/4-inch length of 3 5/8-inch bakelite tube.

The augmentor coil is wound on the rotor and is made by winding 28 turns of No. 28 D.S.C., beginning the winding 1/8-inch from the edge.

The LD or detector inductance is first wound on the stator, beginning 1/8-inch from the edge and consists of 20 turns of No. 26 D.S.C wire. A space of 3/8-inch is then allowed and the LA or augmentor inductance is completed by winding 20 additional turns of No. 26 D.S.C. wire.

The P or primary winding is wound in the center of the 3/8-inch space above referred to and consists of 7 turns of No. 26 D.S.C. wire.

The direction of the turns of the windings is shown in the illustration, Fig. 4, as well as the proper terminal connections.

When the rotor is assembled in the stator, it should (at maximum coupling) mount so that it will be midway of the stator, or in other words, 1/4-inch on either side below the outside edge of the stator tube. This is shown in the drawing.

Single Control

By SIDNEY E. FINKELSTEIN, A.M.I.R.E.

This is the first of a series of articles by Mr. Finkelstein in which he will make a comprehensive discussion of the single-control problem. He will deal with the subject from all angles.



IT seems that everything must go through certain well-outlined stages of development, beginning with the complex and ending with the simple. As we look back over the years we may remember our forebears with their multitudinous frills and furbelows; as we look back we can remember our ancient radio sets looking like a half-dozen safe-fronts all cast into one.

We have now reached the age of simplicity, in many things as well as in radio. It is the style now to have only a single dial on the receiver's façade, which is a good thing for the female folks at home, who never could understand how to "twiddle those knobs."

The present article shows some of the many ways in which the single-control idea can be incorporated into the radio receiver. Some of them are relatively simple, both in principle and construction, so that it may interest many of our readers to try out some of these methods. —EDITOR.

THE last few years have witnessed such tremendous strides in the progress of radio development, with the tendency toward single control receivers steadily growing, that it is the purpose of this article to give a complete resumé of all the various methods employed by manufacturers of radio apparatus, and experimenters to use unicontrol in their sets. Further, it is the object of the author to introduce new and original methods of obtaining single control and enumerate those methods which have already proved themselves favorable in the eyes of the experimenter.

In the following article, the different mechanical arrangements for obtaining this objective, will be discussed.

One of the most common methods employed at present is the gearing arrange-

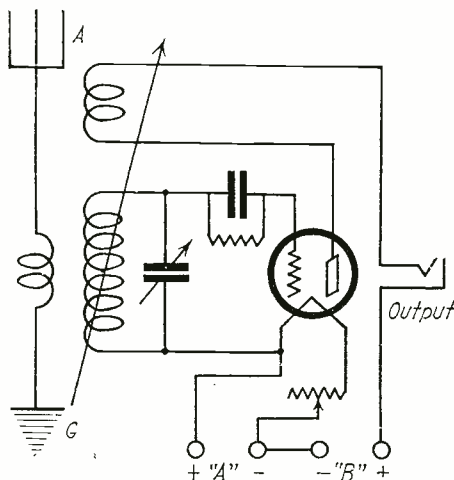

Three-circuit tuner diagram. This is one of the most difficult circuits to put under single control.

ment. Fig. 1 illustrates how as many as five separate variable condensers may be controlled by a single knob or dial. One can readily see that a rack gear in mesh with a small controlling gear will simultaneously move all the rotors of the condensers. By experiment, each condenser can be set at a different point, so that no further adjustment need be made and that each circuit will be in resonance. This method is employed by several manufacturers, but a common defect of this lies in the back-lash, or lost motion in the gearing, which prevents accurate tuning and results in the inability of the receiver to stay constant at a given wavelength reading. This fault may be overcome to some extent by putting what is known as a "drag" on the main pinion. This may take the form of a phosphor bronze spring which exerts pressure against the side of the pinion and prevents the detrimental back-lash.

selection of a spring having the right tension, such as can be purchased in the "five and ten," by calling for a door spring, is essential for best results. This method is highly recommended to the beginner.

In due course of time, the cat-gut or spring will loosen up on the pulleys and instead of tuning both condensers simultaneously in step, will rotate one slightly

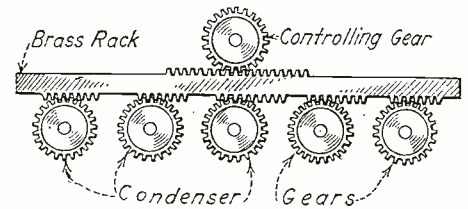

Fig. 1. As many as five condensers may be controlled by a single knob.

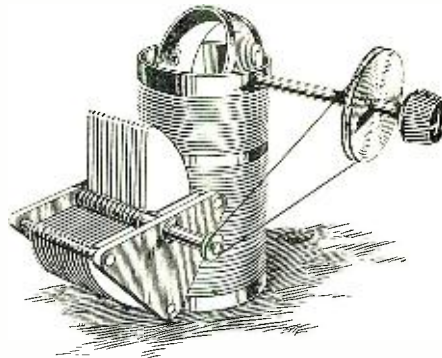

Fig. 7. Approximate relative sizes of pulleys for condenser and coupler rotor.

Fig. 2 shows the way in which this is accomplished.

The gear rack may be of metal, generally brass, while the gear wheels can be made of an insulating material, such as formica, fibre, etc. Careful matching of all inductances and capacities is absolutely essential to the successful operation of a receiver in which this method of unicontrol is used. The above system may be employed where two or more stages of tuned radio frequency amplification are to be used.

Refer to Fig. 3, which shows a circuit using four stages of tuned R.F.

The second successful method of using a single control, is to incorporate several variable condensers which are actuated by a system of cords and pulleys such as shown in Fig. 4. Either cat-gut or a coiled spring may be used to advantage. An outstanding feature of this method is that when the controlling pulley is made very small and the pulleys on the condensers large, very fine vernier control can be achieved. Again, the back-lash is not difficult to overcome. It is also possible to readjust each condenser if found necessary, very exactly, and so check upon the resonance. Moisture will affect the cat-gut, whereas the coiled spring will last indefinitely. Fig. 5 shows one type of receiver to which this method is well adapted, being one stage tuned radio frequency, non-regenerative detector and a push-pull amplifier. It must be borne in mind that the

more than the other. In such an event, the following method of remedy is prescribed. Where the shafts and the fastening screws of the condensers go through the panel, it will only be necessary to make these holes elliptical so as to enable the condenser to be moved and in this manner, be able to take up the play. Note Fig. 6 which shows how this should be done.

One of the most popular receiving sets is the familiar three-circuit, regenerative set, so called because it employs three separate and distinct parts. The antenna circuit, the secondary or grid circuit wherein is accomplished extremely fine tuning, and a tickler feed-back plate circuit, constitute the components of this well-known set.

Just why this receiver is so popular, and then again of late becoming the object of severe censure, is explained in the following paragraphs.

It is known that an inductively coupled set will tune more sharply and be more selective than one which is conductively coupled. This quality is highly desirable and is attained by employing two coils in inductive relation to each other. One coil which can

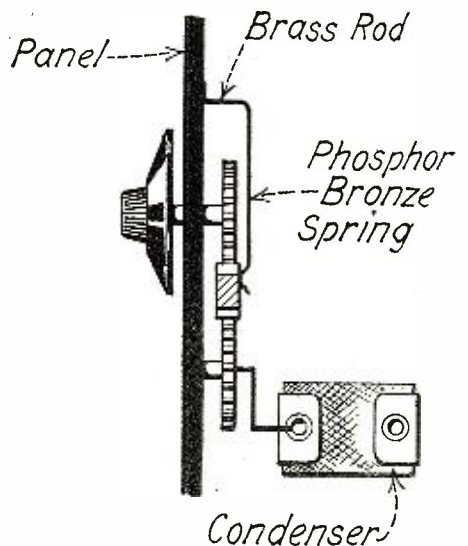

Fig. 2. Method of arranging gears for single-control system.

consist of a few turns of wire (10 or 12 will do), is called the primary coil and is connected in series with the antenna and ground. This antenna system is termed semi-aperiodic, that is, individually it is tuned to but one wave-length, its own fundamental resonant period of vibration. This may be anywhere from 100 to 600 meters for broadcast reception, depending of course, upon its length and height. However it will also respond to other waves of different lengths, and, as usual, a magnetic field will be set up around the primary coil which will consist of the wave-lengths of a great number of stations. The secondary circuit is now relied upon to pick out the desired frequency. Thus we turn the variable condenser and tune in the particular station we want.

This variable condenser is placed across this secondary coil and the combination forms the tuned circuit. When this circuit is adjusted to the desired wave-length, the detector tube will, if the other necessary conditions are correct, rectify the radio frequency impulses and the result will be reproduction of the original sound in the phones. The signal is fairly strong if from a local station, but it can be greatly amplified, not by means of an additional audio frequency amplifier, but by the introduction of regeneration into the detector circuit.

By regeneration is meant the feeding back of the signal, from the output of the detector tube, to its input. This can be done in two ways, by inductive or by capacitive feed-back. Of the two, the inductive method, which, by the way, was first discovered, is the more commonly used and is used in the three-circuit tuner. If a third coil of wire, generally having nearly as many turns as the secondary, is placed in proximity to the secondary, and arrangement made so that its coupling or inductive relation to the secondary may be varied, it is possible to obtain much greater volume, procure sharper tuning and high degree selectivity.

It is well known that in employing this circuit, it is necessary to adjust the coupling between tickler and secondary as we change the wave-length of the secondary circuit. This results in the need for another control. Of itself this is not objectionable, but we can go a step further and incorporate this

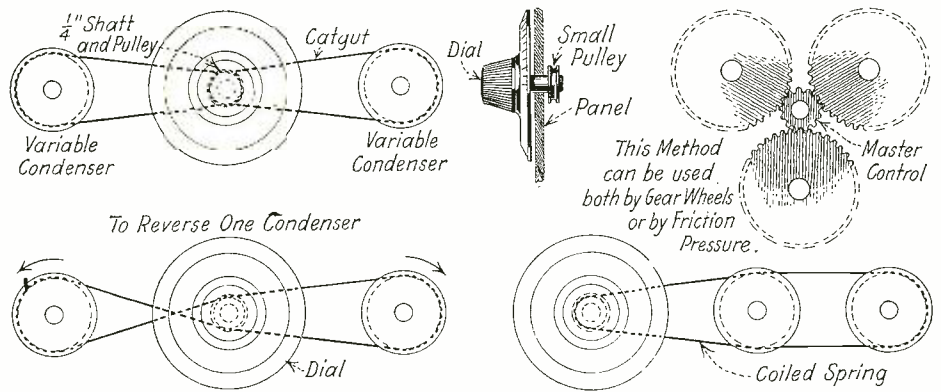

Fig. 4. Different methods of gearing the three condensers to one control.

extra dial together with the condenser dial which is used to tune the secondary, providing the exact relations required between settings of the two dials are known. Any one of the several methods shown may be used, but it is preferable to use the one depicted in Fig. 7.

This method consists of a pulley arrangement between the condenser and the tickler coil of the tuner. As stated previously, the only objection to the regenerative type of

sorts of squeals and howls in its immediate neighborhood.

To properly control the regeneration so that the set does not oscillate, the pulley system is adjusted so that the tickler is rotated about 1/15th as fast as the tuning condenser. Of course, the tickler coil must be set at a point just before the set starts to oscillate. It is rarely necessary to readjust this after the first adjustment is made properly.

This mechanical safeguard against radiation is in itself quite commendable, not only on account of its extreme simplicity of construction, but on account of its effectiveness in preventing undesirable oscillation.

Regeneration is the greatest discovery that has been made since DeForest's invention of the vacuum tube. Without it, no set can be called a good one, for there is no other medium which can give such excellent results. Even tuned neutralized radio frequency amplification without the least bit of inductive or capacitive feed-back or regeneration is, as a matter of fact, far inferior to the old standby three circuit tuner.

The above statement is made only after the author undertook an exhaustive series of tests which have proved conclusively beyond the shadow of a doubt, that th regenerative qualities must be retained in all types of sets if maximum results are to be obtained.

But there have been several drawbacks which have prevented manufacturer from arriving at the desired goal. First, the introduction of regeneration gave rise to the inevitable occurrence of oscillations of an audible nature, which we are well acquainted with, as the cause for the howling and squealing in our set. Secondly, regeneration necessitated the introduction of added controls which complicated the tuning operations for the beginner.

On account of the difficulties attending self-oscillation, many have sought to suppress the regenerative receiver. Tuned radio frequency and then the neutralized receivers took their place on the market. Some of them regenerate nicely, others very poorly, causing their owners no end of trouble. Some are unstable in operation while others squeal miserably and spoil the entertaining value for which the receiver is purchased. But the main consideration is this: practically all of them have a number of controls which add to the difficulty of the inexperienced layman when he attempts to listen-in for the first few times.

Single control is the inevitable outcome of the receiver of the future. Hereafter, not only dad, but mother, brother and even baby sister will be able to tune in without the slightest trouble. And not only will the music come in clearly and loudly, but it will be steady and pleasing to the ear.

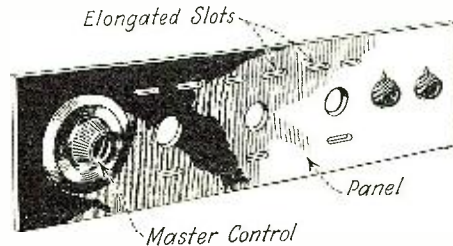

Fig. 6. The slots in the panel allow for the adjustment of the instruments.

receiver is that it is a powerful radiator if it is not properly handled. Your neighbors may have inquired whether you own such a type of set, and you may have, unconsciously, proudly boasted that you had. And they may have politely asked you to sell it or give it away or even junk it! No wonder, when such a set is responsible for all

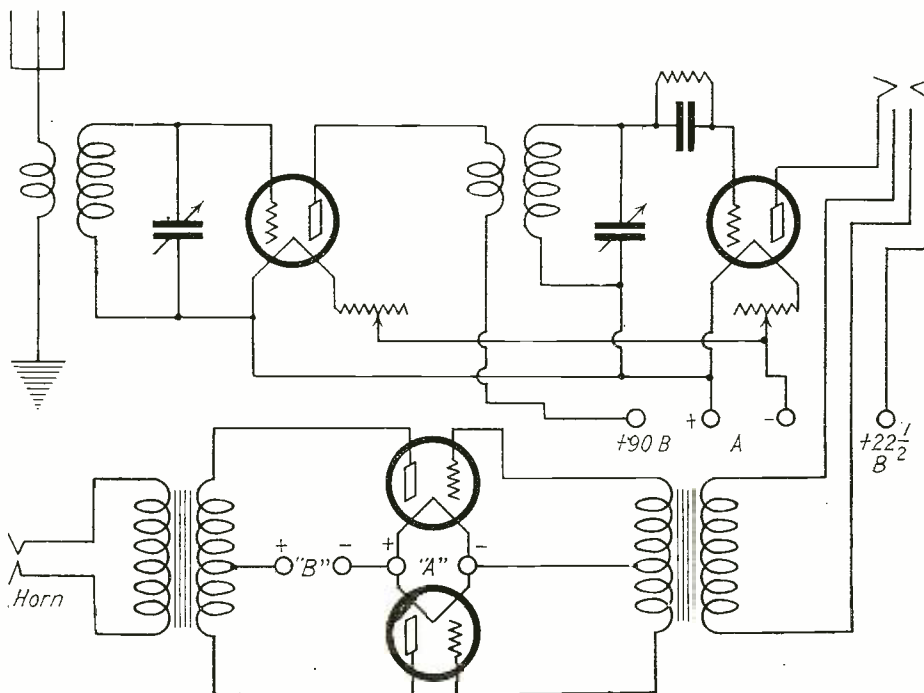

Fig. 5. Four-tube circuit, comprising a stage of tuned radio frequency amplification, detector and one stage push-pull amplification.

Needed Radio Inventions

By JAY HOLLANDER

The discussion below tells what is immediately necessary in radio invention.

IF radio is to become as stable a form of entertainment as the talking machine, the reproducing piano, vaudeville, the theatre and the banquet with speakers—all of which it is partially at the present time—it must have several improvements in the next few years to make it available to everyone.

There will be immediate cries from all and sundry at this statement. Each will point with pride and call attention to his own pet set and say that the four- or five-year-old daughter tunes in the Jungle Harmonizers every night to put herself to sleep with.

This may be true and then again it may not—most usually is not, for the fact remains that with the present-day sets there are few which can be installed and then turned on and off like the electric lights or the water in the bath tub. In order to reach this state of affairs, several new adaptations

laughable, but so also did many other of the present designs when they were first suggested. It should be a simple matter to make a tube with a double set of grids and a double set of plates, with each of the grids connected to the opposite end of an inductance, and the filament return taken from the center. Then one of the plates could be attached to one side of the line and the other to the opposite side. A heavy choke could be inserted in both sides of the circuit with condensers across it. Then a large resistance could be placed entirely across the line, as shown in Fig. 1, and connections completed as shown. This circuit would, in all probability, not work in its present form—the engineers and designers with facilities for the experimenting necessary would have to make it workable. Theoretically, however, it would function.

The filament could be changed into any form compatible with the prices of the manufacturer.

This idea is given merely as an illustration of the trend of design. The set must be so simple that the necessary changes of tubes will be as simple in the radio set as changing light globes is now in the lighting system.

And this brings up another point: Not only must the change be made as simply as possible, but it must interfere in no way with the efficiency of the set's operation. In other words, the set must be so designed that the characteristics of the tubes will make no difference in the net operation of the apparatus they are employed with. It is well known that the super-heterodyne's intermediate stages depend to a great extent for their efficiency upon matching the plate impedances of the various tubes—or rather the over-all impedance of the collective plate circuits.

Just what will be necessary along this line the writer is not prepared to state. However, he believes with the old adage that a clear statement of the problem at hand is half the solution.

SINGLE CONTROL A NECESSITY

And this calls for another observation with a practical hint. Radio sets must be made to operate with a single control. Already there is a great cry in the industry for this and, indeed, several sets on the market making broad claims to this feature. But in most of them efficiency is lost. That is, good engineering principle is forfeited in many cases for the sake of the single-control feature. This is not only bad economics but does not work for the advancement of the art. The problem is not to make a set operative with only one control, but to make it workable at its greatest possible electrical efficiency and to be controlled by one adjustment. (Here again, the idea of the plain statement of the problem being the largest part of its solution.)

Regeneration is gradually falling out of favor in the larger sets because it requires an added control, which in most cases is extremely difficult for the novice to handle.

Most engineers are agreed that the feedback from the plate in the grid circuit is dependent, pretty much, upon the frequency of the received signal. If, therefore, the set is so designed that the movement of the condenser tuning the grid circuit is proportional to the frequency, *i. e.*, if a *straight-line frequency condenser* is employed in the tuning, the regeneration may be handled from the same control as the tuning.

REGENERATION AND TUNING ON ONE CONTROL

This can be done something after the manner of the set described a few months ago in RADIO NEWS. The circuit employed is the Reinartz type, in which the plate feedback is of the capacity type, shown in the sketch at Fig. 2.

The amount of capacity needed is found by experiment and an extra set of plates attached to the back of the original tuning condenser. If fewer plates are necessary, so be it. They may be employed without trouble.

If the above plan does not work out satisfactorily, it should be entirely possible for a special plate design to be made, so that the change in capacity could be cared for automatically.

As to tickler feed-back, a point brought out in a set which was put on the market about eighteen months ago and then disappeared from the public ken might be used. This set employed the usual tickler construction, except that the turns on each side of the ball form, upon which it was wound, were different and of opposite polarities. By this means the peak of regeneration was spread over a great distance, some twenty degrees, if memory is correct, whereas in the ordinary set of the usual design it covers only about five. It should be entirely possible so to re-design such a piece of apparatus that the relation of rotation of tickler to rotation of tuning condenser would have a ratio which could be used to advantage in solving the problem of single control.

This same problem is evident in all the

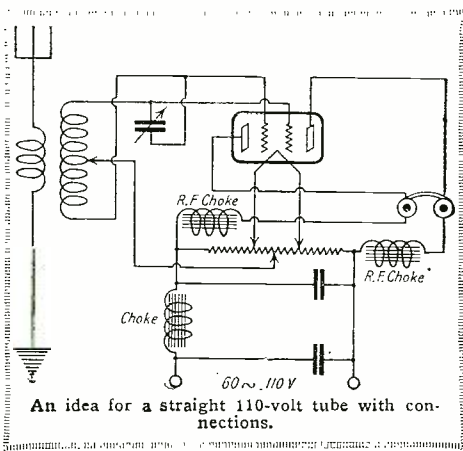

of present principles or some entirely new inventions are needed. The radio set of the very near future must be so designed and built that one may call up his nearest radio shop, tell the clerk answering the phone that he wishes a radio set of such-and-such abilities, stating whether he wishes loud speaker or phones for reproduction, and answering such questions as to the nature of the lighting current in his home and other matters concerning the location of the set as the clerk may ask.

Then—we are still in the *near* future—a couple of days following, an installer will knock at the door, come into the living-room, set his kit on the recently polished table, take out a cabinet from its crating, fiddle a while with bits of wire and such, and after a few minutes he will snap a switch, turn and ask you what station you would like to hear, move an arm or dial with an indicator and, behold!—the desired station comes in like the proverbial ton of brick.

WHAT IMPROVEMENTS ARE NEEDED?

But the interesting question at present is: What must be done in the way of design and new apparatus for this touted millenium to take place?

One of the first is, of course, a properly designed vacuum tube with its plate and filament current taken from the house lighting mains. Already much has been done along this line, but it seems that each engineer is working on his own little problem. There has been no attempt as yet to design a tube, complete in itself, to operate directly on alternating current. At first this seems

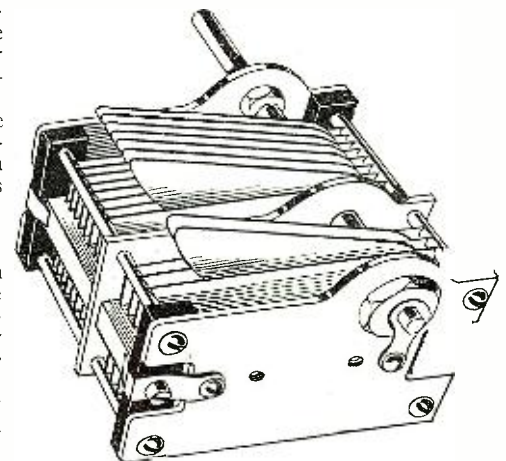

A straight-line frequency condenser on the order of the above will, more than likely, become of extreme importance.

sets employing tuned radio frequency. Some arrangement must be reached whereby the condensers can be so arranged that they will be exactly proportional throughout the whole circumference. This will do away with the present-day necessity for tuning each of the stages separately. It is already done in some sets, but in all those on the market at the present time each stage has a vernier control of its own.

MECHANICAL ASPECT OF THE PROBLEMS

And here the problem is one combining the mechanical with the electrical. Some little gadget will, no doubt be made in the future, which will enable the manufacturer to balance his condensers when building them. At the present time, however, this is not

(Continued on page 121)

A Non-Radiating R.F. Receiver

By the LABORATORY STAFF of RADIO NEWS

The second non-radiating receiver developed by the RADIO NEWS Laboratories. Feed-back is employed to prevent oscillation in the circuit.



IN the May issue of RADIO NEWS, a new circuit was presented to our readers, which was called the Monophase circuit. This circuit employed the principle of negative feed-back to stabilize the system and to prevent self-oscillation. It is an efficient receiver, as it can be constructed very readily without using extra resistance to prevent it from oscillating. Once it is adjusted, as near the point of oscillation as possible on the short wave-lengths, it will not squeal at any wave-length within its range.

We have, in this circuit, and the one to be described in this article, two exactly opposite types of radio frequency amplifiers which will not squeal. The first—the Monophase—is constructed with a large number of turns on the primaries of the tuned R.F. transformers, and the stabilizing is done by negative feed-back. In the circuit of this article there are comparatively few turns on the transformer primaries; this renders the circuit inherently inefficient. But in this case *positive* feed-back is employed, and, by this agency, the efficiency of the system made equal to that of the Monophase.

When positive feed-back is employed, however, there is always more or less likelihood of howling, as small changes in the adjustments of the circuits will upset the balance. For this reason, there is added to the circuit in one stage an absorbing coil; the feed-back coil is in the other stage.

The general arrangement is shown in the wiring diagram in Fig. 1. There is nothing out of the ordinary in the general arrangement of the circuits, with the exception of the coils A and B. The coil A is the feed-back coil and the coil B is the absorbing coil. The latter consists of three turns of wire wound on a short tube and short-circuited. The two coils are fastened on the same shaft, so that the adjustment is made simultaneously. The absorbing coil is so fastened to the shaft that it

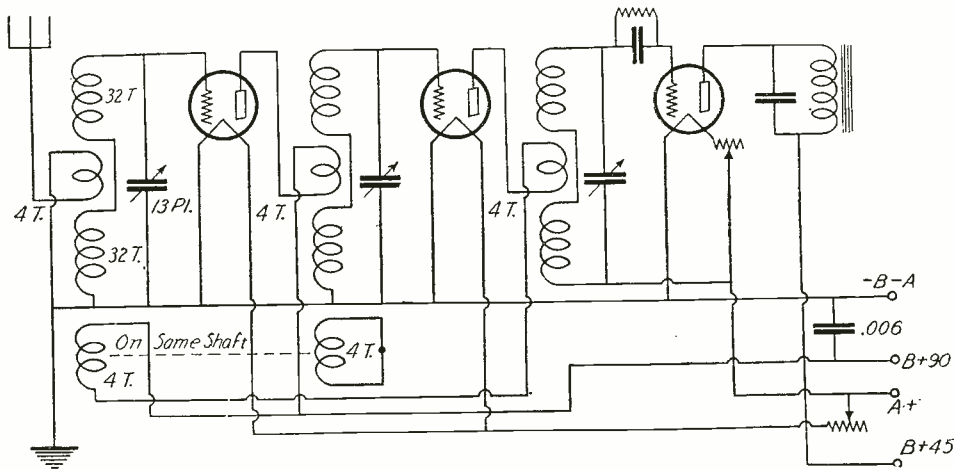

Fig. 1. Circuit diagram of the two stages of radio frequency amplification and detector. The audio frequency amplifiers are connected in the conventional manner.

can be set at any position on the shaft with reference with the other coil.
The method of adjusting the coils is as follows: Holding the absorbing coil B at right angles to the transformer coils, marked

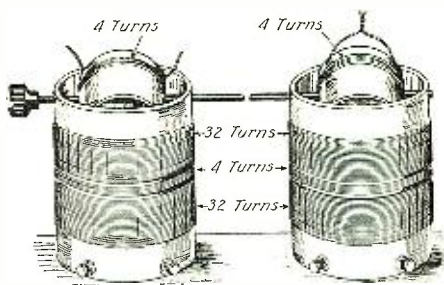
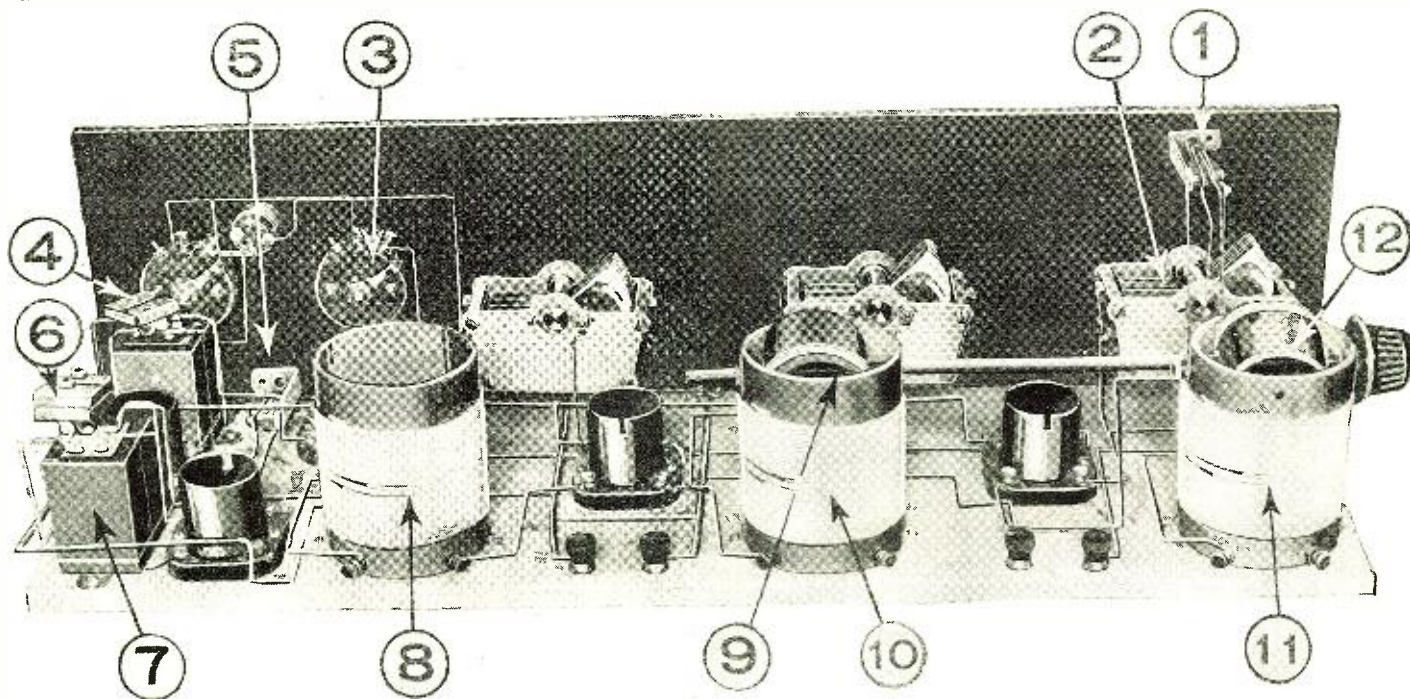

Fig. 2. Two of the radio frequency transformers' constructional diagram, both rotors being mounted on the same shaft.

C on Fig. 1, the shaft is turned, coil A turning at the same time, until the set begins to howl. This is done while receiving signals from a long wave station. Holding the feed-back coil A (which is fastened rigidly to the shaft) so that it cannot move, gradually turn coil B until the howling disappears. Once this adjustment is made properly, the set will not howl on any wave-length, and the efficiency at all times will be very high.

It is possible so to adjust the two coils with respect to each other that the pair can be rotated together, by means of the shaft, into the position giving maximum response from the receiver. The advantage of this method of stabilizing is that the absorbing coil, being composed of so few turns, can be adjusted very accurately. For this reason the set continually operates very close to the critical point; that is, to the point

(Continued on page 100)



Complete set: 1, antenna jack; 2, tuning condenser; 3, rheostat; 4, by-pass condenser; 5, telephone jack; 6, by-pass condensers; 7, audio frequency transformer; 8, detector inductance; 9, feed-back coil; 10 and 11, R.F. coils.

Activities of the Radio News Laboratories

By the Director

This article is the first of a series telling about the Radio News Laboratories.

AS our readers are probably aware, there is a multitude of apparatus continually coming into the RADIO NEWS Laboratories for test. This apparatus is submitted by the various manufacturers for the purpose of enabling RADIO NEWS to assure its readers through its LABORATORY columns that the article is worth using. In the past, there has been a great deal of apparatus put on the market by unscrupulous manufacturers who are not primarily interested in the performance of their products. As a consequence, radio fans have unwittingly spent a considerable amount of money in buying worthless material.

It was with a realization of this situation that the Laboratory columns were started—to safeguard the radio fan from the danger of buying this material. The purpose of these columns is not to specify which make of condenser is better than another, or which transformer is to be preferred to another, but is mainly to let our readers know that if they buy the instruments listed, they will not be "stuck." They can buy this apparatus with all confidence that it will work, that it is well constructed and enduring. RADIO NEWS Laboratories knows that there is no ideal apparatus possible, and that the problems of the manufacturers have to be considered, as well as the needs of the radio fans, in judging apparatus. Therefore, it would not be right for any testing laboratory to specify the details and construction desired in any piece of apparatus. Manufacturers of condensers, for instance, disagree with one another on matters of construction, the condensers of each maker differing considerably from those of the others in details of design, but hardly at all in electrical operation. For this reason it would not be proper to reject many of these, simply because the particular shape of end plate is not to our liking, providing, of course, the condenser operates satisfactorily and is well constructed. The reader should always bear these thoughts in mind when glancing over the Laboratory columns.

OF GENERAL INTEREST

On account of all this, it has been thought that it might interest our readers to know what is going on in the Laboratories, what some of the various tests are, how they are made, and what else is being done there. For this reason we are starting a series of articles under the above title.

Among the great amount of apparatus which has come in, there have been many electron tubes submitted by many different manufacturers. Some of these tubes will be

reviewed in the Laboratory columns of the next issue of RADIO NEWS. The characteristic curves of all these tubes are taken and kept on record in the Laboratories. These curves are not published, however, for they would mean little to the average radio fan. He can, very likely, obtain them by writing to the manufacturer of the tube.

APPARATUS

The general arrangement of apparatus used in obtaining the curves is as shown in Fig. 1. The photo of the apparatus is also shown. To measure the plate current-grid voltage characteristic, all that is necessary is to place a known voltage between the grid and filament of the tube, which forms the input side, and measure the current flowing in the plate-filament circuit under the known voltage. Using constant voltages, as from batteries, this method gives what is known as the "static" characteristic, as distinguished from the "dynamic" characteristic, which is obtained in actual practice and is the characteristic which would be obtained if alternating voltages were impressed on the input side of the tube. This will be explained at some future time in these columns. The static characteristic, however, furnishes enough information from which the remain-

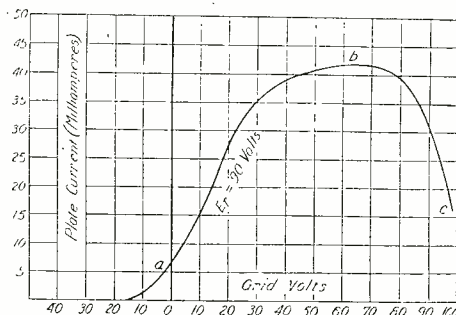

Fig. 2. "Static" characteristic curve of an electron tube, as obtained in the Radio News Laboratories.

ing constants of the tubes may be obtained and at the same time acts as a guide toward the proper operation of the tube.

In Fig. 1, the voltage for the input of the tube is furnished by means of the battery at the left marked E1. This battery is connected to the potentiometer and the voltage to be applied on the grid, marked eg, is taken from one end of the potentiometer and slider. This is passed through a D.P.D.T. switch, arranged to reverse the polarity if necessary. The voltmeter marked Vg measures this in-

put voltage. The constant voltage applied to the plate of the tube is furnished at E2, having the polarity as shown. An exceedingly accurate direct current ammeter is connected in the plate circuit to measure the plate current. At the same time a voltmeter marked Vp, is connected across the potentiometer so that the plate voltage may be checked and kept constant.

When these tests are made, it is necessary that the tube be kept constantly in operation

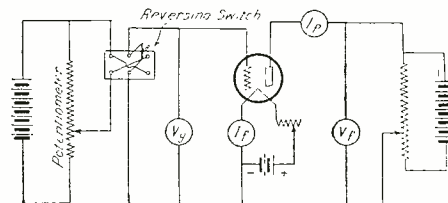

FIG 1
Circuit for testing electron tubes, showing positions of meters.

under the conditions for which it was manufactured. The plate voltage must agree with the manufacturer's rating and, likewise, the current through the filament. The latter is checked by the ammeter marked If.

PLOTTING CURVES

In plotting the characteristic curve, the first point to obtain is that which shows zero current in the plate circuit. This is the lowest point of the curve and the most difficult to find. It is difficult for the reason that the curve becomes horizontal at the lower end, and large variations in the negative voltage impressed on the grid produce imperceptible changes in the plate current. Hence, when the switch is thrown so as to make the grid negative, the slider of the potentiometer may be moved down quite a distance without producing any change in the reading of the ammeter Ip. In the RADIO NEWS Laboratories, a microammeter is used in the plate circuit to obtain the lower part of the curve, so that this part is generally obtained with a precision far in excess of what is needed. Readings of the plate current are obtained for various values of the grid voltage, all the time keeping the filament current and the plate voltage constant. When the point "a" on the curve is reached, at which the grid voltage is zero, the switch is thrown over, making the grid positive. This positive voltage is then increased in small steps and the corresponding plate currents are noted.

The curve given in Fig. 2 is interesting for the reason that it shows something that few radio fans are familiar with: that when the grid voltage is raised to a rather high value, the plate current decreases. This decrease is plainly seen in the portion of the curve marked "bc." Of course, such very high voltages as 60 volts positive are never used on the grids in receiving sets, so that we need not worry about this decrease of current. The phenomenon is interesting, however.

It is well known that since the plate is positive, the negative electrons from the filament are attracted to it. When the grid becomes positive, it also attracts some electrons, but since its charge is usually small it does not ordinarily affect the plate current.

As the positive potential of the grid increases, a point is reached at which the grid potential has an effect equal to that of the plate. This grid voltage is, of course, considerably less than the plate voltage, because the grid is nearer to the filament than to the plate. The number of electrons being ab-

Layout of the apparatus used for obtaining characteristic curves of electron tubes.

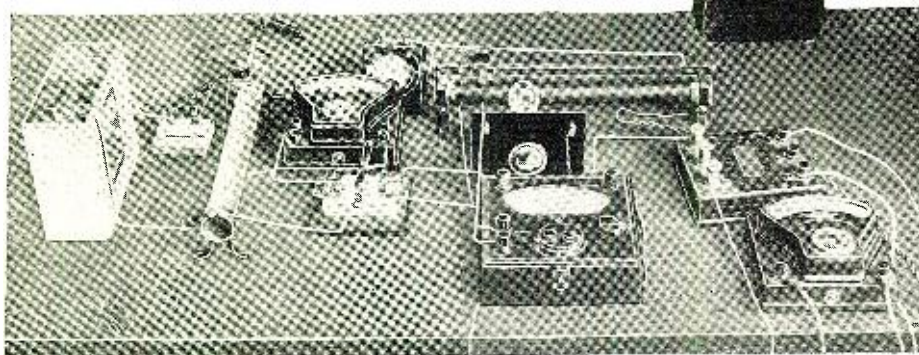

sorbed by the grid continually increases with the grid potential; these electrons should have gone to the plate. When the voltage of the grid becomes high enough there are so many electrons robbed from the plate, that the current in the plate circuit drops and the characteristic curve bends downward as in Fig. 2.

While the switching of the condenser and, consequently, the spreading out of the stations on the dial may be accomplished by the above methods, there is the disadvantage that when the dial has been rotated half way, giving a range of, say, 200 to 350 meters, the wave-length jumps immediately to 600 meters when the switch is thrown over. To tune to stations between 350 and 600 then, the dial will have to be turned in the opposite direction.

This would make the logging of the dials somewhat as shown in the illustration and would require a pointer at both the top and bottom of the dial. A much better arrangement than this can be obtained by attaching circular segments of copper to the backs of the dials which complete the connection to brass or spring copper fingers connected to the condensers. This also requires a fixed condenser with each of the variables, the value of this fixed condenser being equal to, or preferably a little less than, the capacity of one-half of the variable condenser.

The schematic diagram illustrates the idea, and the wave-length calibrations shown by ABD1. A fixed condenser, C, is connected in shunt with one-half of the variable condenser. The rotors of the variable are connected through the shaft of the condenser and to the ground.

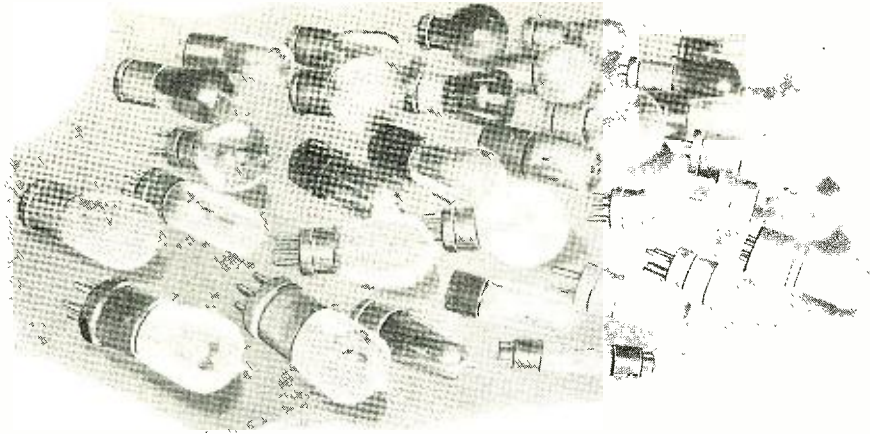

A few of the different types of tubes tested in the Radio News Laboratories.

The ground connection is shown at B. The copper segments fastened to the inside or back of the dial are also shown. The operation is as follows:

As the dial is rotated in the direction indicated by the arrow, and passes around from zero to 50 on the dial, representing a half revolution, the segment A connects the fingers 1 and 2. This will connect the condenser marked X in the circuit of the coil, leaving the other condenser out of the circuit. As the dial rotates from zero to 50 the capacity of X continually increases, so that the wave-length increases, say from 150 to 250 meters.

When the dial is rotated a trifle further, the connection to X is broken and the other part of the variable condenser, marked Y, shunted by the fixed condenser (which is equal to X), is now connected in circuit by the fingers 2 and 3. As the dial is rotated from 50 to 100 the capacity of Y continually increases, so that the wave-length will increase further, say, from 350 to 600 meters.

It is possible to adapt the ordinary gang condensers now on the market very easily to this arrangement. All that is necessary is to unfasten one set of stator plates and replace them on the other side of the condenser frame.

About Grid Leaks

By FRANCIS R. EHLE

FOR a great many years after the introduction of the three-element vacuum tube to the radio art, the use of an extremely high resistance in series with the grid of the tube was mostly a matter of hit or miss. Wireless operators, who at heart are all experimenters, found that a pencil line or a smear of ink connecting the grid lead to the grid element, made a very considerable difference in the sensitivity of their receiving set. Eventually manufacturers of wireless equipment incorporated a crude high resistance to accomplish this result.

Since the advent of radio for the broadcasting of entertainment to millions, the grid leak has come into more and more respect, and it is now considered verily "the biggest little thing in radio." Changes in tube construction, as regards the various voltages used for their operation, different types of filaments, a multiplicity of circuits, all mean a different value of grid leak for most efficient operation.

When the specifications call for a "one meg" or "two meg" grid leak, they mean that one million or two million ohms of resistance are required to enable the accumulated charge of the incoming signal to leak off the grid of the tubes in time for the grid to be free for the succeeding electric charge. A simple analogy may be made of the carburetor of an automobile. The motor is the detector tube of the receiver, the carburetor the grid leak. If the carburetor is fed too much gasoline, the motor is choked and, as a result, stops, and by the same token if the grid leak allows too much of a charge to remain on the grid of the tube, it chokes or, as we say, paralyzes. If the carburetor is fed too little gasoline, decreased power results in the motor and our analogy to the grid leak is still correct as when the grid leak is of too low a value, decreased sensitivity results in the receiver.

The grid leak may be considered as a

valve controlling the amount of electrical energy that the detector tube can efficiently take care of without overload.

Any loose connection or minute electrical defect in the grid circuit is more apt to cause noisy crackling reception than in any other portion of the receiving circuit, because in the detector tube the actual transforming of energy from the air to audible sound takes place to be amplified many times in the audio frequency portion of the set. Thus any imperfection in the grid leak, because it is in the grid circuit of the detector tube, is certain to make itself well heard in the loud speaker.

In purchasing grid leaks, great caution should be exercised to purchase only a reliable type. Carbon paper, impregnated paper or pencil mark grid leaks when examined under a microscope, look much like coarse sand paper, and when electrical current is passed through them, as is constantly occurring in the grid circuit of the detector tube, a minute arcing effect is noticed, so small as to be invisible, but its effect can easily be heard as a hissing, rushing sound. This very considerably affects the quality and sensitivity of the receiver. Use only good grid leaks—preferably metallized.

The following table of grid leak values represents the consensus of opinion of tube manufacturers:

Tube	Grid Leak Value
UV-201A or 301A	2 to 3½ Megohms
DeForest DV-6	3 Megohms
WD-11 or WD-12	3 to 5 Megohms
UV-199 or C-299	3 to 5 Megohms
UV-200 or C-300	1 to 2 Megohms

Ordinarily these values are correct.

The exact value of grid leak to use depends upon the length of time that the tube

has been in operating service, the plate voltage, and the type of circuit employed. As the value is very often a deciding factor in the sensitivity of the receiver, a number of values should be experimented with, or a reliable variable grid leak ranging from one to five megohms used.

"DX"

A radio bug in Kalamazoo
Sat tuning in on Timbuctoo,
With head-phones clamped to straining ears
For the far-off strains of the Timbucteers.

Harsh static hissed, and fried the air;
It made him cuss, he tore his hair.
When, faint as a whisper from the moon,
Came the notes of an Afric Jungle tune.

"Red Hot Papa, Aggravatin' Mama,
Tum Tum, Yum Yum, Moonshine Booze.
Hug a little, snug a little, cuddle up to Dada.
Haba Haba, Ali Baba, Baboon Blues."

A great peace entered his weary soul,
Now, near achieved was the final goal.
His mind soared up to conquests new
O'er the ether waves from Kalamazoo.

The North Pole next, past the ice and snow,
Past the land of the distant Esquimau;
But, sudden the static left the air
And his spirits sank in cold despair.

For,

The announcer, very sad to relate
Spoke from nearby in his own home state.
And he said: "This is Station BUG
Broadcasting latest jazz melody.

Saturday night at ten P. M.
We will take the air again;
If you've enjoyed our jazz tonight,
Send us a wire, or phone, or write."

History of Radio Inventions

By A. H. MORSE, A.M.I.E.E., Member I.R.E. New York*

PART III

1908. Professor J. A. Fleming filed an application for a patent on June 25, on a diode having a filament of tungsten and a cylindrical plate of "copper or other metal." On December 10 following, he modified this by changing the material of the cylinder to carbon. He also made provision for the "B" battery effect, and secured a patent on the combination on April 15, 1909. (Br. Pat. 13,518/08; U. S. Pat. 945,619.) (Fig. 22.) Such a device never came into general use, and one is forced to the conclusion that, despite the invention of the triode, the diode at this time was still in an embryonic stage. (It should be noted here that DeForest's application for a British Patent 1,427/08 on a triode having a filament "preferably of metal" was accepted on April 30, 1908, and he disclosed a filament of platinum or tantalum in the specification of his U. S. Pat. 841,387 of January 15, 1907.)

1910. Professor R. A. Fessenden invented a two-tone method of transmitting, whereby dots and dashes could be made of equal length. As a method of economizing "line-time," this invention may yet have considerable application. (Br. Pat. 2,617/11.)

1911. R. von Lieben, E. Riesz and S. Strauss demonstrated that the triode could be used as a proportional relay of radio frequency currents. There is little doubt that it was the reduction to practice of the triode by Von Lieben and his associates which restarted triode evolution in other countries. (Br. Pat. 1,482/11.) The use of a "C" battery is disclosed in the specification of this patent.

G. Marconi invented a balancing-out method of duplexing spark stations, which marked an important step in the evolution of spark telegraphy. (Br. Pat. 13,020/11.)

1912. According to a judgment of the U. S. Court of Appeals of the District of Columbia, dated May 5, 1924, Dr. Lee DeForest is to be credited with the first in-

vention of the regenerative circuit of the triode on August 6, 1912. The Appeal Court proceedings were on a long-fought interference and not an infringement issue, and while they were in progress the invention in question was made the subject of many issued patents in different countries, notably to Franklin in England (13,636/13), Armstrong in America (113,149), and Meissner



Dr. Irving Langmuir of the General Electric Co. staff, who has done much valuable work in perfecting the vacuum tube.

in Germany (291,604, April 10, 1913). The regenerative circuit is one that involves a certain critical degree of coupling between the two oscillatory systems of the triode, and this coupling may be obtained by mutual inductance (as in Fig. 23), mutual capacity, or mutual impedance, or by combinations thereof. It is variously termed the regenerative, reactive, feed-back or tickler circuit.

CHAPTER II AFTER 1912

With the discovery that the triode could be made to function as a generator of alternating current of any desired frequency, it became apparent that there was a prospect of evolving a radio transmitter that would approximate to the ideal. That prospect has now been realized, and the triode has passed the acid test of commercial application.

Engineers naturally look with some indulgence upon the alternator as a radio frequency generator, because of its theoretical simplicity; but it seems extremely likely that the triode and its derivatives will not soon be superseded as the keystones of all transmitters of moderate power. Especially is this likely in view of the fact that only one basic technique is involved. Moreover, the triode is quietly revolutionizing the arts of wire telephony and telegraphy, and must soon find important applications to the submarine cable, hence it is proving the greatest factor in bringing about that closer cooperation between the technicians of the various forms of telegraphy and telephony, which is so desirable, and which has had such an enthusiastic advocate in General G. O. Squier.

Technicians appear to have been waiting for the development of the triode and its use as an oscillator in order to put into service many of the inventions and discoveries of the previous thirty years, even including some of those made by Hertz in 1888, such as the use of the short wave. (Fig. 28.)

Fessenden's interference receiver (or

Heterodyne) invention found no commercial application until the triode was available; but at the same time the triode so simplified amplification that it provided an efficient alternative method of detecting continuous waves.

Technically, there is nothing now to preclude the widespread application of guided-wave telephony, by the use of which most of the benefits of other than graphic arts may be made available to all whose homes are served by an electric lighting system.

WIRED RADIO

Already commercial telegraphy and telephony have, in many countries, been revolutionized by guided-wave methods, and the use of the triode. Moreover, these two agencies have been the means of saving thousands of tons of copper. Every electrical conductor is now potentially a telephone or telegraph line or both, and it may be the conveyor of grand opera. Appropriate receiving methods are disclosed in the specifications of British Patents 15,718/11 to Erskine Murray; and 3,191/14 to Squier.

Guided-wave telephony, or "wired-wireless," appears to have been first proposed by Hutin and Leblanc in 1892 (Br. Pat. 23,892/92; U. S. application (?) 510,658), developed by them as disclosed in the specifications of their later patents (U. S. 596,017 and 628,246 Br. 2,107/96), and later by Leblanc alone (U. S. Pat. 857,079). The idea is also crudely embodied in the specification of British Patent 1,555 granted to E. G. Foresio in 1900. In later years the method has been developed by G. O. Squier. (U. S. Pats. 980,356, 980,357, 980,358, 980,359; Br. Pat. 30,003/10.)

Guided-wave telegraphy would seem to be the natural evolution of the harmonic systems disclosed by Pupin and others many years ago.

While it would be rash to prophesy that there will be no more startling and valuable inventions in the radio field, it is safe to say that, if none are made and vested interests

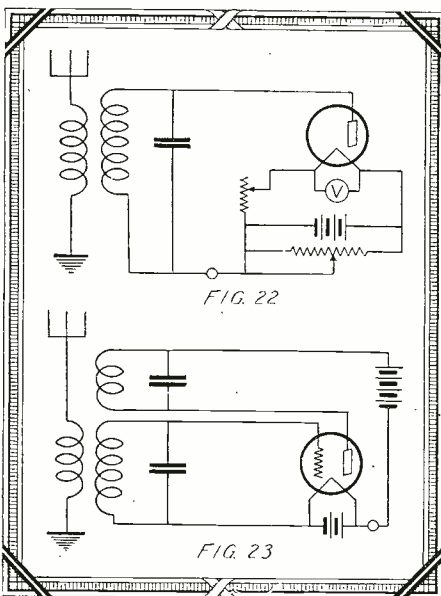

Fleming's diode circuit and the fundamental regenerative circuit.

*Late Supt. Dom. DeForest Wireless Telegraph Co. and United Wireless Telegraph Co.; Engineer, Marconi's Wireless Telegraph Co.; Wireless Adviser, Indo-European Telegraph Co.; Managing Director, Marconi Wireless Telegraph Company of Canada.

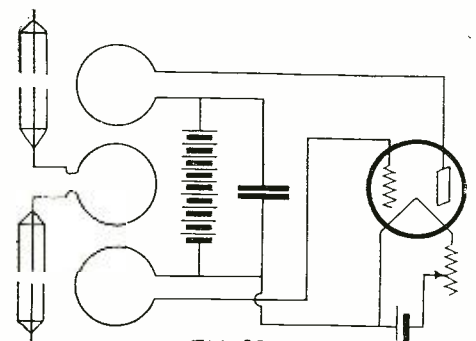

Short-wave circuit as conceived by Hertz in 1888.

permit, the development and practical application of the art may steadily progress for many years to come on the basis of present knowledge.

Already speech has been transmitted from a vessel 150 miles at sea in the Atlantic to an island 30 miles off the Californian coast in the Pacific—being relayed over the transcontinental telephone wires; and a regular service—part wire and part wireless—has been open to the public since the summer of 1920.

A comparatively recent practical development consists of the suppression of the carrier-wave and one of the side-bands in radio

telephony. In the author's humble opinion, this marks the culmination of technical advance during the last ten years, although it has not yet had any wide application. In view of present hopes and prospects of dependable, if not continuous, long-distance communication by means of comparatively low power and short waves, it now appears likely that a limited secret trans-ocean radiotelephone service will soon be available to the public. (See Proc. I.R.E., October, 1922, and February, 1923, papers by Lloyd Espenschied and R. V. L. Hartley, respectively; also a paper by Dr. H. W. Nichols, Journal I.E.E., London, July, 1923.)

Great inventions, as often as not, are the result of little effort; but the development of inventions so that they may be applied to commercial uses, often entails the closest study and prolonged effort. A classic example is that of the Bellini-Tosi Direction Finder, which, although of great inherent merit, was ten years old before H. J. Round, again with the aid of the triode, made it of immense value to Britain and her allies during the Great War. Round's later work in connection with the development of the valve transmitter, although not characterized by any basic invention, is historical.

By a stroke of genius somebody discovered that one of the Bellini-Tosi aerials could be inverted. This meant a very great advantage on shipboard, where it is convenient to have the fore-and-aft aerial with its base uppermost and the thwart-ship aerial with its apex uppermost.

A later development of great importance was an aperiodic aerial, involving tuning of the search-coil circuit only, and thus facilitating the essential expedition of successful direction-finding. (Br. Pat. 149,066 to H. J. Round and G. M. Wright.)

Efficient modified forms of direction-finding apparatus which have found wide practical application have been evolved by J. Robinson in England (Br. Pats. 134,342, etc.) and by F. A. Kolster in the United States (Br. Pat. 138,318), the former being particularly applicable to aircraft.

A frequent bone of contention in radio patent litigation is the grid leak. (See Patents, U. S. 1,282,439, Br. 147,148 to Langmuir; and U. S. 1,377,405 to DeForest.) In a somewhat lesser degree, questions arise regarding the "C" battery or the application of a steady voltage to the grid of a triode. (See Patents, Br. 1,482/11 to Von Lieben et al; U. S. 1,038,910, 1,231,764 to Lowenstein; U. S. 1,282,439 and Br. 147,148 to Langmuir; Br. 13,248/14 to Round; and U. S. 1,426,754 to Mathes.)

The growing use of tuned radio frequency amplification lends a particular interest to British Patent 8,821/13. (U. S. Pat. 1,087,892 to Schloemilch and Von Bronk.) This patent is equally relevant to the modern practice of "reflexing," or amplifying both audio and radio frequency in a single triode.

MODULATION

Undoubtedly one of the greatest feats of radio engineering within the last few years has been the development of distortionless modulation—over the whole gamut of orchestral frequencies—of energy calculated in kilowatts.

There have been many refinements in receiving arrangements, mostly involving the basic inventions of the triode, heterodyne and regeneration, in combination with directive aerials and note-tuning.

In 1919 Professor L. A. Hazeltine, of the Stevens Institute of Technology, Hoboken, N. J., evolved the "Neutrodyne" method of reception which has become extremely popular. (U. S. Pats. 1,450,080 and 1,489,228.) It has been claimed by those interested that the following patents are also relevant to the "Neutrodyne" method, namely, U. S. 1,183,875 to Hartley; and U. S. 1,334,118, Br. 119,365 to Rice.

Another receiving method which has lately become very popular, particularly in America, is the Super-heterodyne. In this method the "beat" is adjusted to and amplified at a convenient and usually definite super-sonic frequency. See Patents (British) 133,306, October 1, 1918, to L. Levy; 135,177, June 18, 1918, to Siemens and Co.; and 137,271, December 30, 1918, to E. H. Armstrong.

Despite the oft-recurring reports of their slaughter, "atmospherics" are still the bane of traffic superintendents. Nevertheless, if, as one supposes, they (the atmospherics) are merely additive, it seems certain that someone will find a way to avoid their interference with the signal that is always there. Meantime, by means of directive aerials, sharp tuning, and proportional recorders, their effects are greatly mitigated.

Fading is still with us, and its cause remains to be discovered.

Freaks also remain to be explained. Dr. W. H. Eccles has suggested that they are the equivalent of the mirage in optics, and that as such they are a law unto themselves.

It is appropriate here to note the fact that in 1920 there passed away one of the earliest workers in the field of wireless telegraphy, in the person of Senator Augusto Righi, under whom Marconi studied at Bologna. Apropos of recent short wave developments, it is recorded that, over twenty-five years ago, Righi succeeded in generating Hertzian waves of a length of only 2.5 centimeters.

CHAPTER III THE FUTURE

Whatever the future may have in store, it seems unlikely that there will be any great improvement in results, but rather in their dependability and the methods of obtaining them.

Inventive genius will naturally be directed toward effecting economies in the ether, in connection with which serious problems are already arising. It is inevitable that there will be great developments in note-tuning, and it may be that modulation or "chopping" of telegraph signals will be effected at the transmitter. In such case, transmitting stations will be licensed as to both the radio and audio frequency characteristics of their signals.

Meantime, considerable economies of "line-time" could be effected on the congested 600-meter wave in the North Atlantic, by the elimination of the words "Latitude North, Longitude West," from the positions which are signaled to shore, and which constitute a considerable proportion of the traffic on that wave. "Latitude" is invariably given first, and most of the ships regularly in the North Atlantic trade are never in *South* Latitude or *East* Longitude. A rule might therefore be established that Latitude will, as now, always be given first, and that the four words quoted above will be deleted, excepting

(Continued on page 100)



Nikola Tesla, world-famed experimenter, whose researches in high voltages have changed the course of the electrical and radio art.

All About Verniers

By SYLVAN HARRIS

This article gives a thorough discussion of vernier attachment to condensers and the effect of their back-lash on tuning.

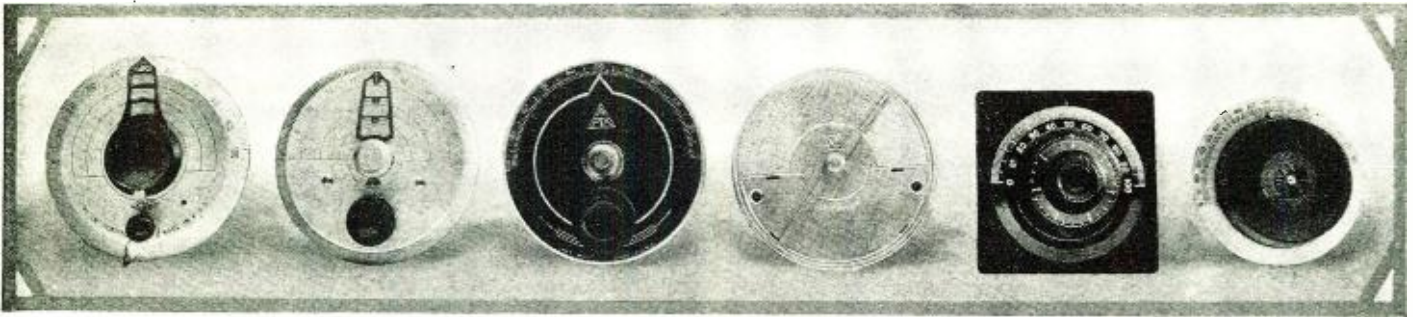

Courtesy of Sheffield Trimming & Stamping Corp.

Courtesy of Phenix Radio Corp.

Courtesy Apex Elec. Mfg. Co.

Courtesy of X-Akt Radio Corp.

Courtesy of E-Z-Toon Radio Co.

Courtesy of Walbert Mfg. Co.

A few of the dials tested in Radio News Laboratories

FOR some reason or other the radio fraternity is about the most exacting crowd that ever peopled the face of the earth. It is certainly a good thing to be this way, but, as in all other phases of life, there should be a limit to it. This human propensity can very well be illustrated in considering the question of vernier dials.

Stations have been crowding upon one another for a long time; manufacturers have been trying to find ways and means for the radio fan to tune easily to these multitudinous concerts without the distasteful trouble of having "someone else on the line."

As we have said in the preceding paragraph, the manufacturers have been trying to find the solution to the problem. Some of them have turned out vernier dials that may be classed as praiseworthy. Others have turned out dials which are not so good. This case is a relatively inconspicuous parallel to the condenser situation of a year or so ago.

The need for a more complete study of dials was brought to our attention by some dial manufacturers who claimed that several of their competitors were making these wild claims. To find the truth of the matter we wrote to them all, and asked them to send us samples to test and study in the RADIO NEWS LABORATORIES. Not all of them complied with our request, but a sufficient number of them did, so we were able to get enough material and assistance to obtain a very comprehensive view of the field. At the same time we feel sure that what we have learned, and are about to describe, will be, in a very fair manner, representative of the whole field of vernier dials.

WHAT "VERNIER" MEANS

To begin with, let us find out what is meant by the term "vernier", and why it is

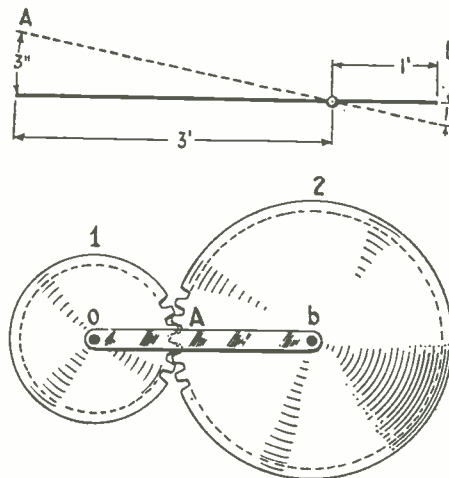

Fig. 1 illustrates the simple principle of lever action.

Fig. 2. The application of the lever principle to a gear train.

applied in the way we radio bugs apply it. Webster says:

"Vernier—A short scale made to slide along the divisions of a graduated instrument, etc., etc. . . . It is so graduated that a certain convenient number of its divisions are just equal to a certain number, either one less or one more, of the divisions of the instrument, so that parts of a division are determined by observing what line on the vernier coincides with a line on the instrument."

This is the definition that engineers have always given the word vernier, and how it ever came to be given to what is merely "slow-motion control" is beyond the ken of the writer. At any rate, there is not one slow-motion dial of any kind so far on the market that can fall under the classification of verniers as defined in Webster.

Well—it doesn't make a great deal of difference, practically. It would amount to the same thing if we used any old word, provided we were all agreed as to what the term means when it is used.

As we have said before, the stations nowadays are becoming very crowded on the condenser dials, and it is on account of this that we are compelled to tune rather accu-

ately. The human digits are not sufficiently sensitive, as a rule, to do such close tuning quickly and accurately, so we higher animals with the superior intellect have to employ purely mechanical means for overcoming our deficiency.

Hence, we employ slow-motion affairs, and in keeping with this understanding of what we will now term "vernier dials", we will eliminate all those dials which are advertised as verniers, but which do not have any slow-motion arrangement about them. Also, remember that what we term slow motion in this article refers to any kind of an arrangement in which a small motion made by the hand of the operator produces a correspondingly much smaller motion of the condenser plates.

The reader must also remember that all true "vernier" dials are not included in this article. We were unable to get them all; so that if it happens that some are omitted, it does not mean that they were not worth considering.

The design of vernier dials is not an electrical proposition; it is a purely mechanical proposition. Naturally, the first thing that the mechanical engineer or the designer turns to in obtaining slow-motion apparatus is the lever in any of its many forms, including the gear train.

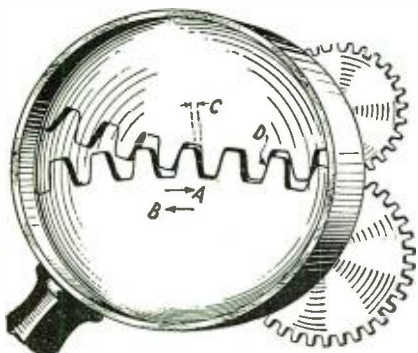

Fig. 5. Turning in direction A, no back-lash is found, as the gears are in contact as at D. On reversing the motion, the play at C must be taken up.

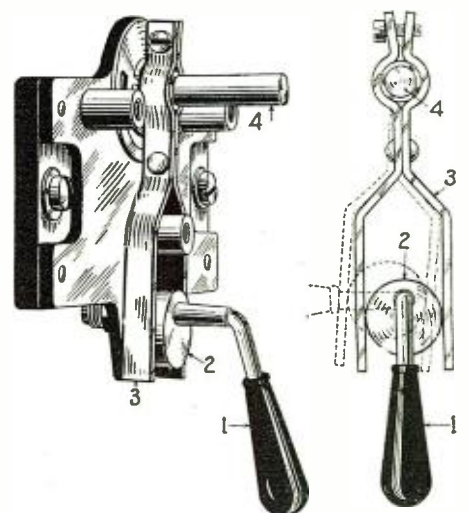
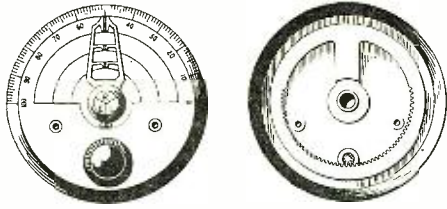

Fig. 4. This is a well-known type of slow-motion device. The turning of the eccentric (2) moves the stirrup (3) slowly. The latter turns the condenser shaft (4) through a friction collar on the shaft.



A simple device using a pinion and internal rack.

THE LEVER PRINCIPLE

As a simple means of illustrating the principle of the lever, suppose we look at Fig. 1. Here we have a lever supported at a pivot. The length of the lever on one side of the pivot is three feet, and the length on the other side is one foot. Then, if we take hold of the lever at A and move it up three inches, the end of the lever at B will move down one inch. The slow-motion idea is very apparent. We have moved the hand through a distance of three inches while the other end of the rod, which may be attached to anything we desire, has only moved one inch.

A train of gears is nothing more nor less than a combination of lever actions, in which the lever arms may be considered the radii of the separate gear-wheels. The

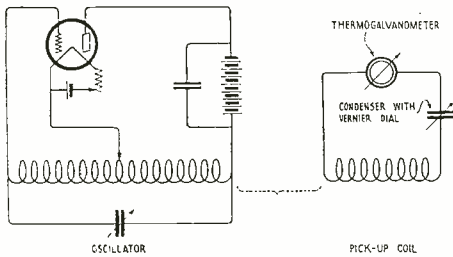

Fig. 6. The circuit diagram of the Hartley oscillator and resonant circuit used to measure the back-lash.

circumference of one gear rolls around the circumference of the other gear, so it is evident that if these two circumferences are not the same in length, one gear will have to make more than one complete turn while the other is making exactly one turn. For instance, if in Fig. 2, the radius OA is one-third the radius AB, the circumference of gear 1 will be one-third the circumference of gear 2. This means that gear 1 will have to make three revolutions in order to turn gear 2 around one complete revolution.

To tie up these ideas with vernier control of condensers, gear 1 may be supposed connected to the knob on the panel which we turn, and gear 2 be fastened to the condenser plates, which are to be turned.

Another simple method of obtaining slow motion is shown in Fig. 3. This also works on the lever principle, the lever in this case being the knob turned by the hand. The complete action of this arrangement is clearly shown so that no more words are required in explanation, with the exception of a few words on the attachment of the slow-motion linkage to the condenser shaft. This

is accomplished through a friction collar binding on the shaft. A large dial of the ordinary variety may be fastened to the shaft of the condenser, and the latter turned through large angles quickly to obtain a rough setting. The final accurate adjustment of the setting is obtained by turning the vernier knob.

Another design of vernier attachment working on the same principle is indicated in Fig. 4. This design is so well-known among the radio fans that nothing more need be said about it.

There are other designs like these on the market, but they are all more or less alike. The class of vernier dials which employs a train of gears becomes very complicated, and will be left till later on in this article, while we discuss, in the meantime, the idea of back-lash.

CAUSES OF BACK-LASH

Broadly speaking, back-lash is lost motion or "play" in the action of the slow-motion arrangement. To illustrate the idea, let us suppose the bearing at A, Fig. 2, is loose. As we begin to turn the knob, the parts will have to move until this looseness is taken up. The distance, or rather, the angle through which the knob has to be turned before the condenser shaft begins to move is the back-lash.

As another illustration, consider Fig. 5. Here two gears are shown which have become worn, or which were inaccurately cut or stamped. The teeth on the two gears do not mesh exactly.

Suppose the gears happen to be in the position shown in the figure, being turned in the direction A. There is no lost motion in this case as the teeth of the two gears are in contact on the right side, as indicated at D. When, however, we turn the gears in the direction B, the lower gear will have to be turned a slight distance before its teeth will begin to push the teeth of the upper gear. The distance through which the lower gear will have to be turned before the upper one begins to move is the back-lash.

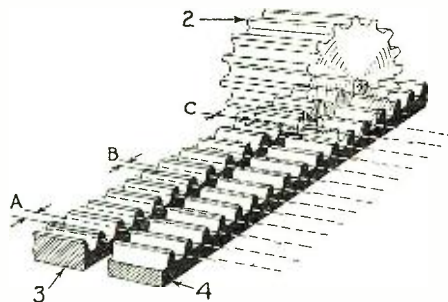

The principle of the dial in the upper right-hand corner is explained by this diagram. There is one more tooth on rack (3) than on rack (4). The distance between the teeth decreases from A to C, as shown, and at the position of the gear shown the distance is zero. At this point the gear "jumps" a tooth, thereby gaining or losing, depending on the direction of motion.

When there are a number of gears in a train such as is often used in vernier dials, it is evident that all the small amounts of

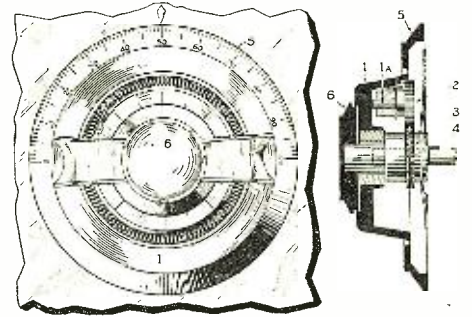

This dial utilizes the slip-tooth principle shown in the middle of the page. 5 is the main dial. 6 turns the slip gears (3) and (4), which cause 2 to turn. 2 is mounted on the shaft (1A) fastened in the main dial (1). 5 is the scale, fastened to the condenser shaft.

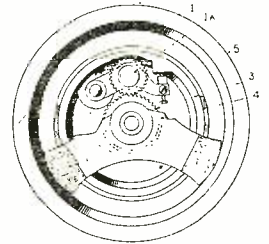

back-lash between every pair of gears in contact is additive, so that when there are a half-dozen or more gears, the back-lash may become very appreciable, no matter how accurately the gears are cut or stamped.

In our studies of the matter in the RADIO NEWS LABORATORIES, and in our tests of the

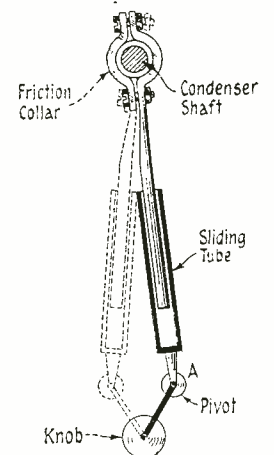
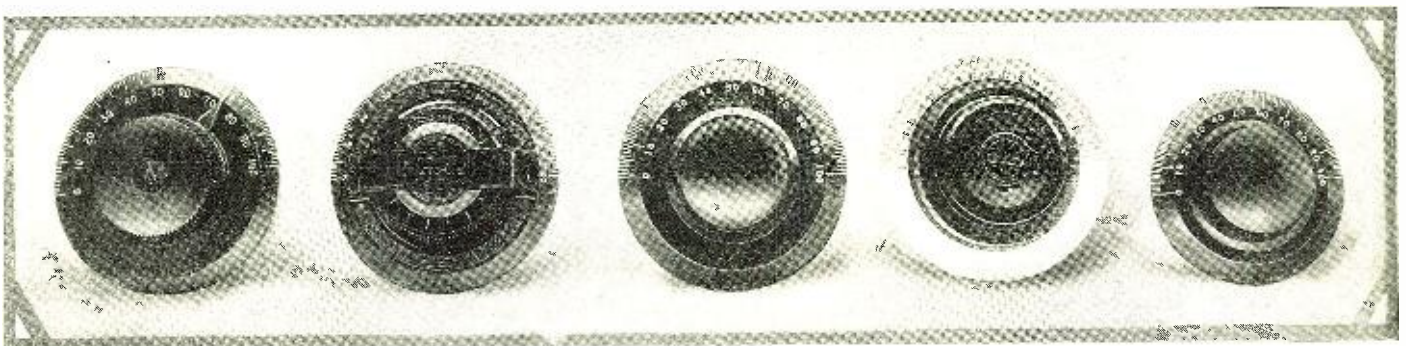

Fig. 3. The action of this slow-motion device is illustrated clearly by the broken lines. As the knob is turned, the tube slides on the rod, the pivot A describing an arc about the center of the knob.

various makes of the vernier dials, we have found that almost all the vernier dials that have come into our hands, the operation of which depends on gear reduction, have measurable back-lash. It seems that there are always weak points in every gear train. Generally the back-lash lies between the teeth of the adjacent gears, as illustrated in Fig. 5, but it is often found that besides this, there is play in the bearings which carry the gears.

Consider Fig. 3. This shows another source of back-lash. Suppose that the tube which slides upon the rod connected to the condenser shaft does not fit the rod accur-



Courtesy of Chas. A. Branston Inc.

Courtesy of Jewett Radio Co.

Courtesy of National Co., Inc.

Courtesy of Mydar Radio Co.

Courtesy of National Co., Inc.

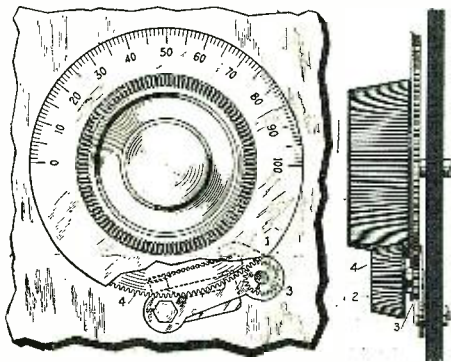

A simple geared dial in which a pinion of fibre is kept closely in mesh with a brass gear on the dial by means of the spring shown.

ately. This play in the tube must be taken up before the condenser can be moved and this together with play in the bearings and joints may make the back-lash considerable.

WHY BACK-LASH IS BAD

Now let us understand why back-lash is objectionable in vernier dials. Suppose we are tuning to a certain station and are having difficulty in doing so because the locals are on. Very fine adjustment of the dials is required and the regeneration, if it is a regenerative set, is pushed to the limit. We gradually turn our condenser dial to the right, approaching the point of exact resonance. We have to pass this point of resonance to find out where it is, for resonance is indicated by the maximum signal obtainable. We can't tell whether the signal strength has attained a maximum until we have passed the maximum point.

We stop turning the dial the instant we find we have passed the maximum point, and it is now necessary to come back, turning to the left. This motion to the left is generally very small. Now suppose we have considerable back-lash in our dial. We keep on turning the dial slowly and nothing changes. All of a sudden when all the play in the dial has been taken up, the condenser plates move, and invariably we go past the point. This happens time and again, with the result that we soon come to the conclusion that a vernier dial with back-lash is almost as bad to use as the ordinary dial. It has been our experience, as has been said before, that nearly all dials which use gear trains have measurable back-lash.

MEASURING BACK-LASH

There are two places in a vernier dial where back-lash can occur, viz: between the hand-knob and the dial, and between the dial and the condenser. Some manufacturers have claimed that no harm can come

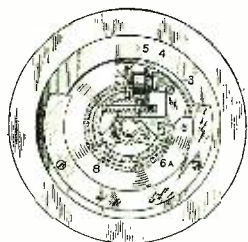
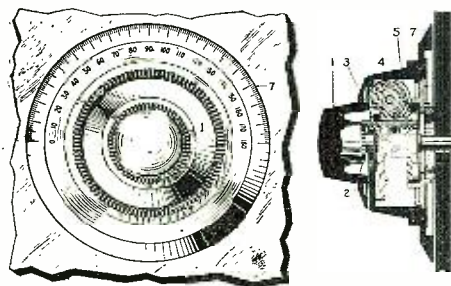

Knob (1) turns gear (2), which is meshed with a double-faced gear (3) on the under side. The upper side of 6 meshes with 4, which carries on its shaft the worm (5). The latter drives gear (6), which is fastened to the shaft (8).

from having a slight amount of back-lash between the knob and the dial. This is not so, for it is the motion of the hand in relation to the motion of the condenser plates that we are concerned with, besides the fact that the motion of the dial is generally too small to read on the scale. The fact remains that back-lash is objectionable in either place.

We shall now explain by what method the back-lash was measured. The action of the ordinary oscillator and resonant circuit is generally well understood. In Fig. 6 is shown a simple Hartley oscillator coupled to a pick-up circuit which contains a thermo-galvanometer and a condenser which has mounted on its shaft the dial to be measured. The dial is set at any convenient portion of the scale and the wave-length of the oscillator is adjusted so that maximum deflection is obtained in the galvanometer. The two circuits are thus in resonance.

If now the oscillator is left untouched, and we make a change in the capacity in the pick-up circuit, the indication of the thermo-galvanometer will decrease rapidly, since the circuits will no longer be in resonance. We must be careful, while making these changes, not to change the coupling between the oscillator and the pick-up circuit, nor the adjustments of the oscillator.

When the condenser of the pick-up circuit

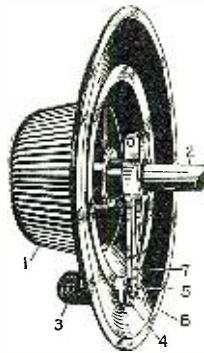

The action of this slow-motion device is simple and is similar to that shown in Fig. 4.

The eccentric mounted on the dial drives the shaft through a friction collar, as shown at (2). The motion is indicated by the dotted lines.

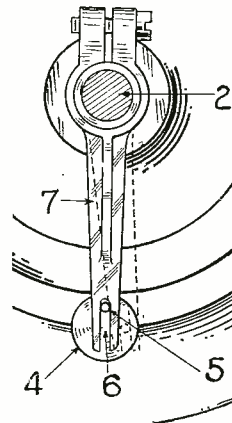

is brought back to the capacity which it had originally, the circuits will again be in resonance and the thermo-galvanometer will indicate the same value of current in the pick-up circuit. It is on this principle that the test is based.

The oscillator is brought to resonance with the vernier dial at any convenient setting, without changing the oscillator or the coupling between the two circuits. The setting of the vernier dial and the reading of the thermo-galvanometer are noted. The vernier dial is then thrown far around to the right and slowly brought back. The difference between the reading of the vernier dial, when the same galvanometer indication is obtained, and the original reading of the dial, gives the back-lash.

This back-lash was measured in all cases by the angle through which the hand had to be turned to take up the play. With dials that had stationary scales, that is, scales which are fastened to the panel and do not move, all that was necessary was to fasten a small piece of wire, by means of sealing

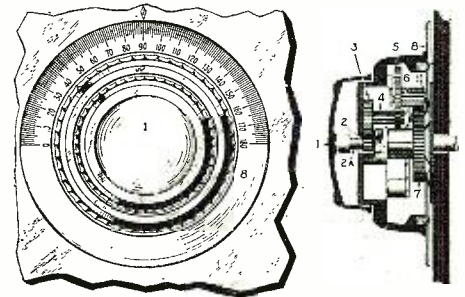

This shows a sectional and outside view of the arrangement shown in plan immediately below.

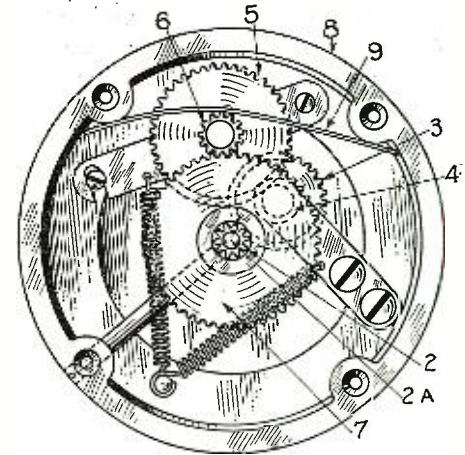

The dial is held by friction against the panel. Turning knob (1) transmits motion through the gears numbered in succession from 2 to 7 inclusive. The condenser shaft is fastened to 7. 9 is a flat spring which presses against 6 to keep it tightly in mesh with 7 and also 5 in mesh with 4. 8 is the calibrated dial which moves with the condenser shaft.

wax, to the knob. This piece of wire acted as a pointer on the main scale. In cases where the calibrated scale of the dial revolved, it was necessary to fasten a special scale under the knob which was turned, and the back-lash was measured by the angular motion of the wire pointer on this scale. In other words, the back-lash was measured with reference to a fixed scale on the panel of the receiver. A photograph of the apparatus used in RADIO NEWS LABORATORIES and the arrangement of one of the dials is shown.

To go into a detailed discussion and description of the many types of vernier dials on the market would be an endless job. Furthermore, a mechanical description of how they operate would be very tedious and tiresome reading. For this reason, we have limited our description of the operation of the various well-known types to the captions accompanying the diagrams. Sectional views have also been shown and the photographs have also been numbered in accordance with the diagrams. The captions explain in detail the workings of the mechanisms.

(Continued on page 125)

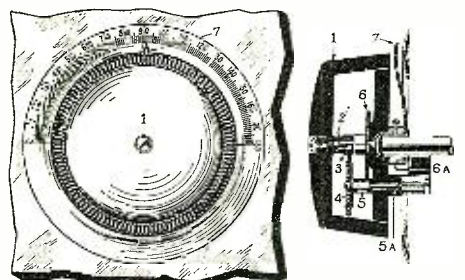

This arrangement is comparatively simple. Knob (1) turns pinion (2), transmitting motion through 3, 4, 5 to 6. Gear 6 idles on the shaft through 2, and carries the condenser shaft. The whole is anchored against the panel by the springs shown. 7 is the pointer.

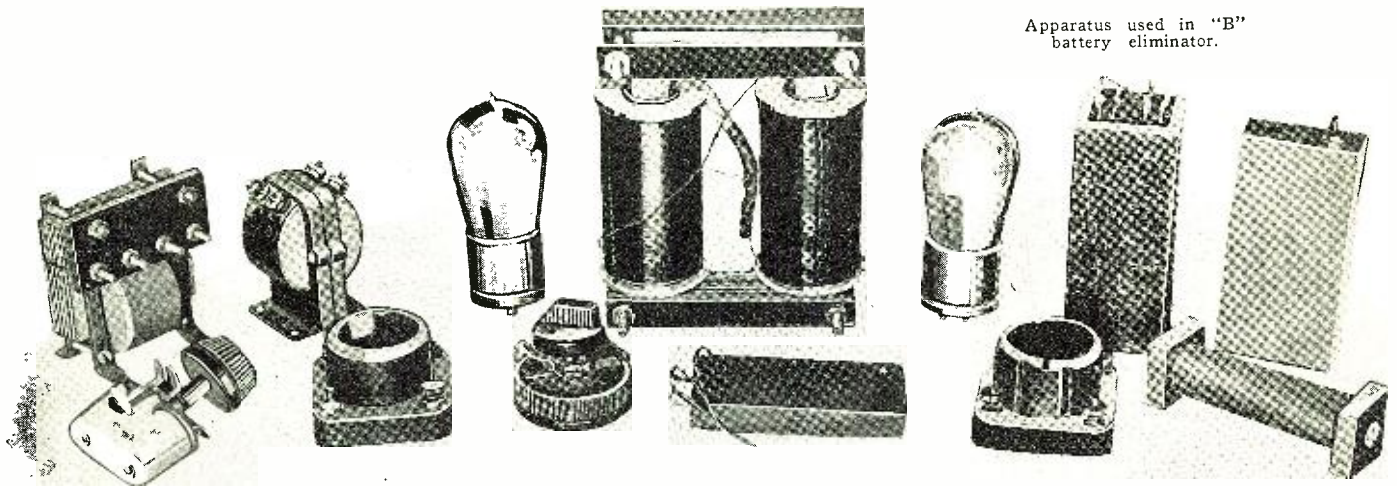

Apparatus used in "B" battery eliminator.

Further Notes on "B" Battery Eliminator from Standard Parts

By DONALD E. LEARNED

IT sometimes happens, due to overload on the local transformer, that the lighting voltage during the early evening is too low to give satisfactory results with the "B" battery eliminator described in RADIO NEWS for May. This is easily provided for in the full wave scheme shown by utilizing the extra winding (marked "dead") to boost the output voltage of one of the rectifiers. This is done by connecting it in series with one of the secondaries by means of a tap switch, as shown in Fig. 1. This switch is also useful to the experimenter in maintaining the output voltage on multi-tube sets or when using stale tubes as rectifiers. Be sure that the windings are so connected as to assist each other. Also bear in mind that the output voltage may climb to over 200 volts with this connection, which may paralyze tubes, if applied without discretion.

The writer also wishes to call attention to two errors in the diagrams for May. The repeating coil should be "No. 17 Repeating Coil," the retardation coil should be "Retardation Coil" and the "BRT" should show against the lower pair of windings to indicate "Bell Ringing Transformer." Also the sub-title in Fig. 1 should read, "four microfarad condenser—2 two's or 4 one's in parallel."

When properly constructed, with efficient lighting chokes, the eliminators described in the May issue and the modification shown herewith

ELIMINATOR FOR OPERATION ON DIRECT CURRENT

The above described eliminators are not

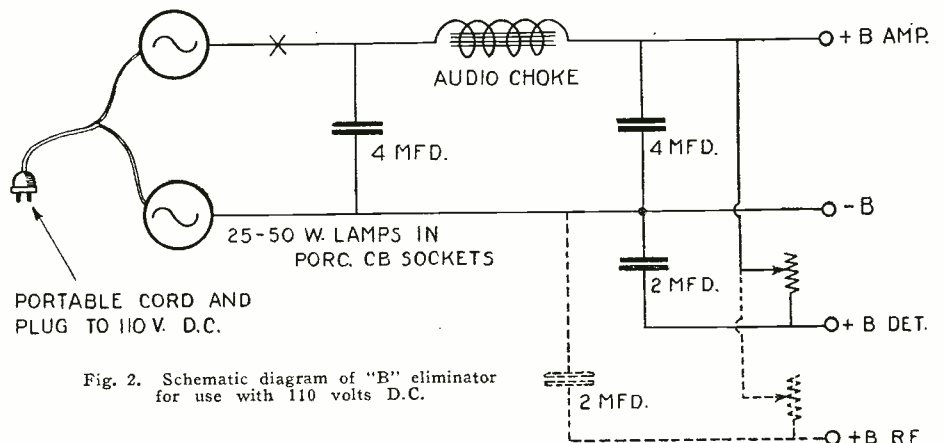

Fig. 2. Schematic diagram of "B" eliminator for use with 110 volts D.C.

will not pass any alternating current hum to the set. However, such a hum may take place from too close proximity of the eliminator to the radio set. If all coils of the eliminator are iron-clad, there should be no trouble in operating quite closely.

to be used on direct current. If such current is at hand, it may be used after passing through a filter, to shut out line noises and commutator ripple, but no rectification is necessary. Unfortunately, the set cannot be isolated from the house line with such devices, therefore the peak voltage will be that of the line, and it will be impossible to increase it. Certain precautions must also be exercised when using such a device. However, the output voltage will not decrease appreciably with the increased load, and the device will supply an almost unlimited number of tubes.

The device for D.C. is also simpler to construct and costs less to build and operate, since no rectification is needed.

The apparatus required to build the direct current "B" battery eliminator is listed below:

- 5 2-mfd. (or 10 1-mfd.) telephone condensers.
- 1 Audio choke (retardation coil or secondary of audio transformer).
- 1 Variable resistance, 10,000 to 100,000 ohms.
- 3 Binding posts, marked -B, +B and +B Det.
- 2 Porcelain cleat-base sockets.
- 2 25- or 50-watt lamps.
- 10-Inch extension cord and plug.

Suitable cabinet and panel or baseboard. The apparatus is wired as shown in Fig. 2. (Continued on page 88)

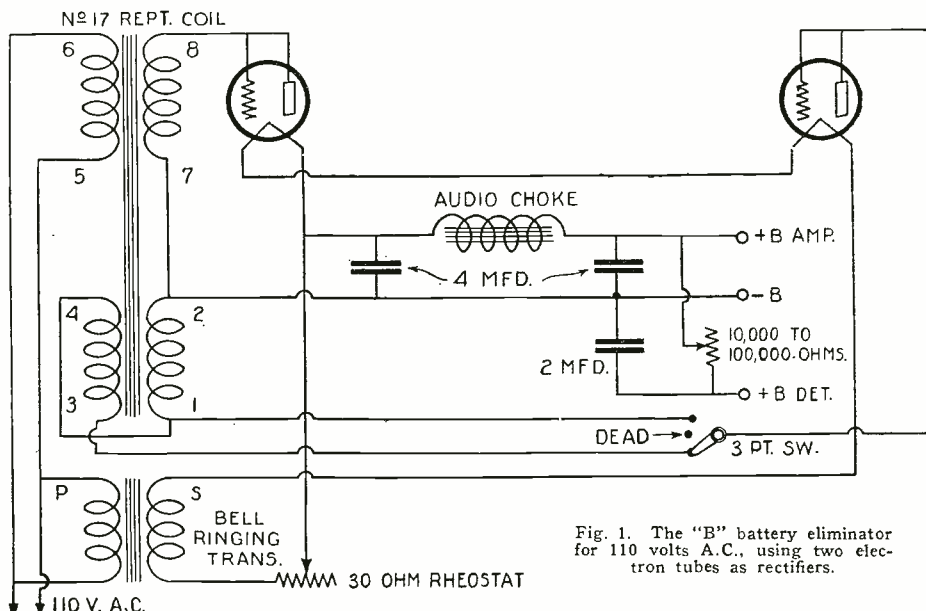
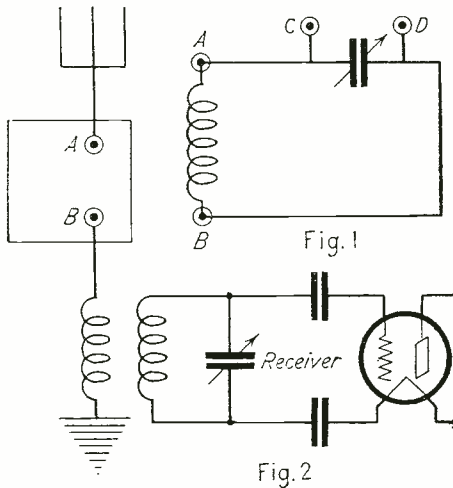

Fig. 1. The "B" battery eliminator for 110 volts A.C., using two electron tubes as rectifiers.

A Simply Constructed Wavemeter

By JOSEPH RILEY

One of the most useful instruments that the experimenter can have on the bench is herein described. Its construction and operation are very simple and may be mastered with a little study.



Circuit diagram of the wavemeter and its connections in the receiving circuit.

pair on the side of the box, and the other pair on the top, as indicated.

Several coils were constructed to be used with this condenser to form a wavemeter. Specifications for these coils follow.

USES

This wavemeter may be used either as a wavemeter or as a wave trap. The circuit diagram is shown in Fig. 1, having the terminals marked as in the photograph. When used as a wave trap, the connection is as in Fig. 2, showing the terminals A and B, connected in the antenna circuit. This connection affords a simple way to calibrate the wavemeter roughly. The receiving set is tuned to the broadcast wave-length, and the wavemeter condenser is gradually turned until the signals disappear. This is the setting of the wavemeter which puts it in resonance with the incoming waves and the dial setting is to be plotted on the curve against the wave-length. Such a curve is shown in Fig. 2. There will be three such curves, one for each coil, for three different wave ranges.

A more accurate way of calibrating a wavemeter is to receive the signals on a three-circuit tuner, as shown in Fig. 4, having the tickler coil adjusted rather close to the oscillating point. Bring the meter to within about half a foot of the tuning coil and gradually turn the condenser dial. When the meter is in resonance with the incoming waves, a howling will be heard in the phone and the dial setting of the wavemeter can then be plotted against the wave-length of the station received as obtained from a list of broadcast stations.

There are many uses to which the wavemeter may be put, as for instance, the quick measurement of capacity and inductance, as well as the measurement of wave-length or frequency. To measure the capacity of a condenser, the capacity of the wavemeter condenser must be known for every setting of the dial. If the experimenter has no friends who can calibrate his condenser for him, he can write to the manufacturer of the condenser and obtain a calibration curve which will be sufficiently accurate for many purposes.

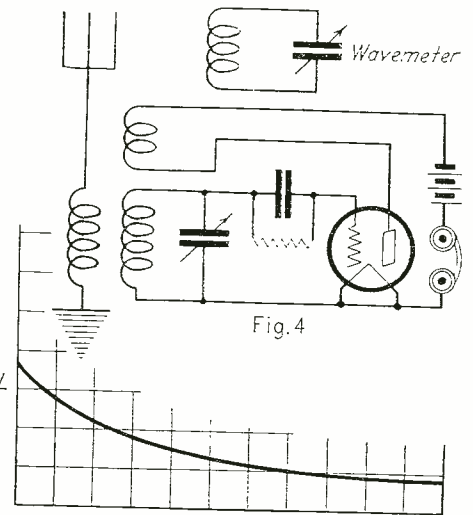

Method of calibrating a wavemeter with a three-circuit receiver. Below is a wave-length curve.

CAPACITY

In making the measurement of an unknown condenser, the latter is connected to the points C and D of the wavemeter; having the unknown capacity set at the dial reading, it is required to make the measurement. The wavemeter coil is then brought into proximity with the three-circuit tuner as in Fig. 4 and tuned to resonance. The capacity of the wavemeter condenser is noted, and the unknown condenser disconnected from it. The wavemeter is again brought into resonance with the *same wave* being received by the three-circuit tuner and again adjusted to resonance. The meter condenser capacity is once again noted. The difference between these two capacities of the wavemeter condenser is equal to the capacity of the condenser being measured.

To obtain the inductance of a coil, disconnect the wavemeter coil from the terminals A and B, and in its place connect the unknown coil. Bring this coil into proximity with the three-circuit tuner and tune in a station whose wave-length is known. From this wave-length and the capacity of the wavemeter condenser, the inductance of the coil may be calculated by means of the following formula:

$$L = \left(\frac{\lambda}{1884} \right)^2 \times \frac{1}{C}$$

in which λ is the wave-length of the station being received in meters, L is the inductance of the coil being measured, and C is the capacity of the wavemeter condenser. In measuring the inductance of a coil, it is well to make the measurement of several wave-lengths as a check. The inductance will change with the wave-length, but will be found to change in a very orderly fashion, so that if the inductance be plotted against the wave-length, it will give a smooth curve of the shape shown in Fig. 5. This is contrary to what happens in the case of a condenser, for the capacity of a condenser is not changed with the wave-length.

Having obtained the calibration of the
(Continued on page 88)

The completed parts of the wavemeter showing the different coils used for various wave-length bands.

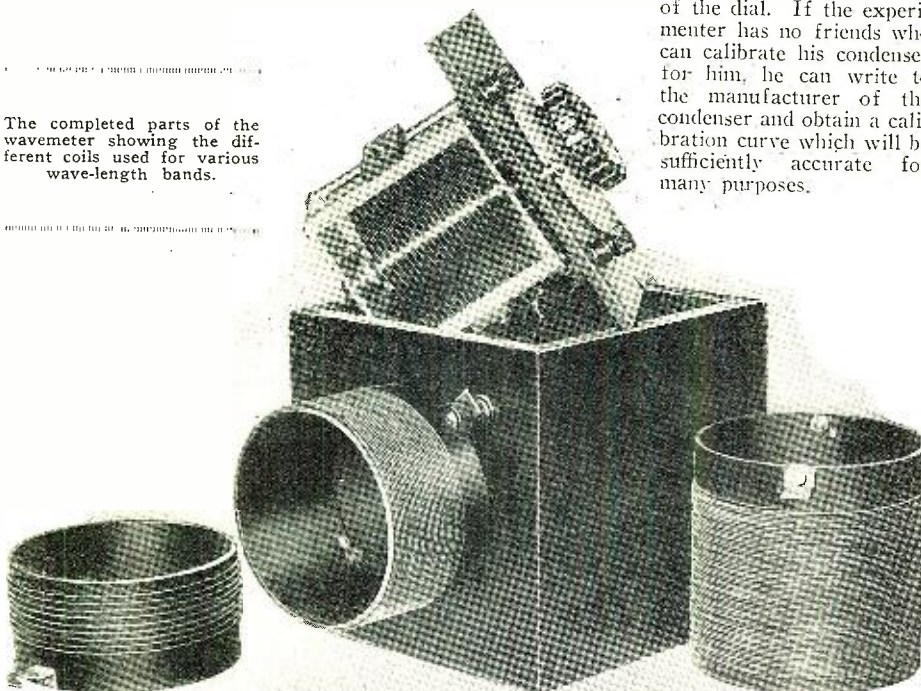

A Resistance Coupled Amplifier

By FRED A. PARSONS

For clarity and faithfulness of reproduction no audio amplifier equals the resistance coupled type. The description given here details the construction of such an amplifier which is both efficient and neat.

WITH the introduction of the new cone type loud speakers that are now on the market, it is more essential than ever to have nearly perfect amplification in audio frequency amplifiers over the entire voice frequency range, due to the faithful reproduction of this type of speaker. Many times it has been condemned because of the faculty of bringing out all that exists in the amplifier, particularly the distortion. It is the absence of this trouble in the resistance coupled amplifier that makes it ideal for perfect rendition. There are two outstanding objections to this form of amplification, however, namely, that a higher plate voltage than the usual 90 volts "B" battery must be carried to overcome the IR drop across the plate resistor, and more important the degree of amplification per stage is far

the exceedingly small plate current the IR drop at the plate resistance is low and 100 volts will be sufficient to give desired results. At this potential the plate current is .0005 amperes per tube in the first two stages, as the internal plate impedance of 100,000 ohms plus a similar value in the plate circuit resistor would, by the application of Ohm's law, give this current.

On account of the governing voltage drop across the filaments of the 102D tubes, these are connected in series through a six-ohm rheostat to the six-volt "A" battery supply, while the "E" tube in the third step is directly across the battery without a rheostat, the permissible drop at the filament of this type being 6.5 volts. In this circuit the current in the filaments of the 102D tubes is .750 amperes, any greater value permit-

ting more power being delivered in the output than the loud speaker can handle. In view of the small power in the plate circuits of the 102D tubes, an "E" type is used in the third stage, the maximum power available being to the order of five watts. Some figures showing the current values in the output circuit will be of interest here. The announcer of a 500-watt broadcasting station 20 miles away will cause the plate current in the "E" tube normally .004 amperes with a 9-volt negative bias, to swing to .019 or .020 amperes a controlled current of 15 or 16 milliamperes, or more than most speakers can faithfully use. The beauty of having this large amount of power is that the minute energy supplied to the input is passed undistorted through the three stages of the amplifier and delivered to the output with a volume more than sufficient, for ordinary purposes.

The values of the various resistances and coupling condensers are shown on the circuit diagram. The wiring can, in a resistance coupled amplifier, be made very simple if the apparatus is laid out in the progressive order as illustrated. As there is no problem of stray fields, as in a transformer amplifier, no howling or feed-back effects are present, and the amplifier remains perfectly quiet. There also seems to be a much smaller ratio of static and other extraneous disturbances to affect signal amplification.

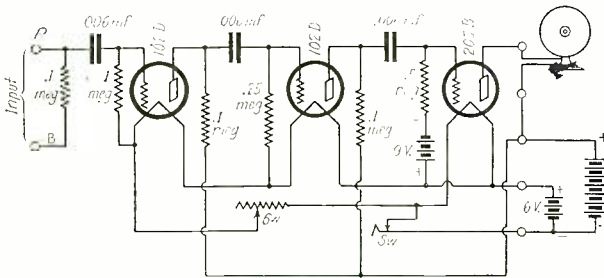

Left: Three-stage resistance coupled amplifier, that gives remarkable volume without distortion.

Below is a photograph of the completed unit. There is but one rheostat for the three tubes.

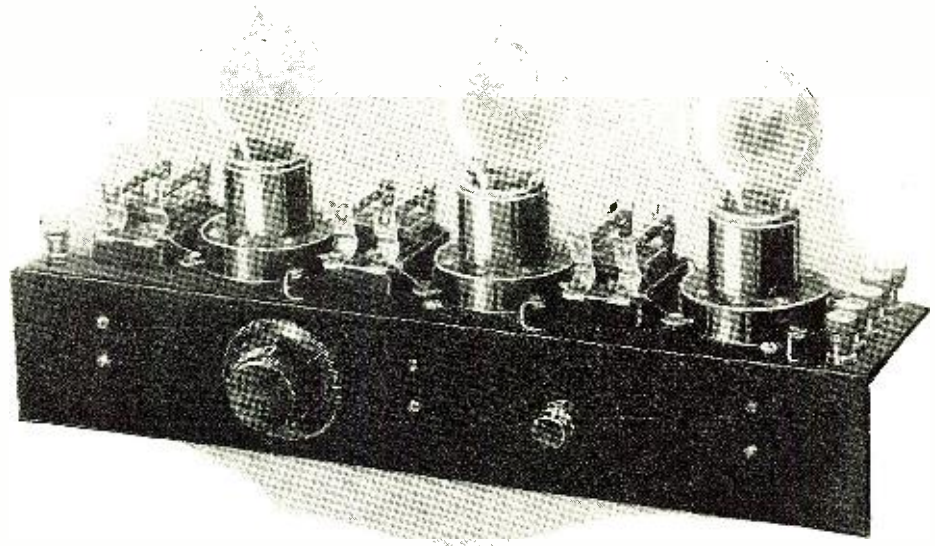

less, requiring three stages to simulate the gain in a two-step transformer coupled set. If the proper tubes can be procured, these objections can be overcome at once. In the amplifier outlined below, Western Electric 102D tubes were used in the first two steps and a 205B "E" tube in the third step.

The reason for the comparatively small gain or amplification per stage in the resistance coupled unit is that the voltage amplification is limited to somewhat less than the voltage amplification factor of the tube (type 201A, 301A), which is normally about 6. With the use of transformers, however, the step-up ratio of the windings is a big factor in determining voltage to be impressed on the grid of the succeeding tube. To explain that the amplification factor of a 102D tube is 30 will indicate quite obviously why it is ideal in the resistance coupled amplifier. The characteristics of this tube are as follows: Filament current, .950 amperes; filament voltage, 2; plate current, .0005 amperes; plate voltage, 120; amplification factor, 30; plate impedance 100,000 ohms, and the power output, .0045 watts. By virtue of

Receiving On A Loop Antenna

MANY times the writer has been approached by a novice in radio with the question, "Will it be necessary for me to rig up one of those outside affairs on my roof? Can't I use an indoor aerial?"

Forthwith, when the writer attempts to make answer in the simplest fashion possible, the newly-born bug gets all mixed up. The practical answer to the question, however, is very simple. It is somewhat as follows:

The receptive power of a loop antenna of the ordinary form can no more be compared with that of a large outdoor antenna than a

small tugboat can be compared with a battleship. But if the tugboat is made as large as a battleship, its power becomes comparable with that of the floating fort.

So it is with the loop and the aerial. The receptive power of a small loop is exceedingly small compared with that of the regular antenna. If, however, the loop be made of dimensions comparable with those of the aerial, its receptive qualities are pretty nearly equal to those of the aerial.

The small loop antenna can only be used when there is sufficient amplification, in the form of radio frequency amplifiers, to make

up for the great diminution in receptive power. The amplification furnished by an ordinary three-circuit tuner is not generally sufficient for ordinary purposes. A well designed three-circuit tuner, however, can be made to operate a loud speaker satisfactorily on local concerts.

To do any better than this requires at least one stage of radio frequency amplification before the detector tube. Considerably better results can, of course, be obtained if two stages are used, as is the case in the Neutrodyne and many of the five-tube sets now on the market.



Your Radio Set and Your Vacation

By A. P. PECK



THROUGH the long winter evenings of the past season you have enjoyed to the full all of the benefits of good radio reception. Cold weather, for many reasons, is the very best time of the year for this work.

During this time you are less bothered with static or atmospheric electricity than any other time of the year and greater DX reception is possible. However, just because summer time is coming along with its attendant static, do not for one moment believe that you must give up your fascinating hobby. Even though the occasional crashes of static in the phones or loud speaker are quite bothersome, still the local stations are putting on good programs and can usually be brought in loud enough so that the static is not so bad. It is only when a weak local station is being received that static troubles the operator.

There is no doubt, however, but that you must give up distance reception for the summer and content yourself with the programs offered by the local stations. And so, since radio broadcasting stations are liberally distributed over the entire United States, you will always be close to one or more of them even though you may go on a vacation trip out in the wilds. Here, more than ever, you will desire your radio set, so as to keep in touch with the events of the world and so as to aid in passing the long evening hours. Therefore, when you start to make the plans for your vacation, be sure to include in them the fact that your radio set is going to be one of your accessories.

TYPE OF PORABLE SETS

We have illustrated in Figs. 1 to 4 inclusive four types of compact, self-contained



Fig. 2. A two-tube portable receiver using dry-cell vacuum tubes and incorporating a loud speaker in the carrying case. The batteries are contained within the cabinet and the entire unit lends itself very well to the requirements of the vacationist.

radio receiving sets which are well adapted to the use of the traveler, whether he be contemplating an automobile tour, travel by train, boating, or a walking trip. There is a set designed for each and every one of these purposes. Of course, besides those sets illustrated there are many others, all of which have some good and some bad features. There are also the various home-made portable sets described in this and other publications which will give excellent results. Any set of this nature, it must be remembered, will be subjected to various uses that the average set was never made for. The case must be strong so as to withstand hard knocks. The entire set must be inclosed within this cabinet so that there are no projecting knobs, dials or pointers which may catch on other equipment, and last but by no means least, the entire unit should be self-contained and equipped with a suitable handle for carrying. The self-



Fig. 4. A five-tube self-contained portable receiver designed to operate on a loop. The loop is of the folding type shown.

contained feature is important. All of the batteries, both "A" and "B," should be inclosed within the case. Therefore, we will figure upon the use of sets incorporating tubes which operate from dry cells. For short trips, the entire weight of the radio set can be reduced still further by choosing vacuum tubes of the UV-199 type which can be operated for a short time upon two or three three-cell flashlight batteries connected in parallel. These batteries will weigh far less than three standard dry cells, such as are usually used on these tubes and will give fairly long service.

VACATION SET DE LUXE

Let us refer specifically to the four sets illustrated herewith. In Fig. 1 a six-tube set is shown, designed to operate on a loop antenna. The loop is incorporated in the cover of the cabinet as shown, and may be

mounted in a rotatable position so as to be ready for instant use. The set is shown with the loop in position so as to be ready for instant use and with the folding loud speaker horn opened. This is located at the left end of the carrying case. The six tubes and their attendant batteries can be seen mounted in their respective positions. A loud speaking phone unit is placed in the rear of the folding horn or sound chamber and is connected to the set in the usual manner. With this set only one tuning control is used. This is the dial shown in the lower right-hand corner of the cabinet. One rheostat controls all six tubes and a potentiometer is used to keep the circuit in stable operation.

In Fig. 2 is shown a two-tube portable set using two 1½-volt vacuum tubes in a reflex circuit. The tuning controls are situated on a small panel at the left and a small loud speaker horn is placed in the bottom of the cabinet, with an opening in the front which can be covered by means of the flap shown. This set gives excellent results used with an outside aerial such as the one described further on in this article.

Fig. 3 illustrates a portable set put out by a prominent manufacturer which does not incorporate a loud speaker in the cabinet. One or more pair of phones may be carried and plugged into the jacks provided for that purpose. A cover, not shown in the photograph, is supplied with this set, so that the control panel may be completely protected when the set is being transported.

A five-tube set using a reflex circuit and entirely self-contained is shown in Fig. 4. The right-hand compartment in the lower part of the carrying case houses a loud speaker, while the batteries are placed in the left-hand compartment. An ingenious folding loop is to be used with this set and when unfolded and placed in operating position is to be plugged into the jack provided for that purpose, whereupon it may be rotated into the desired position. Here again only a single wave-length control is used, located at the left-hand end of the panel. The other large dial on the panel plays an important part in keeping the set in constant and stable operation and preventing distortion. With the two compartment doors closed and the cover locked in position, this



Another type of portable receiver, not described in the text, which is of standard manufacture and gives excellent results.

set presents a neat appearance and can be safely and easily transported.

CARE OF TUBES

This is an important point that is often overlooked by the user of portable radio sets. The filaments in the dry cell tubes are extremely fragile, particularly in the UV-199 type. Therefore, the tubes require great care when being carried from place to place, especially when carried in an automobile. They should not be left in the sockets, but should be removed, wrapped in the usual packing that accompanies new tubes and placed in the standard cartons. They may then be carried in a separate package from the radio set or if there is room in that unit, they may be placed in it. The packing protects the tubes from vibrations and sudden jars which otherwise might break the extremely thin filament wire and render the tube useless.

Everyone contemplating a summer tour in an automobile can certainly take along a radio receiving set. The automobile offers great advantages to the radio fan, inasmuch as the size of the set does not have to play such an important part and various accessories can be safely and conveniently stowed away in the baggage compartment. A further advantage of the automobile is that no "A" battery need be carried. Standard six-volt tubes may be used and when the automobile is stopped and the radio set put into operation, two flexible wires may be led from the "A" battery binding posts on the set to the automobile battery. This will not have any detrimental effect on the latter as a comparatively small amount of current is used in the operation of a radio set. Furthermore, in the automobile, 100 feet or so of wire, a similar length of light rope, a weight and two insulators may be easily carried, to be used for the aerial described below.



Fig. 5. How the tourist may set up his radio receiving set. The car battery supplies the "A" current for the tubes and a tree supports the single-wire antenna.

SETTING UP THE PORTABLE RECEIVER

When touring with an ordinary portable receiving set using a large antenna, the procedure to follow when arriving at your destination or at some point where you are going to stop for a while to use your receiving set is as follows: Place the set on some level spot, either in or outside of the car, and if the batteries are not contained in the cabinet and already connected to the set, make the necessary connections. Now drive a short iron rod which you have brought along for that purpose into the ground, preferably in a rather moist spot. To this rod should be fastened a length of flexible wire by means of a standard ground clamp such as you use on your home set. The iron rod need not be longer than two feet and should be sharply pointed at one end for convenience. The other end of the wire fastened to the rod should then be con-

nected to the ground binding post of the receiver.

The next thing to claim your attention will be the aerial. Tie a stone or other small weight on the end of the light rope which you have provided and toss this weight over a limb of a nearby tree. Fasten an insulator on the end of this rope and the aerial wire to the other end of the insulator. Then proceed to pull the aerial up till the insulator is near the limb, but be careful to see that the wire itself does not touch any of the foliage of the tree. The rope can be wrapped once or twice around the trunk of the tree and secured. The other end of the aerial is provided with an insulator and a short piece of rope or wire which, in turn, is fastened to a stake driven into the ground. This may be either wood or iron, and if the former is used it can be easily found on the spot. It is a wise idea, however, to carry a stake along for this purpose. The aerial can then be connected to the set by means of a short length of flexible wire. The entire layout is completely illustrated in Fig. 5; all of this equipment necessary can be stowed in a very small space. The wise tourist will provide a small bag or box for stowing away this material, so that it can be quickly found when needed and no time lost in setting up the receiver.

THE HIKER'S SET

The hiker who must depend upon only that material which he can carry on his back faces a somewhat more difficult problem. His material must be light in weight and the parts must be few in number, otherwise the radio set will become a burden before many miles are covered. Several compact radio receiving sets employing one vacuum tube are on sale today and the small flashlight batteries mentioned above may be used to heat the filament of the UV-199. Also sets of this nature can be made at home very cheaply and your own particular ideas and designs followed. The aerial used can be of the type mentioned above in connection with automobile touring, or if still more space must be conserved, the little known but very practical "tree-aerial" shown in Fig. 6 may be used. This merely consists of driving two fairly large spikes into a convenient tree in the position shown. One of them should be 15 to 20 feet from the ground and the other about one foot from the ground. Short lengths of wire then connect these two spikes to the set. The upper spike is connected to the aerial binding post and the lower one to the ground post. With this aerial and a fairly sensitive set, local stations come in very well. It would be well to experiment with your particular type of set on some tree near your home before venturing out into the woods, so that you will know just exactly what you may expect of your set when in camp.

The third means of transportation that we will consider is the boat. Aerials on motor

boats are common today and need little explanation. A short mast in the center of the boat will support the center of an aerial, the ends of which may be attached fore and aft. The same procedure can be followed in rowboats and canoes on a smaller scale, although in general for marine use, a good portable set employing a loop aerial such as those illustrated herewith will be found superior to others. Since weight need not be considered except to a very small degree, this type of set is to be recommended.

A few words in regard to the general care of radio sets on camping or touring trips will not be amiss. Of course, they should never be submitted to rough usage and should be protected in every manner possible. Even the outside of the carrying case of a radio set should not be exposed to rain

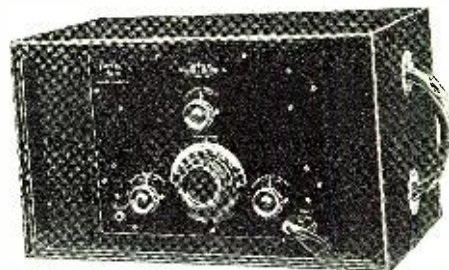

Fig. 3. A standard type of portable set with which a cover, not shown, is supplied. This receiver is of the single-control type and is exceedingly easy to tune.

or heavy moisture. If it is thought that such conditions will be met, it will be a very good idea to provide a rubber covering for the entire set, which may be placed over it and secured in position, thereby preventing any possible damage through exposure to moisture.

Since the writer's article in the June issue of this magazine was written the set illustrated in Fig. 8 in that article has been subjected to further tests. It has been found that broadcasting stations within a radius of 1000 miles can be brought in on the loud speaker with excellent volume and good reproduction. This is most unusual for a two-tube set and speaks well for the manufacturer's methods and materials.

40 Non-Technical Radio Articles

every month for the beginner, the layman and those who like radio from the non-technical side.

SCIENCE & INVENTION, which can be bought at any newsstand, contains the largest and most interesting section of radio articles of any non-radio magazine in existence.

Plenty of "How To Make It" radio articles and plenty of simplified hook-ups for the layman and experimenter. The radio section of SCIENCE & INVENTION is so good that many RADIO NEWS readers buy it solely for this feature.

List of Radio Articles Appearing in the July Issue of "Science and Invention"

- Radio Pictures From Hawaii to New York. WRNY, New York's Latest Broadcaster. The Radio Constructor—Most Complete Constructional Article Ever Published. By A. P. Peck, Assoc. I. R. E.
- Radio Synchronization Over 40 Miles.
- Three-Circuit Tuner with Push-Pull Amplifier. By Sydney E. Finkelstein, Assoc. I. R. E.
- A Page for the Novice.
- Radio Oracle, Radio Questions Answered.
- Radio Wrinkles.

Fig. 1. A six-tube portable de luxe for the traveler or motorist.

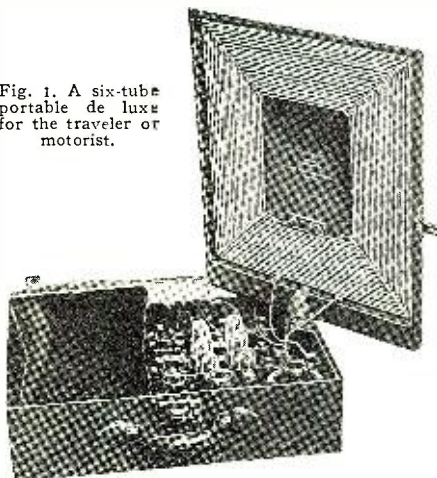

"Circuitgrams" Broadcast By WRNY

By HUGO GERNSBACK

For the first time in radio history complete radio circuits are now actually broadcast by means of a new system outlined here.

THE writer presents herewith somewhat of a novelty, in connection with the broadcast station operated by the owners of this magazine. The new station WRNY, located at the Roosevelt Hotel, New York, and operating on a wavelength of 258.5 meters, will broadcast the new radio circuitgrams once a week, on Mondays at 9 P. M., commencing June 22. This will be a regular weekly feature, which should soon become popular in the radio fraternity.

The writer, who has originated the circuitgram, on which patents are pending, has kept in mind the fact that the radio fans are always on the look-out for the latest radio hook-up. New hook-ups are originated almost every week, and it is the purpose of WRNY to broadcast these the moment they make their appearance.

The method of broadcasting any and all circuitgram hook-ups is extremely simple. The WRNY announcer will first state what sort of hook-up it is, whether it is a regenerative, a reflex, a super-heterodyne circuit, or what not. He will then advise that you use circuitgram blank 1, 2, 3, 4 or 5—whichever is best suited for the occasion.

Suppose the hook-up of a single-tube, tuned radio frequency reflex circuit is to be broadcast. The announcer will then speak as follows:

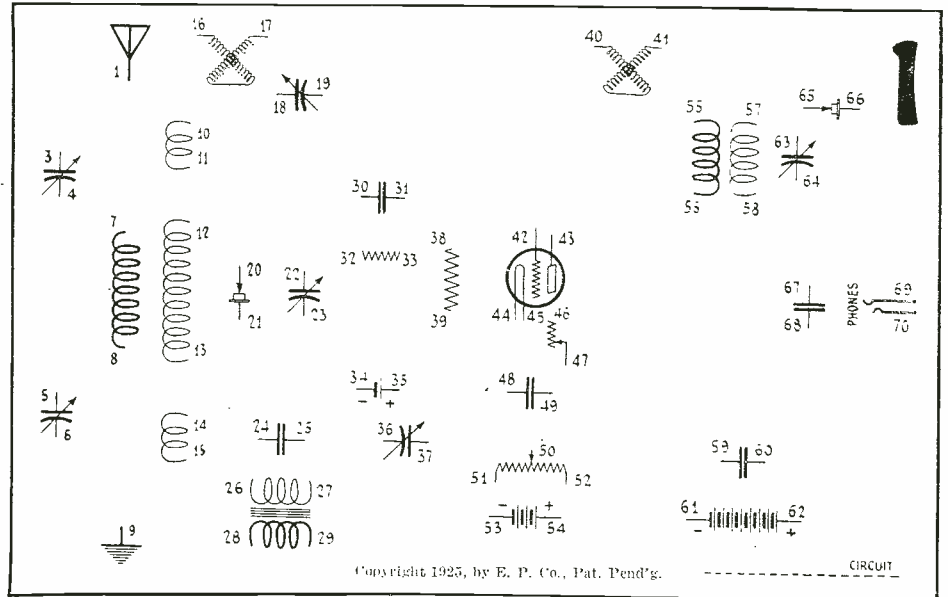

...tion numbers as follows: "Connect 1-7, 8-9, 12-42, 13-23, 22-12, 13-28, 9-29, 8-47, 44-54, 45-46, 47-53, 26-64, 27-66, 43-55, 56-69, 57-63, 63-65, 58-64, 70-62, 61-54."

and make sure that you have copied all numbers correctly.

If any special information is needed, as, for instance, in the completed hook-up shown

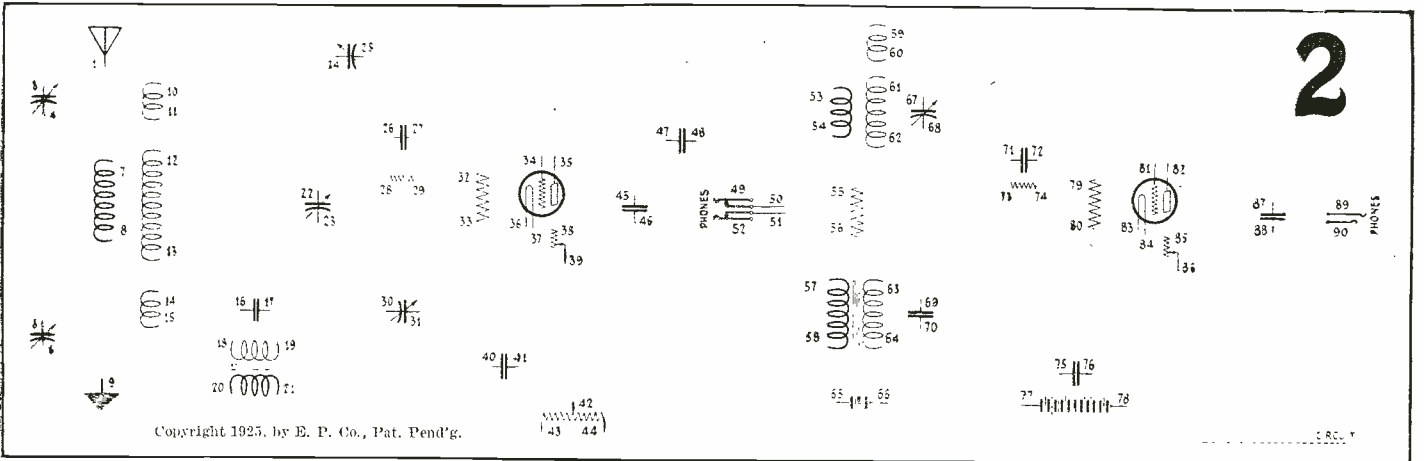

"We shall now broadcast a tuned radio frequency reflex hook-up. Please refer to circuitgram No. 1, single tube."

The announcer will then read off the con-

As he slowly reads these numbers, all you have to do is take them down. After reading off all numbers, the announcer will repeat them, so you can go over your record

in Fig. 6, the announcer will give such information immediately after the numbers have been read. Thus, for instance, he will give the number of turns and size of wire

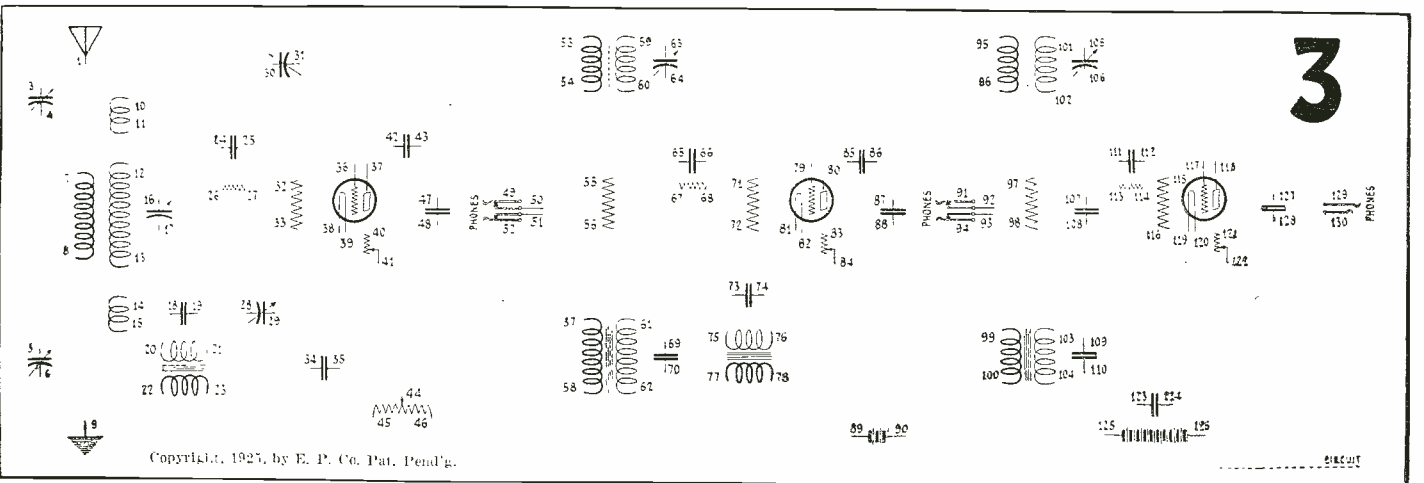

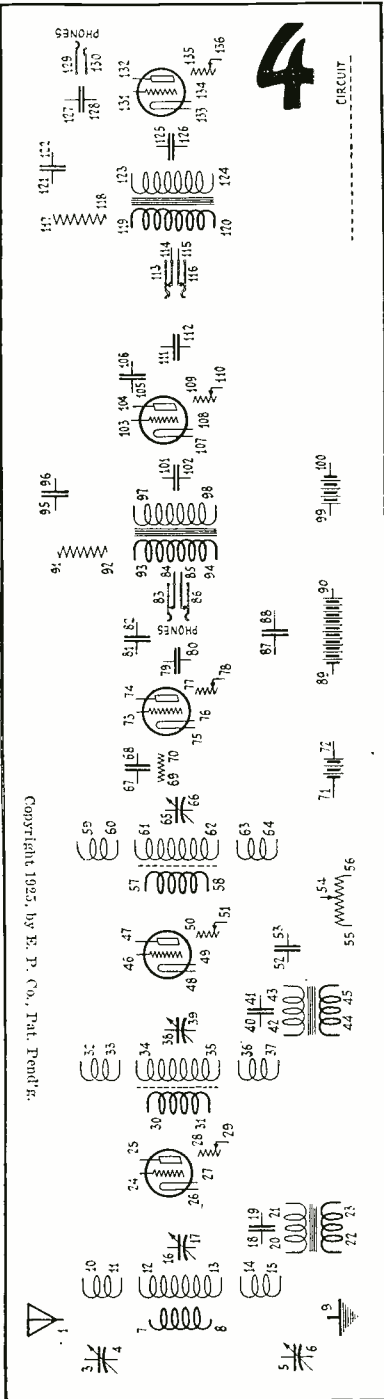

of coils 7-8 and 12-13; the ratio of transformer 26-27, 28-29; what crystal to use in 65-66; and all other necessary information.

And that is all there is to it. After the announcer has finished, all you have to do is take your record with the key numbers and fill in the lines on the circuitgram. You will then have a complete hook-up, as shown in Fig. 6. This is simplicity itself, and provides not only a lot of entertainment, but useful instruction as well.

It will be noted that the blank circuitgrams shown on these pages have been laid out in such a manner that it is possible to broadcast any modern hook-up, no matter what circuit is used.

Thus, for instance, it will be seen that the one-tube hook-up circuitgram provides for any possible circuit that could be used, such as detector, regeneration, reflex, radio frequency or for any combination of these employing a single tube.

As will be noted from illustration No. 6 the instruments that are not used in any particular hook-up are simply left unconnected. For this reason, even though the reader does not listen in to WRNY in order to take advantage of new hook-ups that are being broadcast, he can now draw his own hook-ups on the circuitgrams, without the necessity of first drawing the usual radio symbols.

It is interesting to note that it takes only two minutes to broadcast a hook-up of the type shown in Fig. 6.

The publishers of this magazine have prepared a tablet with blank circuitgram forms similar to those illustrated here, containing a goodly quantity of blanks. They will be furnished at 25c per tablet, sent postpaid.

The author would very much like to hear from our readers as to how they like this new feature, and any suggestions and improvements will be very gratefully received.

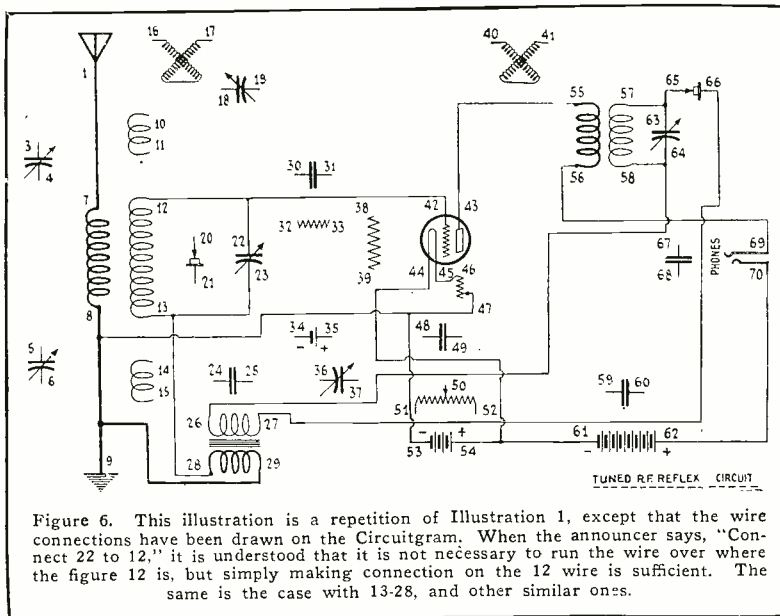
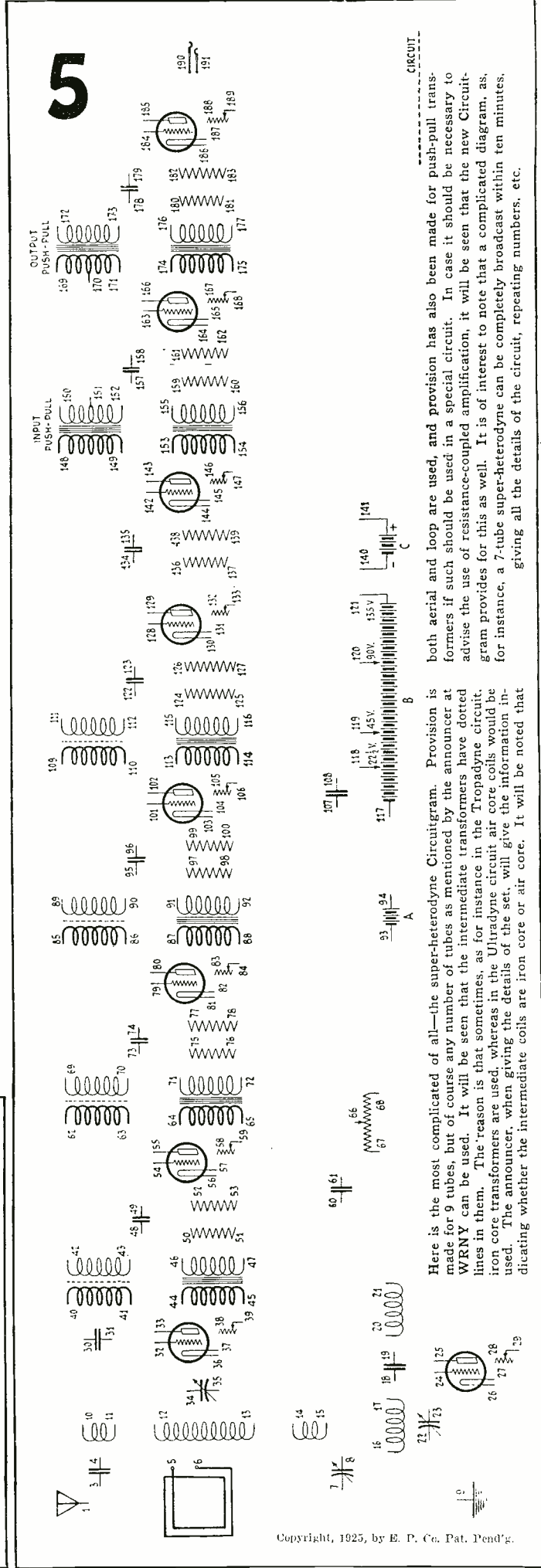

Figure 6. This illustration is a repetition of Illustration 1, except that the wire connections have been drawn on the Circuitgram. When the announcer says, "Connect 22 to 12," it is understood that it is not necessary to run the wire over where the figure 12 is, but simply making connection on the 12 wire is sufficient. The same is the case with 13-28, and other similar ones.



both aerial and loop are used, and provision has also been made for push-pull transformers if such should be used in a special circuit. In case it should be necessary to advise the use of resistance-coupled amplification, it will be seen that the new Circuitgram provides for this as well. It is of interest to note that a complicated diagram, as for instance, a 7-tube super-heterodyne can be completely broadcast within ten minutes, giving all the details of the circuit, repeating numbers, etc.

Here is the most complicated of all—the super-heterodyne Circuitgram. Provision is made for 9 tubes, but of course any number of tubes as mentioned by the announcer at WRNY can be used. It will be seen that the intermediate transformers have dotted lines in them. The reason is that sometimes, as for instance in the Tropadyne circuit, iron core transformers are used, whereas in the Ultradyne circuit air core coils would be used. The announcer, when giving the details of the set, will give the information indicating whether the intermediate coils are iron core or air core. It will be noted that



Wanted—A New Thrill

By Jay Hollander

The idea struck in this Hamitorial is, to our notion at least, one which is of very great importance. Maybe, as Mr. Hollander implies, the constant reach further and further will make us better scientists and not so much brass-pounders.

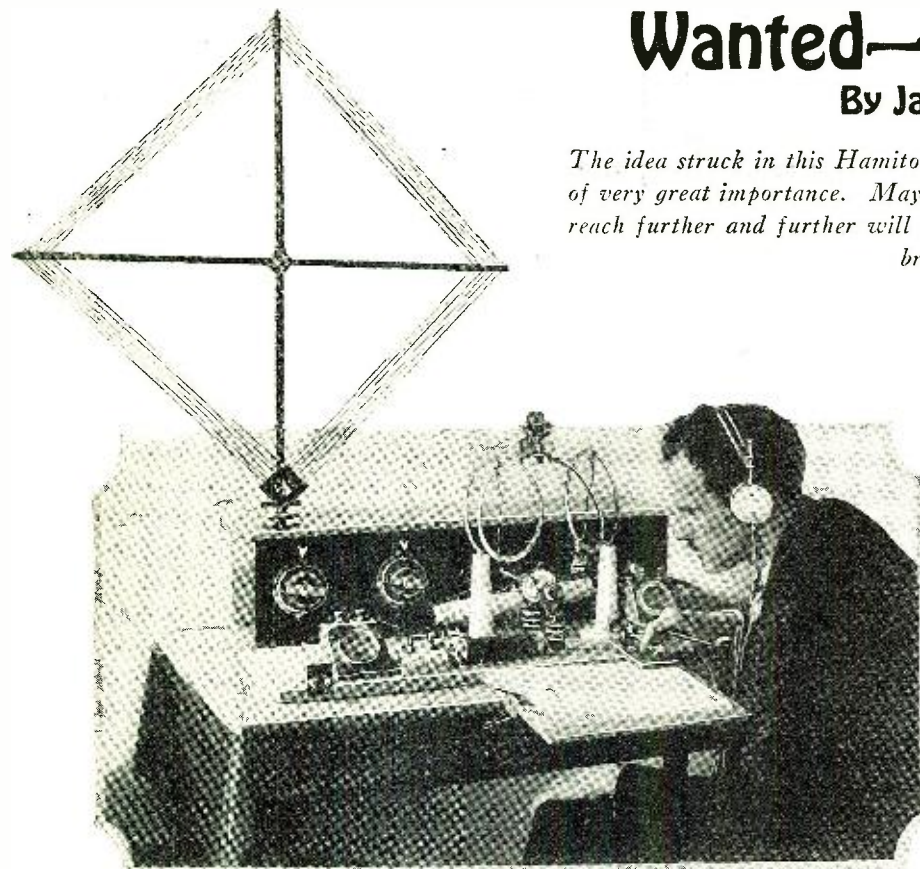

When we get DX until there is no more available because of exhausted supply, we will, like the experimenter above, turn to exploration of technical problems rather than the collection of cards.

WHAT strange tales do these messengers bring! None other than that the hams in their customary rôle have just about exhausted the possibilities of the old transmitter and receiver from the point of DX. Now that fifty watts as often as not is heard in New Zealand and India, some of the possibilities have been exhausted. We say some of them advisedly, since the great majority of the amateur brass-pounders have, since the discovery of the oscillating vacuum tube and its adaptation to the transmission of radio signals, cultivated a sort of fixed attitude to their particular brand of work.

With the stabilization of the methods practicable, their work has been constantly toward the annexing of cards from across the water. Any ham station picture of the present day which does not boast several of the cards written in foreign languages is hardly glanced at. The "calls heard" lists published in the various magazines have deleted district after district, with the notation: "Too numerous to mention."

And the funny part of it is that many of the erstwhile most enthusiastic hams have begun to lose their taste for the old game.

Why? It's simple. For the last three or four years they have been dependent upon reaching out another mile for the necessary thrill to keep them at the brass into the wee small hours of the morning. But they

are gradually defeating themselves because they are annihilating all possibility of DX by working clean around the world—at least, around the world in the radio sense, which means in mathematical terms, half-way around, *i. e.*, being heard in the Antipodes.

As soon as a New York City ham has been heard in India, he has about exhausted his possibilities, so far as transmission is concerned.

This is exactly the case with at least one ham we know. Recently he blew down to the shack one evening during the quiet hours and handed me a blow from which I shall not recover very soon. He turned the dials on the stand-by, brought in a local broadcaster who was handing out some hot jazz, and left the station in for more than an hour—until the jazz band which was furnishing the entertainment gave way to some lusty opera singer.

At the conclusion of the program, he turned on me as I was about to listen for the doings in the sixth and seventh, and said with a snarl in his voice: "I'm bored with radio."

Now I have known him for some years and have watched him build set after set—have even helped him through three or four near-divorces, induced by his inability to remember to buy theatre tickets or bring home the new vacuum cleaner his wife had ordered, because he was invariably wrapped

up in some new kink he contemplated installing in his set. Well—I was so shocked that I simply sat and stared.

Since I am of a philosophical turn of mind, the main point to me was: why was 2B—disgusted with his hobby which had served so well and so long?

The answer is a simple one. He was the gent that had been heard a couple of times in India. There was nothing more for him to work at. He had been in relays, had worked the coast among the first, been heard in every district here and worked them all, been heard in every civilized country where amateur radio is recognized, worked two-way communication across the Atlantic and now has been heard in the Antipodes. What was the use of continuing radio? Really, there wasn't any!

The whole advantage of radio as a hobby—any hobby, for that matter—lies in the possibilities it hands the ordinary man to release himself from the drudgery of everyday life. During the day, the radio ham goes to work just like any other individual. He usually takes his orders from a superior officer in the firm which makes out his weekly pay check, he is a part of a great organization, just a cog in a machine in which, possibly, he is not so important but that his place could probably be as well filled by someone else.

But at night, when his work at office or factory is completed for the time being, the ham goes to the shack and, for a little while, is a man of superior quality, a first-rater who is doing something for the advancement of the world; he is a scientific investigator who is striking maiden trails through the sylvan maze of natural phenomena; he is conquering new fields.

That is the kick which radio brings. Now suppose that all the possibilities are exhausted. What is the result? Immediately radio becomes a thing similar to all the little daily occupations so well known to the ham as to be nothing out of the ordinary. Consequently, he loses interest in the whole affair.

But here is the technicality which saves the defendant. For the greater part of the last couple of years—or rather the last five—since the inception and perfection of the vacuum tube transmitter and its attendant possibilities of great distance at low power, the thrill of plodding new roads, virgin roads, discovering new fields and, in a word, doing original work, has been gained principally through the traversing of great distances. And, as usual, when the ham starts something, he is never satisfied until he has reached the practical ultimate.

The ham in question whose boredom with radio in general was discussed earlier in this paper, had simply reached the ultimate in one direction. And here lies the technicality—he had failed to look about him for other possibilities along some other tack.

Now, me bucks, lean low and let me whisper a first-rate panacea into your stretching ears. To wit: the mere business of annexing crds. is, after all, a somewhat childish pastime at the transmitter. (That is, more properly speaking, it looks childish when one has covered the whole alphabet and has the shack well papered.) The ham should seek more pertinent fields where his great energy and ingenuity will produce something more valuable to future generations than mere wall-paper. Ergo, let him start some real scientific work.

In previous discourses from this pulpit we have stressed the importance of doing things up to a proper scientific brown with the proper garnishing of notes and curves. Investigations of all sorts are possible to him who has a few hours to spare and a couple of platinum contacts to pound. A couple of sheets of graph paper will often make a night's work at the key look like a paper from the Proceedings of the Institute of Radio Engineers, and perhaps its importance may merit a place in that turgid journal.

And the most important point in this connection is, of course, that it opens an entirely new field from which the ham, weary of collecting distance records, may turn his energies in order to keep up his morale at the office the following day and will perhaps lead him to some sort of place in the sun of the world's experimenters.

The advantage of this procedure as a thrill-getter is not to be minimized.

As a matter of fact, it holds a couple of barrels more thrills which may be on tap night after night than all the careful heterodyning of listening can bring.

And another point which must be stressed here again is that it is a pregnant gold mine. The smallest kink which can be worked into use in the ordinary receiver or transmitter may bring a young fortune to the gent who signs the first specification of it and receives the O. K. of a certain department at Washington, D. C. Why not make the pastime pay, as well as entertain?

And the moral of this tale is: Be a scientist first and an operator afterward, instead of vice versa.

The Month's Crop of New QRA's

8CJF—Elmer Knight, 209 Mt. Pleasant Ave., Barberton, Ohio.

8CTE—Jay Seymour, 116 Lake Ave., Elyria, Ohio. 5 watts CW. and fone. All QSL cards answered.

3MO—A. P. Peck, 32 Park Pl., North Plainfield, N. J. Pse QSL. All cards answered.

9AOG—Reassigned to Conrad Lunde, 227 Second Ave., North Crockston, Minn. All reports answered and appreciated. Pure D.C. CW. on about 185 meters.

6CWY—Amile Form, Box 79, St. Helena, Calif. 5 watts CW. and phone. Will QSL.

9BNV—Claude R. Baker, Britton, South Dakota. 5 watts AC—CW. All cards appreciated and answered.

8EQ—J. C. Lisk, 902 South Elizabeth St., Lima, Ohio.

8AOA—Ernest Dempster, 977 St. Johns Ave., Lima, Ohio. 10 watts. Reports appreciated. QSL cards.

8CQA—B. H. Mechling, 826½ South

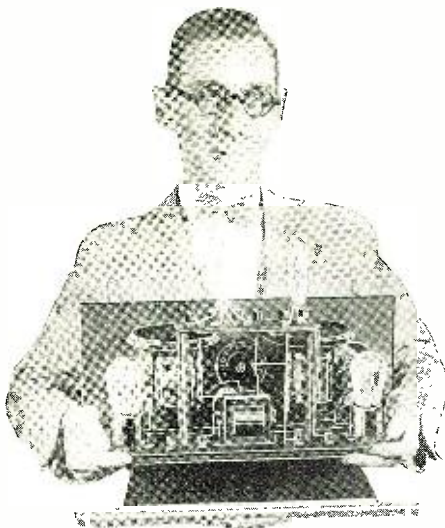

Lloyd Jaquet, American amateur, engaged in helping along the Entente Cordiale between the world's Hams. He's now in Paris following the International Ham Convention.

Main St., Lima, Ohio. Reports appreciated.

9CEY—Amos R. Utterback, 309 North Silver St., Olney, Ill. All reports appreciated as QSL always. Glad to QSR.

8WP—F. J. Hark, 67 Randolph St., Rochester, N. Y. 5 watts. All reports appreciated and answered.

8DTG—Henry H. Karpicke, 133 Wilkins St., Saginaw, Mich. Reports appreciated and acknowledged.

3LW—H. A. Robinson, Silver Lake Farm, Willow Grove, Pa.

9JW—A. C. Tomczak, 2649 Drake Ave., Chicago, Ill. 5 watts CW. and fone. Pse QSL is QRK? A card awaits every Rpt. Tnx.

Calls Heard

GEORGE S. SEVON, 2 AWAMUTER, WARKATO, N. Z.

U. S. A. CALLS HEARD: 6ab, 6ag, 6as, 6ar, 6aao, 6age, 6awt, 6afiu, 6avj, 6akw, 6adt, 6ahp, 6agk, 6arb, 6ame, 6abb, 6amm, 6auy, 6akz, 6amo, 6apw, 6afg, 6ase, 6aw, 6afj, 6aut, 6bk, 6bw, 6bjj, 6bcp, 6brf, 6bar, 6bur, 6bgr, 6bhm, 6baa, 6bbv, 6bql, 6buw, 6bga, 6bir, 6bip, 6bdo, 6bib, 6bra, 6bqb, 6cc, 6co, 6cq, 6cw, 6grw, 6cto, 6ceq, 6crx, 6cpz, 6cpo, 6cte, 6cum, 6czo, 6czx, 6cso, 6cet, 6cey, 6cxy, 6cgo, 6cti, 6cni, 6cft, 6cqc, 6cfs, 6cbb, 6ers, 6cdn, 6esw, 6cdt, 6cjo, 6emi, 6egg, 6cgk, 6eb, 6ff, 6fh, 6ig, 6gr, 6gg, 6ih, 6kur, 6lh, 6lj, 6mo, 6mnl, 6oa, 6or, 6oi, 6oil, 6pl, 6pw, 6qi, 6ru, 6rms, 6rs, 6tz, 6uy, 6ut, 6udd, 6vc, 6wt, 6xp, 6xab, 6zp, 6zh, 1ab, 1af, 1ak, 1ar, 1at, 1abr, 1cmp, 1mt, 1ow, 1pl, 1sw, 2age, 2bqh, 2bro, 2dn, 2lc, 2rk, 2xi, 3ot, 3tzo, 4br, 4cr, 4gw, 4io, 4tj, 4wn, 4mm, 4jy, 5akn, 5ab, 5alr, 5ba, 5cn, 5ckr, 5ew, 5ewa, 5jb, 5ka, 5ox, 5pb, 5qy, 5tak, 5ti, 5zal, 5zav, 7aim, 7alu, 7apo, 7ahi, 7dj, 7fd, 7fq, 7gb, 7gi, 7gq, 7ij, 7iw, 7ki, 7lr, 7ls, 7mf,

7nm, 7sf, 7io, 7wm, 7im, 7zwm, 8aul, 9at, 9acu, 9aqd, 9axo, 9bj, 9brt, 9bjj, 9bdw, 9bfy, 9boz, 9bcj, 9ca, 9ce, 9cfi, 9cjc, 9yjc, 9zd, 9zy.

SPECIAL: NKF, Wgh, KET, Kgi, 6xi, 6xo.
CANADIAN: 5B.A, 1D1J.
MEXICO: 1B, 1X, BX, LX.
SOUTH AMERICAN: cb8, db2.
ENGLISH: 201J.
ITALIAN: 1MT.
AUSTRALIAN: 3bb, 2aj, 2kh, 2yg, 2gq, 2ws, 2me, 2yi, 2oi, 2fc, 2hm, 2gm, 2xa, 2ui, 2jr, 2vs, 2rj, 2es, 2jt, 2cm, 2ds, 2ni, 2br, 2ij, 2kc, 2jm, 2lo, 2ay, 2cr, 2bl, 2as, 2gr, 2ij, 2ci, 2hk, 2zz, 3bd, 3cq, 3bq, 3cm, 3jh, 3bm, 3cf, 3hh, 3tm, 4an, 4cm, 5bg.

1CLZ, 127 DOVER RD., WEST HARTFORD, CONN.

U. S.: 1aao, 1aaw, 1abr, 1acj, 1acd, 1af, 1afd, 1ah, 1akd, 1aks, 1aue, 1ast, 1ate, 1atq, 1aty, 1aur, 1aux, 1av, 1awb, 1awg, 1axi, 1ayg, 1ayn, 1ayx, 1azh, 1bbe, 1bbk, 1bdx, 1bg, 1bhk, 1bq, 1bjf, 1brq, 1bs, 1hub, 1buq, 1bxh, 1bzp, 1ca, 1cak, 1cdi, 1chq, 1chl, 1chy, 1cna, 1coj, 1csy, 1csy, 1da, 1ga, 1hk, 1jm, 1kw, 1qb, 1qo, 1ri, 1uo, 1uz, 1yd, 2aa, 2acs, 2aco, 2acu, 2adu, 2adv, 2aek, 2aew, 2aey, 2afn, 2aig, 2agm, 2agq, 2agz, 2ahk, 2aic, 2anq, 2aph, 2ay, 2bc, 2bx, 2bur, 2buq, 2bw, 2cjj, 2cjk, 2cmk, 2crh, 2cvj, 2cxl, 2cxy, 2ha, 2hl, 2hl, 2ih, 2is, 2jl, 2js, 2kt, 2kg, 2kr, 2ky, 2ld, 2q, 2rk, 2xdf, 2ahk, 2ay, 3bl, 3bjp, 3ble, 3cb, 3cbv, 3cbx, 3cj, 3ds, 3hj, 3hk, 3io, 3kq, 3mk, 3na, 3op, 3pp, 3qt, 3rs, 3qt, 3rs, 3ut, 3wx, 3zo, 4bk, 4fj, 4fm, 4rn, 4sx, 4tw, 4vq, 4xx, 5ka, 6bur, 6cso, 6xad, 8ach, 8ack, 8acr, 8awq, 8avd, 8bd, 8bg, 8bu, 8hjj, 8hoi, 8hqv, 8hvx, 8hyv, 8ccn, 8cti, 8ek, 8eve, 8cyr, 8dkp, 9adg, 9aif, 9bf, 9bjz, 9hta, 9ckb, 9eku, 9cy, 9elb.

CANADA: 1ar, 1ch, 2ax, 2do. Glad to send a crd to any of the above who q-s. Qrk 1clz?

9APY, 3337 OAK PARK AVE., BERWYN, ILL. (MARCH)

1aa, 1ajc, 1asy, 1avl, 1axn, 1bkq, 1er, 1jt, 1om, 2agw, 2avg, 2uxq, 2bck, 2blp, 2hm, 2bq, 2br, 2by, 2bzj, 2ccl, 2cjj, 2cpa, 2czr, 2rk, 2wr, 3acc, 3blp, 3buu, 3boj, 3bss, 3bx, 3op, 4cp, 4dv, 4kl, 4og, 4rm, 4rw, 4tu, 5abc, 5ahr, 5ail, 5am, 5ame, 5amh, 5ana, 5aom, 5aqq, 5aqp, 5auc, 5aur, 5bw, 5cc, 5ce, 5co, 5in, 5jg, 5ka, 5lr, 5ls, 5mq, 5oq, 5ov, 5ph, 5rg, 5va, 5vv, 6ajj, 6bjv, 6gx, 7df, 7sl, 7si, 7sl, 8alf, 8aol, 8aol, 8ayv, 8boy, 8br, 8brb, 8ccs, 8cjb, 8cx, 8ob, 8sf.

CANADIAN: 3ck, 3nj, 3ph.
FONES: 3np, 3br.
MISCELLANEOUS: Ket, nkf, wgh.

A2CPX A2ZZ, C. PRESTON-SMITH, 83 CARAMATTA ROAD, CREMORNE, N. S. W., AUSTRALIA

One tube set used, low loss.
 1ack, 1ar, 1gx, 1or, 1cz, 1no, 1vc, 1vht, 2ag, 2awe, 2ft, 2rd, 2mq, 2rk, 2had, 3aan, 3ebk, 3abw, 4nu, 4ov, 4act, 4io, 4mi, 4cay, 4xe, 4sa, 5zal, 5ow, 5aux, 5akn, 5abg, 5aw, 5ta, 5ay, 5cah, 5ak, 5uc, 6jvu, 6bur, 6vc, 6emu, 6ego, 6cto, 6gw, 6cxg, 6ar, 6aao, 6bcp, 6ase, 6avt, 6akw, 6ka, 6ckr, 6ckp, 6ri, 6av, 6lkr, 6kt, 6aav, 6aos, 6uov, 6gv, 6avv, 6cop, 6vy, 6ede, 6lr, 6bv, 6jtb, 6mt, 6av, 6bw, 6auu, 6avt, 6ape, 6no, 6gn, 6aw, 6cc, 6gu, 6acu, 6abp, 6wqb, 6eke, 6bbe, 6ekt, 6edb, 6jy, 6hve, 6aan, 6utl, 6awi, 6awp, 6cp, 6avj, 6ug, 7ga, 7gd, 8hb, 8gz, 8bak, 8cp, 8cm, 8zz, 9ya, 9bte, 9hg, 9mc, 9zt, 9uek, 9cf, 9cl, 9ej.

CANADIAN: 5ba. All cards answered, and accurate dates, times, etc., furnished.

Am desirous of arranging schedule of tests. Any station who is willing to reciprocate, please drop me a line.

Will all stations who have heard my 5-watt C.W., when signing 2ZZ-A, and who have not already qsl'd, please do so?

Just had thousand cards printed, so don't be afraid!!

Station 9DHF, Galesburg, Ill. Two 50-watt punch the juice into the antenna through a four-coil Meissner arrangement. A five-watt fone pinches at local range. The receiver is low-loss and has 1 audio.

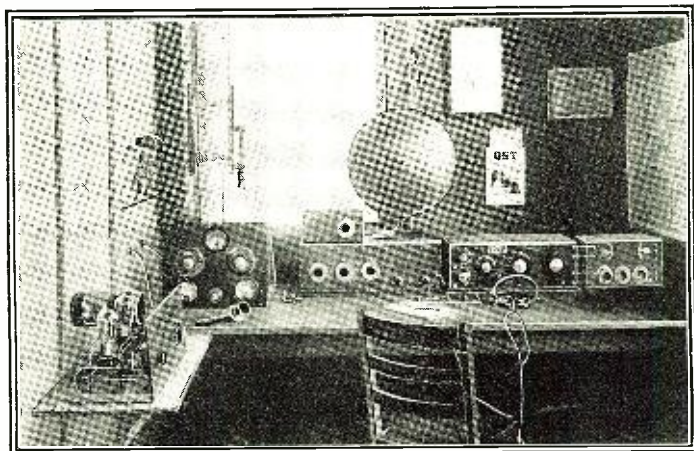

A Study of Reactance

By SYLVAN HARRIS

An interesting article on a fundamental unit of electrical measurement.

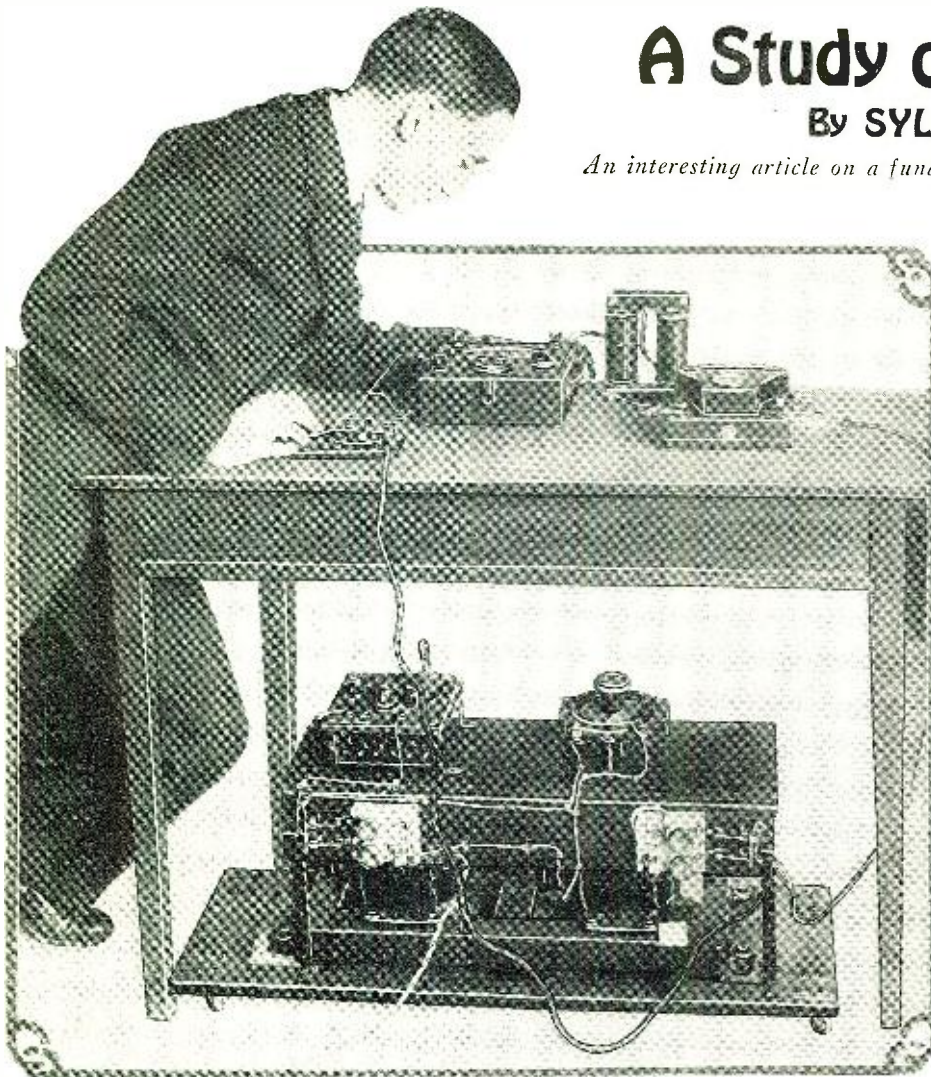

This shows how impedance is measured.

THE radio student has by this time probably become aware of the fact that there are many conceptions in electrical engineering and in radio with which it is necessary to familiarize himself, if he is desirous of obtaining a fair working knowledge of the subject. Many of these conceptions are simple, and involve no knowledge of mathematics higher than arithmetic, or at best, elementary algebra. For this reason there is no excuse for the ambitious radio fan who has not yet learned them. It is a great disadvantage to him to be ignorant of them, for the lack of this knowledge makes it more difficult to comprehend many of the phenomena, and also

more difficult for the radio writer to couch his expressions in terms that the uninitiated can easily understand.

One of the most important of these conceptions, and perhaps the most interesting, is that of *reactance* in alternating current circuits. Nearly all the phenomena found in radio circuits depends upon the reactances of the circuits, and many of the phenomena can be predicted or explained by a study of the reactances.

INDUCTANCE

We are all more or less familiar with the fact that the presence of inductance in a circuit tends to retard the flow of alternating current through it. Suppose we have a circuit as represented in Fig. 1, consisting of a battery, a key, and a large inductance coil hooked in series. When the key is open, there is, of course, no current flowing. But suppose we press the key, thus closing the circuit. At that instant the current begins to flow and, of course, has to jump from the zero value to some finite value. This is represented in Fig. 2A, where time is represented as the horizontal axis, and the current is shown on the vertical axis of the chart.

It takes an appreciable time for the current to reach its steady value, perhaps several thousandths of a second. This time can actually be measured with an oscillograph. The important point in this connection is that, during this very short interval, the current has been changing very rapidly in value. This rapid change is indicated by the steepness of the curve between the points o and b.

We are all aware of what happens when the current through an inductance coil

changes very rapidly. The magnetic field brought into existence by this current changes very rapidly, and consequently the self-induced electro-motive force generated between the terminals of the coil becomes very high. This is caused by the cutting back of magnetic lines of force on the turns of wire in the coil. The same thing happens whenever any magnetic field is cut by a wire or other conductor. The faster this magnetic flux is cut by the wire, the greater will be the induced emf. The effect is accentuated in a coil because the magnetic field is concentrated into a relatively small space, and the greater the number of turns, or the greater the inductance, the greater will be the effect.

It can be seen in Fig. 2A that the current through the coil is changing at its greatest rate just when the switch is closed—that is, at the point o, which represents zero time. The magnetic field in the coil is simultaneously varying at its greatest rate, so that the induced emf. will immediately jump to a rather high value. This is represented in Fig. 2B by the curve oc. As time goes on, and we approach the point b in Fig. 2A, the rate at which the current changes in value (and also the magnetic field) grows less and less, as indicated by the gradual sloping of the curve toward the horizontal. The voltage across the ends of the coil will simultaneously drop, as indicated in Fig. 2B, until it assumes a steady value. The steady values of current and voltage shown in these two figures are determined by Ohm's law, *viz.*, $I = E/R$, where I is the current in amperes, E is the emf. of the battery in volts, and R is the resistance of the coil in ohms.

THE EQUATION

The whole story can be told in very simple language by means of the following equation:

$$E = L \frac{di}{dt}$$

in which E is the self-induced voltage, L is the inductance of the coil, and di/dt is a mathematical symbol signifying the rate of change of the current i with respect to time. The interpretation of this is that the greater L or di/dt becomes, the greater will be the emf. When the rate of change of current becomes zero (*i. e.*, di/dt becomes zero), E is zero. When L is zero, E is also zero.

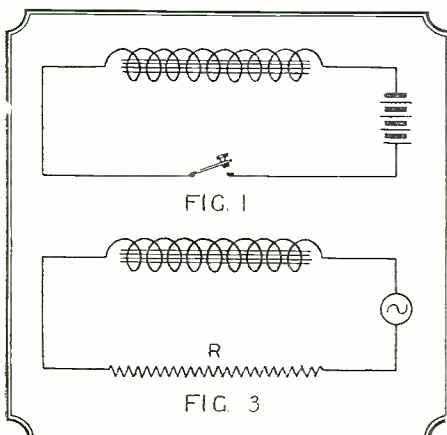

Fig. 1. A simple series circuit with high reactance.

Fig. 3. An A.C. circuit having resistance and reactance.

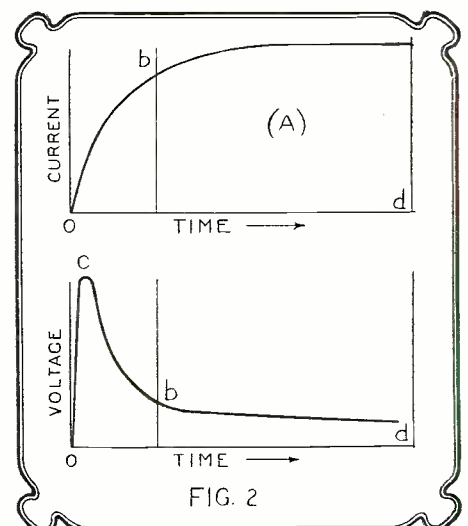

FIG. 2

How the current and voltage act as the key in Fig. 1 is pressed.

The voltage we have considered is not the battery voltage; it is the self-induced voltage in the coil. This may be many times the battery voltage, as can be proved by the fact that a heavy shock is often felt if the fingers are placed across the key when it is opened. This is explained in Fig. 2 at d,

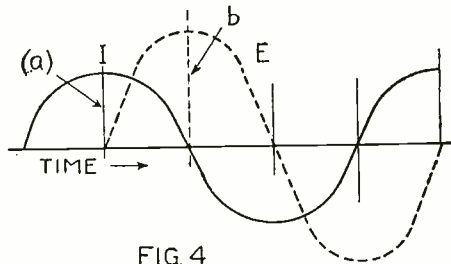
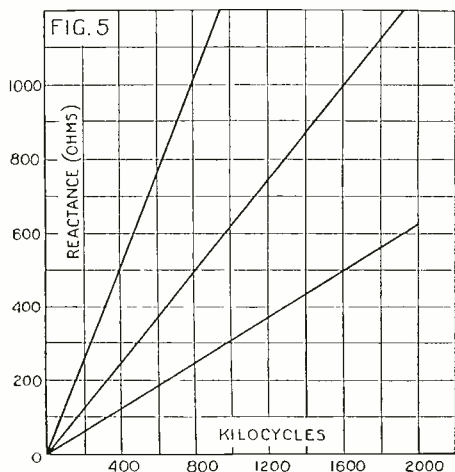

FIG. 4 shows the relation between current and voltage in an A.C. circuit.

where the circuit is broken by opening the key. The current instantly drops to zero (Fig. 2A) and the rate of change of the current (di/dt) is enormous, so that the voltage jumps to a sufficiently high value to create a shock, or even a spark.

By a study of these curves it can be seen that the current is not necessarily greatest when the voltage is greatest. In fact, the voltage may be greatest when the current is very small. This is indicated in Fig. 2A and B. The same thing is true in alternating current circuits, or radio circuits, in which the current and voltage change direction periodically. Suppose we have an alternating voltage impressed across the terminals of a coil of high inductance. This coil can be supposed in series with a resistance, as shown in Fig. 3. The current in the circuit is represented in Fig. 4 by the curve marked I, and the voltage by E. The self-inductance of the circuit causes the current to lag behind the voltage, so that the instant of maximum current follows some time after the instant of maximum voltage.

The slope of the current curve I changes most slowly at the rounded portions at the top and bottom. The slope changes most rapidly near the zero values, where the curve crosses the line. These slopes indicate the rate at which the current is changing, so



This diagram shows how inductive reactance varies with frequency. The curves are for 200, 100 and 50 microhenries, upper to lower curves.

that, as we should expect from what has gone before, the induced voltage is zero when the current is not changing value, as at a, Fig. 4, and is maximum when the current is changing most rapidly, as at b, Fig. 4.

Fig. 4 also shows another interesting point, that is, that there may often be such a condition that there is no power being expended in a circuit, even if there is a large current flowing. For, taking the conditions at the instant marked a in Fig. 4, the current has

a large value, say I' , and the voltage has the value of zero. The power expended in a circuit is the product of the voltage and current, and in this case

$$P = E \times I = 0 \times I' = 0$$

At other instants during the cycle, however, the power expended may be considerable. Most of this power goes into the magnetic field of the coil. Only a small amount is lost in the resistance in the circuit, providing this resistance is not excessively high.

MAGNETIC POWER

Whatever power is put into the magnetic field is returned to the circuit when the field either collapses by having the current cease flowing, or by having it reversed, as happens in alternating current circuits. As the field collapses, the lines of force cut back on the turns of the coil and induce emf.'s in them which are in a direction opposed to the original emf.'s induced when the field was set up. We must remember that all this happens in accordance with Lenz's law, that is, whatever kind of action is set up in a circuit, there is always an opposing action set up at the same time. When we try to make

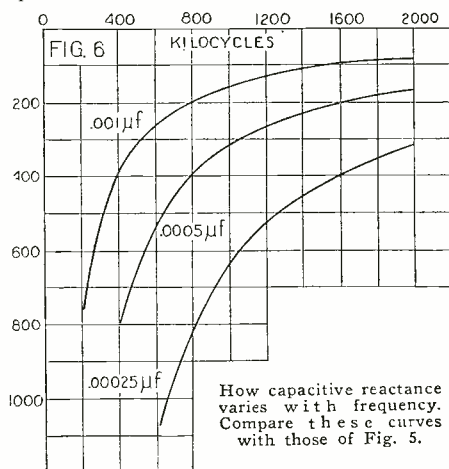

How capacitive reactance varies with frequency. Compare these curves with those of Fig. 5.

a current flow in an inductive circuit, the inductance tries to retard the establishment of the current; when we try to stop the current, the inductance tries to make it continue. This is the cause of the spark described in connection with Fig. 1.

Since the two effects noticed when making or breaking the circuit, or when the current first flows in one direction and then in the other, are in opposite senses, the net effect on the circuit is nil; the actual power expended is therefore zero, as explained above, and the product of the current and voltage is spoken of as the "wattless power."

All this does have an effect on the current and voltage values in the circuit, however, and there is a certain relation existing between these, just as there is a certain relation existing between current and voltage in a circuit when considering the resistance. The ratio between the voltage and current

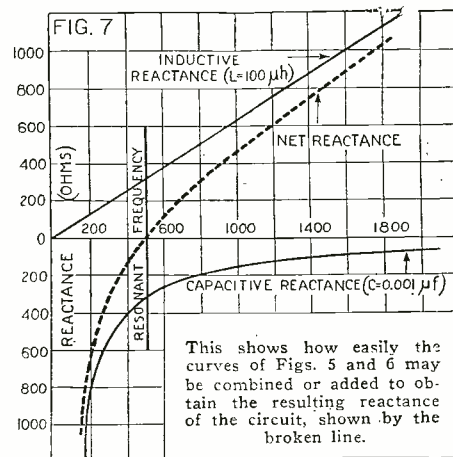

This shows how easily the curves of Figs. 5 and 6 may be combined or added to obtain the resulting reactance of the circuit, shown by the broken line.

in a circuit containing resistance is the resistance itself, or:

$$V/I = R,$$

whereas the ratio between the induced emf. and the current in an alternating current circuit is the reactance, or:

$$E/I = X.$$

The reactance may be due to either inductive or capacitive effects. The inductive effects have been explained above. The capacitive effects are just the opposite; capacity in a circuit causes the current to lead the voltage, whereas inductance causes it to lag. These two effects of lag and lead may be exactly opposite each other, in which case the current neither lags nor leads the voltage, and the two are said to be in phase with one another. Otherwise they are out of phase. When the current and voltage are in phase, the circuit is in resonance with or tuned to the impressed voltage. This is accomplished by proper adjustment of the inductance and capacity values.

The formulas for inductive reactance and capacitive reactance are simple:

$$X_L = 0.00628 fL$$

$$X_C = \frac{159.3}{fc}$$

in which X_L is the inductive reactance in ohms, X_C is the capacitive reactance in ohms, f is the frequency of the current in kilocycles, L is the inductance in microhenries, and C is the capacity in microfarads. Capacitive reactance is generally written with a negative (minus) sign before it, as it has an opposite sense with regard to the inductive reactance, the one causing a lagging, and the other a leading current.

CURVES

In Fig. 5 three curves are shown, calculated for three inductances of 50, 100 and 200 microhenries, showing how the reactance varies with the frequency. They are straight lines, and the reactance increases steadily as the frequency increases. (Continued on page 111)

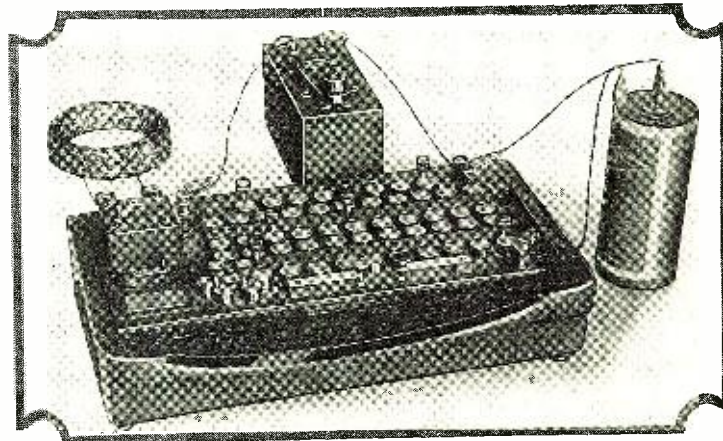

How the D.C. resistance of a coil or other conductor may be measured by means of a Wheatstone bridge.

A 40-Meter Transmitter with a Punch

By WILLIAM H. SCHICK, A.M.I.R.E., 2MU.

The trend of amateurs is toward the lower wave-lengths and this transmitter will satisfy the most exacting "ham."



MANY months ago the Department of Commerce gave the amateurs some new short wave bands, and most of the fellows have taken advantage of the 75-meter band and are doing remarkable long distance transmission, considering the power they use.

However, very few have taken advantage of the 40- and 20-meter bands, and the result is that the interference is becoming unbearable on 75 meters. There seems to be an impression among the amateurs that it

ductance. The rotary plates are not connected in the circuit at all, but turning the rotor plates in and out changes the capacity nevertheless. The .0005 condenser, when connected in this manner, has a maximum capacity of .000125, and it will stand very high voltages without breaking down. Using one 50-watt Radiotron UV-203, I have put as much as 1,500 volts and 250 mils across this receiving condenser while in circuit with the oscillator, and it did not show the slightest sign of breaking down. For the grid leak I use a standard 5,000-ohm grid resistance. Both grid and plate condensers are of fixed capacity of .002 high voltage type.

The radio frequency choke which I use in the plate circuit is much smaller than the average choke in that it has only 15 turns of No. 24 D.C.C. wire on a 4-inch cardboard tube, but this choke has been helpful in getting the oscillator to work on the extremely short waves. Across each side of the center filament tap there is a 1 mfd. condenser. This is important in that it helps to stabilize the oscillatory circuit and greatly reduces the keying thump.

TUNING

The base of the 50-watt tube was not removed as the circuit oscillates smoothly without removing it. The regulation socket is also used. All connections are made in the usual manner as per diagram, but it is important to keep all leads short and make them solid, for if they swing back and forth the signals swing also.

Before you start to tune the oscillator, it is very important to have a wavemeter handy that will cover the 40-meter band. Many wavemeters have been described before in this magazine. The rectifier and filter shown herewith was described by the writer in the May, 1924, issue of RADIO NEWS.

Connect a heavy lead from one set of stator plates of the balanced condenser to one end of the inductance and another connection from the other set of stator plates to the other end of the inductance. The plate lead goes directly to one end of the coil and the grid lead goes to the other end. All variable leads are shown in the diagram with arrows, and these leads should all have clips so that variations can be made easily. A good method of making these clips is to use the jaws of some old switches with a rubber top binding post as shown herewith.

The negative lead of the high voltage

goes about two turns above the grid lead. This connection is critical, but you will find the best adjustment about two to three turns above the grid lead. Now turn the rotor plates to full capacity, and if everything is working properly, your wave will be approximately 40 meters. The tube should not heat up at all if the circuit is oscillating properly, but if it does heat badly, try adjusting the negative high voltage lead.

When you are sure the oscillator is tuned



Antenna insulator, which is made from a glass towel-rack.

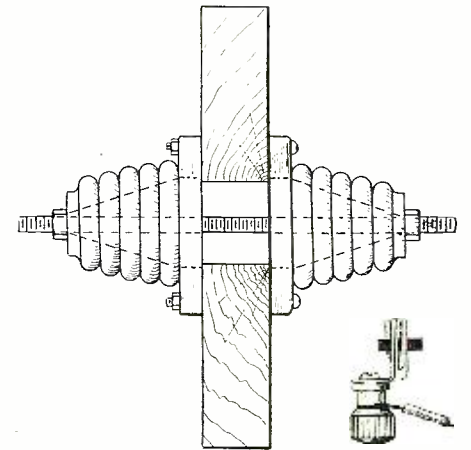

Antenna lead-in insulator, which is very easily constructed. Below: Tuning clip made from switch jaw.

is a hard problem to get a transmitter working on 40 or 20 meters, but this is not the case. With a little care and forethought, it is possible to cover these bands as easily as it is to work the 75-meter one.

Herewith is a description of my 40-meter transmitter, which will also work on 20 meters. The oscillatory circuit is the old standby, the loose-coupled Hartley circuit. When I tell you of the DX I have worked with this set in a decidedly poor location, I am sure you will want to drop your wave.

THE OSCILLATOR

The oscillator inductance is one-half of an old spark coil oscillation transformer. It consists of seven turns of edgewise wound copper strip 4½ inches in diameter, but instead of the usual spacing, it is double spaced ¾-inch between turns. This inductance is held firmly by means of two slotted dry wood strips, one on top and one on bottom of the coil. The oscillator tuning condenser is .0005 22-plate receiving condenser which has two separate sets of stationary plates insulated from one another and one set of rotor plates. It is commonly known as a balanced condenser. The condenser is mounted on a small porcelain cone insulator which is fastened to the top wood strip.

However, it is connected in the circuit in a manner not common to most amateurs. A series connection is used. By that I mean that one set of stator plates is connected to the grid side of the oscillator coil and the other set goes to the plate side of the in-

to 40 meters, you are ready to couple the antenna to the oscillator. The antenna coil happens to be the other half of the spark coil O. T. and consists of 7 turns of edgewise wound copper strip 6½ inches in diameter and is mounted on wood strips the same as the oscillator coil. The spacing between these turns can be ½ inch.

Now mount a .0005 mfd. condenser on the top of the antenna coil frame in the same manner as the oscillator condenser. Connect one side of this condenser to the aerial, the other side going to one end of the coupling coil. The counterpoise lead is connected directly to the other end of this coil. The antenna side of the coupling coil is placed nearest the plate end of the oscillator coil. There should be from 2 to 4 inches coupling between the two coils for the signals may have a tendency to be unsteady if the coils are closer than this.

Start the oscillator going by pressing the key in the usual manner and start turning the antenna series condenser from zero up and as the antenna comes in resonance with the oscillator you will notice that the mils on the plate of the tube will begin to rise until the condenser comes to a point where they will fall back again. This shows that you have passed resonance. Begin over again but do not pass this point, and by watching the milliammeter and antenna meter, you can soon tell when you have the best adjustment. Press the key a number of times and see if the meter reads the same, for sometimes when the set is not tuned properly, the antenna current will vary each time the key is pressed and your signals will not be steady.

You are now ready for the DX, but before going further I will mention a few words about antennæ for short waves. For 40-meter work do not use a large antenna because it is difficult to tune to resonance.

(Continued on page 82)

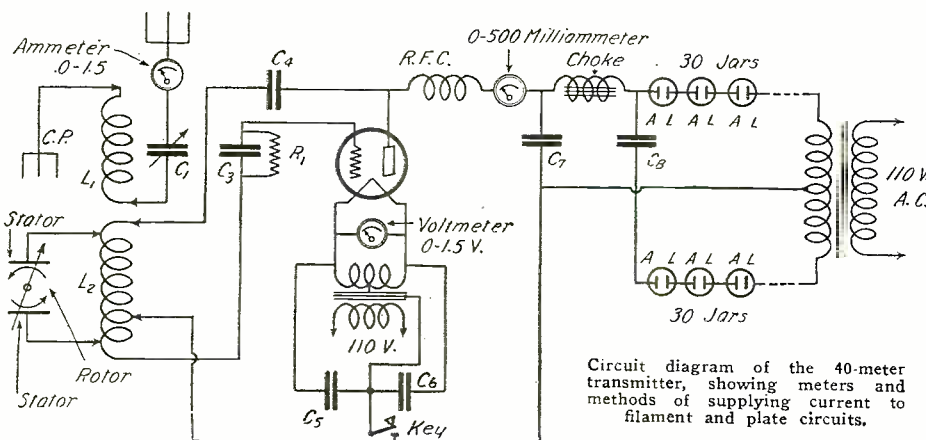

Circuit diagram of the 40-meter transmitter, showing meters and methods of supplying current to filament and plate circuits.

- Radiotics -

PAGE MR. VOLSTEAD



The *Daily Progress* of Charlottesville, Va., on March 25, ran a radio advertisement which read, in part: "Write today for ILLEGAL ten-day trial offer of Thielen's Music Box Radio Receiver." We wonder if this is one of those damped wave receivers, capable of getting more than one-half of one per cent.

Contributed by Ellis E. McCoy, Jr.

NEW MEASUREMENT UNIT

The *Radio Journal* of April, 1925, runs a heading of a list of broadcast stations "showing wave-length in MOTORS." If this new unit has been adopted by the Bureau of Standards, we think it rather strange that it was not announced to the world in general.



Contributed by D. C. Montgomery.

DO THEY SQUEAL VICIOUSLY?



In the *Western Financial Reporter* of Denver, Colo., of April, 1925, there is a description of a set, as follows: "A low-priced FIVE-TOOTHED radio frequency receiver." In this cage, ladies and gents, is the far-famed radio bug. When he bites, has his victims suffer! Larry, turn the crank!

Contributed by V. DelWilde.

CLOSE QUARTERS

The *Radio Section* of *New York Sun*, New York, N. Y., on March 28, ran an advertisement of a Freshman kit, advising that it was "Wired free while YOU WAIT IN A COMPLETE SET." We assume that, while waiting, you get thoroughly familiar with all the apparatus in the receiver.



Contributed by Thomas Foley, Jr.

MANY OF THEM SHOULD BE SENT FAR AWAY



In the *Pittsburgh Press*, Pittsburgh, Pa., of March 22, there is a headline that reads "Authorize license for BROADCASTING station operators." The way some programs come over the air we wish that some operators could be broadcast "far, far away."

Contributed by N. R. Mamula.

THIS IS A WILD ONE!

In the *Daily News* of Chicago, Ill., of March 13 there is advertised a "Tungar BULL-CHARGER." With this charger in the house, charging a battery would be merely a matter of nutting the animal—and let 'er rip!



Contributed by James Schultz.

NO MORE HORNS AND SOUND BOXES

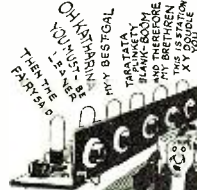

An advertisement in the *Cleveland Press*, Cleveland, Ohio, of March 20 includes in a list of parts "The Brandes TUBE-Talker." Hooray! Now we won't have to be bothered with any more horns. The tubes will be used both as amplifiers and loud speakers.

Contributed by M. T. Cook.

ALL THE TRIMMIN'S

In *Radio News* for May, 1925, appears the following advertisement: "De Luxe Crystal Set, complete with head-phones, aerial and GROUND, \$10." Does the buyer of this outfit get a city lot or a carload of choice earth for the ground? Real estate agents please notice.



Contributed by A. Hirschfeld.

FOR THE BOOTLEGGER



In the San Francisco, Cal., *Bulletin* of April 6 is offered a "Five-tube GILL-FILLER Neutrodyne." Here, boys and girls, is the combination radio receiver and measure for the "bootleggers' delight," used on all the best boats of Rum Row.

Contributed by G. E. Michael.

WHAT KIND OF A BANK?

In *The Enquirer* of Cincinnati, Ohio, of March 18 in the *Radio Reviewer's* Column was this gem: "Moving over to WRC under the impression that the MARINE BANK WAS TO PLAY over that station." This is quite an attraction for a station to have on its program and WRC is to be congratulated.



Contributed by J. C. Gallaher.

A NEW CITIZEN



In an advertising sheet from the C. A. Buscher Co. of Kansas City, Mo., is this description of their receiver: "It has tuned radio frequency, SELF-NATURALIZED. Extremely simple operation." If the inventor of this process will loosen up, what a lot of worry will be saved the "poor alien who forever knocketh at our door."

Contributed by Geo. E. Manzer.

If you happen to see any humorous misprints in the press, we will be glad to have you clip them out and send to us. No RADIOTIC will be accepted unless the printed original giving the name of the newspaper or magazine is submitted. We will pay \$1.00 for each RADIOTIC accepted and printed here. A few humorous lines from each correspondent should accompany each RADIOTIC. The most humorous ones will be printed. Address all RADIOTICS to

Editor RADIOTIC DEPARTMENT,
c/o Radio News.

BROADCASTERS, PLEASE NOTICE

In the *Dearborn Independent* of March 21 was a description of the broadcast station in Zion City, Ill. In part, it was reported that "a pick-up instrument, or MICROSCOPE, mounted on a standard conveys the voice—" And further on it has: "Here the music or voice is amplified by means of vacuum tubes which increase the volume of the SOUND WAVES thousands of times." We are certainly indebted to Hank Ford for this valuable information.

Contributed by C. H. Weatherill.

IT CAN'T BE DONE



In the *Radio World* of April 4, 1925, in an article on trouble-shooting is the following advice for a simple test: "TOUCH THE GRID OF THE TUBE WITH A WET FINGER." A rather drastic test and sort of hard on tubes. Also, it requires a good hefty wallop.

Contributed by R. D. Black.

HOW HEAVY IS AN OHM?

The *Philadelphia Pa., Record* of April 3, in describing a set, notes that a leak was used of "two meg-ohms (2,000,000 TONS)." When one of these leaks is mounted in a set, it takes a dozen cranes used in the ship-yards to get it into place.

Contributed by T. F. Norris.



THIS LAD WAS CLEVER



The Buffalo, N. Y., *Times* of March 16 has the following: "The set illustrated above was recently constructed by the writer ON A SINGLE-WIRE ANTENNA 30 FEET HIGH and only 50 feet long in a POOR LOCATION." This feat should go down in history with such an event as the famous dive of Steve Brodie from the Brooklyn

Bridge.

Contributed by Chas. P. Kopperman.

SORT OF LAZY, EH?

On April 1 the Rochester, N. Y., *Times-Union* had this head for an article: "SUMMER RECEPTION OF WINTER BROADCASTING." We were aware that they had heavy snows up in that neck of the woods, but we never imagined that it would impede the progress of radio waves!



Contributed by Andrew Almy.

SOMETHING NEW IN BATTERIES



On March 6 *The Saratogian* of Saratoga Springs, N. Y., in the *Classified Column* advertised a "Four-volt radio storage battery, WITH STARTER, for sale. We are glad that someone has put something on the market that will start sets which get balky streaks.

Contributed by Geo. E. Allen.

ONE WAY TO INCREASE FIGHTING FORCES

On the Query Page of the *Washington Herald-Broadcast*, April 11, of Washington, D. C., one answer has it that "We are herewith publishing a RECRUIT—" When the next war comes along, instead of drafting the forces from the populace, armies may be furnished literally through the Press.



Contributed by Mrs. E. L. Grimm.

HERE COME THE COPS!



In the *Pittsburgh Pa., Press* of March 29 we find this advertisement: "Three-tube set BARE, \$20 and Freshman factory built, MOSTLY BARE \$40." If Florenz Ziegfeld hears of this set, next winter perhaps we'll see radio in the Follies. Maybe these sets were out for a swim and had to go home in the well-known barrel.

Contributed by H. B. Stoner.

THEY COULD BE USED AS TRAPS

In the Los Angeles, Calif., *Evening Express* of Feb. 5 there is mention made of "an IRON DOOR TRANSFORMER." Doubtless this is provided with a combination lock to keep out any disturbing factors that might spoil the reception and to keep in any wandering hysteresis.



Contributed by J. H. Braome.

QUITE A LOOP

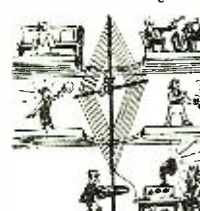

In the April 26 issue of *Radio Doings*, of Los Angeles, Calif., the Palmer Radio Co. advertises a receiver "—and positively guarantee you Chicago, Calgary and Des Moines on loud speaker, using a 30-FOOT LOOP, and we don't mean maybe." Now that is what we consider quite a mean threat (or a promise), but we will say this much, they didn't advertise the outfit as being portable.

Contributed by E. P. McGurk.

Correspondence From Readers

RE: REGENERATIVE NEUTRODYNE

Editor, RADIO NEWS:

I have just received a copy of your April issue of RADIO NEWS, and on looking through this my attention was arrested by one article, "The Regenerative Neutrodyne," by Mr. A. L. Groves. 3BID.

On reading through this article, I was a little surprised to note that one of the published diagrams, *i. e.* Fig. 6, is practically a duplicate of a circuit I used in designing a selective long distance receiver in October of 1923. Actual construction was begun in November, and the completed set was ready for testing in February of 1924.

It has proved itself to be a very successful piece of apparatus from the start and has been in constant use up to the present time.

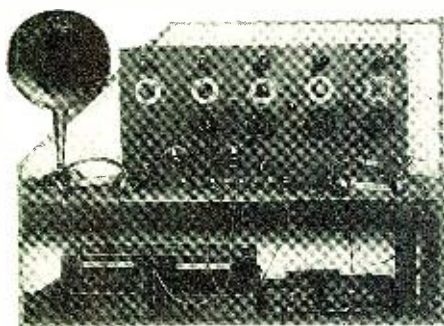

Regenerative Neutrodyne receiver built by Mr. Nelson of Glasgow, with which he has received many American stations.

It was designed to cover a wave-length range of from 250 to 650 meters, but fails to cover the entire range successfully, on account of the plate variometer, which is too large for wave-lengths below about 300 meters and too small for those over about 750 meters. The windings of this variometer are in series, and no provision was made for connecting them in parallel when the set was assembled.

However, I am about to dismantle and reconstruct this receiver, when several alterations for improvement will be considered.

The whole of the receiver, except the R.F.

transformers, was built up from standard manufactured components available at that time, nothing but the best being considered.

The R.F. transformers were self-constructed, being specially designed and wound. They are made up from ebonite tube and mounted on ebonite bases fitted with five pins for plug-in arrangements. Primary coil: $2\frac{3}{4}$ -inch diameter 1-inch long, containing 20 turns No. 24 D.C.C. Secondary coil: 3-inch diameter 3 inches long, containing 70 turns No. 24 D.C.C. with a tapping taken at the 20th turn.

The three transformers are exactly alike and the secondary windings are each tuned with square law variable condensers of .00025 mfd. capacity. The condenser which gave the lowest reading with each of the transformers was arranged to tune the aerial transformer, and the other two were then fitted with verniers so that, for a given wave-length, each of the three condenser dials registered the same reading. In actual working the readings between 40 degrees and 160 degrees are regular at 3 degrees. increase on dial giving a 10-meter increase in wave-length. Above and below these limits slight variations then occur.

The variometer in the anode circuit of the detector valve is a standard anode variometer for 300/500 meters. For reaction purposes, it operates from just below 300 meters up to about 570 meters, the windings being in series as mentioned earlier.

As regards results this receiver has given every satisfaction, being very sensitive and extremely selective.

All the B.B.C. stations in Britain—both main and relay—are easily received, some with three tubes and others with four tubes. The distances vary from 40 miles up to 400 miles.

Several of the Continental broadcast stations in European countries also come in excellently on the phones, reaching in a southerly direction to Seville, Madrid and Barcelona, in a southeasterly direction to Vienna, Rome and Budapest, whilst on the east many stations right through Germany to Breslau in Silesia are also well received, the distances varying from 1,000 to 1,600 miles.

Dutch, Danish, Belgian and French stations at 500 to 700 miles are easily brought in.

From the west—several U. S. A. and Canadian stations have also been well received on the phones under average conditions, the following being the best heard: *W'GY, W'BZ, W'JY, W'JZ, W'OR, W'RC, KGO, KDKA, WEAF, WTAM* and Canadian CFAC.

On very favorable occasions those stations in italics have been received on the loud speaker on four tubes, *i. e.*, 2 R.F.—D—

ARE you interested in motoring, touring or camping? If you are, do not fail to read the July issue of

MOTOR CAMPER AND TOURIST

Here is a magazine that tells you things in connection with your car—things that you never even suspected.

Are you just running around the country or are you getting the full benefit of your car? **MOTOR CAMPER & TOURIST** shows you the way. On all newsstands.

CONTENTS FOR JULY ISSUE

The Northward Trek, By Richard K. Wood
Where to Camp.....By Charles B. Roth

Camps & Camping.
By Ludwig S. Landmichl

From Boston to Quebec, Montreal and The White Mountains.... By Mary Thornhill

A Woman, A Car and More or Less Trouble.....By F. L. Allen

Motoring in British Columbia.
By Mrs. Stephen Nease

How to Build a Camping Car.
By Maristan Chapman

Fourteen Miles Through Granite.
By Lewis Lemuel Thomas

1 A.F. The use of two stages of audio frequency amplification usually results in too much extraneous noise, static, etc.

I inclose a blueprint of the circuit as used at present, and also a photo of the front panel of the receiver, from which you will observe that the tubes are panel-mounted outside (not a desirable arrangement when it comes to wiring up). However, as I mentioned earlier, I am about to dismantle

(Continued on page 114)

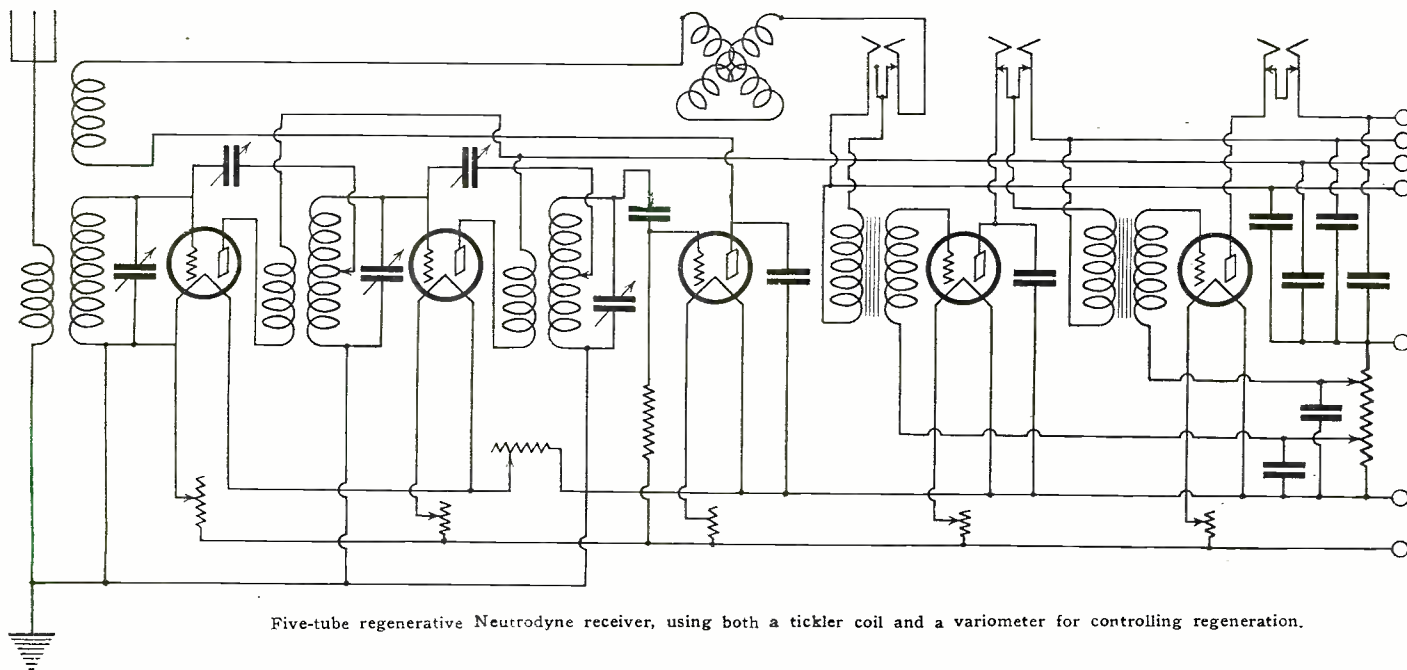

Five-tube regenerative Neutrodyne receiver, using both a tickler coil and a variometer for controlling regeneration.

Awards of the \$50 Radio Wrinkle Contest

First Prize

VIBRATION-PROOF TUBE MOUNTING

By D. M. LYNCH

One of the bugbears of many receivers is the various noises that are set up in the tube by the vibration of the elements. Here is a method to eliminate these annoyances.

Two layers of felt discs are squeezed lightly to about 1/2 inch in thickness. Sheet felt may be used or the felt packing that comes wrapped around vacuum tubes. It should be noted that too much compression destroys the shock absorption properties of the felt. The two layers of felt discs are fastened to the baseboard by a wood screw and washer, the upper layer being bolted lightly to the socket by means of two small bolts through a ring of light wood or fibre. A second wooden ring next to the socket acts as a spacer, providing ample separation of the socket contact springs from the head of the wood screw. A fibre or wooden washer under the head of the screw provides a good grip on the felt, which should be rather loosely held. The tube should "wobble" easily with a slight force.

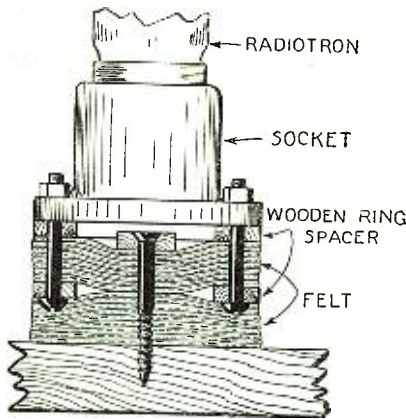

By the use of felt to take up vibrations, as shown, microphonic noises are eliminated.

Both screw and bolts should be of brass to prevent the small amount of magnetic absorption of iron. Of course, the connecting wires to the socket should be flexible to fully benefit from the cushion mounting. Raising the sockets in this manner allows more wiring space under the socket. Crowding wires, especially in a very sensitive set, frequently causes small capacity effects and results in many troubles.

Second Prize

LOW LOSS INDUCTANCE

By W. E. CONDIT

The inductance here described is not difficult to construct and requires very little preparation. A piece of bakelite or hard rubber tubing of the desired diameter of the coil is slotted as shown in the accompanying illustrations. There should be at least ten slots and they should be 1/2 inch longer than the finished coil. Cut a disc of soft wood 1/4 inch thick, with a diameter equal to the internal diameter of the tubing. Place this disc inside the tubing and fasten it with beads, as shown.

Wind the number of turns on the tubing that is called for in the construction of the coil, using two wires—one for the winding

and the other for a spacing wire. A very satisfactory combination is No. 20 wire for the winding and No. 28 for the spacer wire.

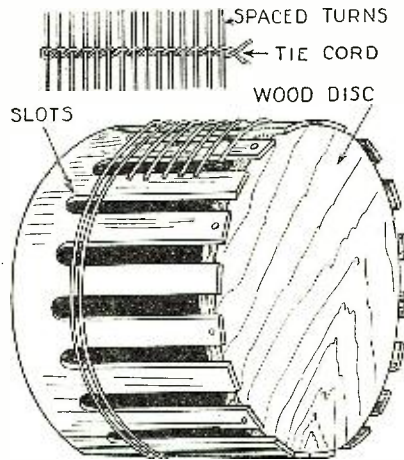

Low resistance, air-core inductances may be wound by this method.

When the spacer wire is removed, the coil will be found to be equally spaced on the tube. At each slot tie the coil as shown in figure so that none of the turns are shorted against each other. Pull out the brads holding the wooden disc in place and remove it. This allows the tube to contract so that the coil may be easily slipped off. With a small brush carefully paint the string that has been used for tying the turns in place, with shellac or collodion. This also adds to the rigidity of the coil.

binding posts. Insert the wire in the tube, which it will fit snugly, and solder the binding posts to the two ends. Now drill a 5/8 of an inch hole vertically in the top section of the lower sash, as shown in the sketch, so it will come outside the glass. The tube, with the wire enclosed, is inserted in this opening. The beauty of this arrangement is that the lead-in is kept clear of the building, while, at the same time, either sash can be raised or lowered as desired by bending the wire.

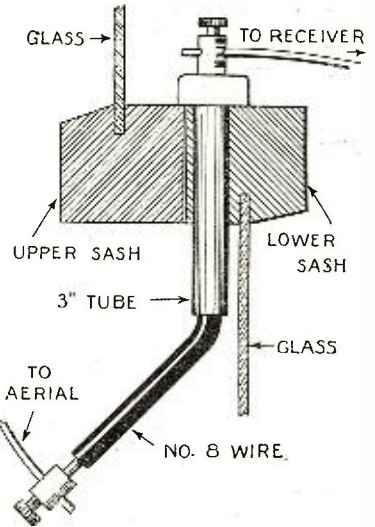

Drill a hole in the outside sash for the porcelain lead-in tube.

IMPROVING THE APPEARANCE OF RADIO CABINETS

Using metal corners to hold the panel of a radio set in the cabinet will not only eliminate the usual unsightly screws through the front of the panel, but will considerably improve the appearance of the cabinet as well. The interior of the set is made easily accessible for inspection simply by removing the two metal corner pieces and the screw in the back of the cabinet.

The metal corner pieces can be of sheet brass or copper. Lay out either of the patterns shown in the sketch below and cut out the shaded portion, then drill and countersink the two holes to pass a small-sized wood screw. After cutting out the pattern and drilling the holes, clamp the pieces in a small vise and bend in along the dotted lines as shown. Now remove the pieces from the

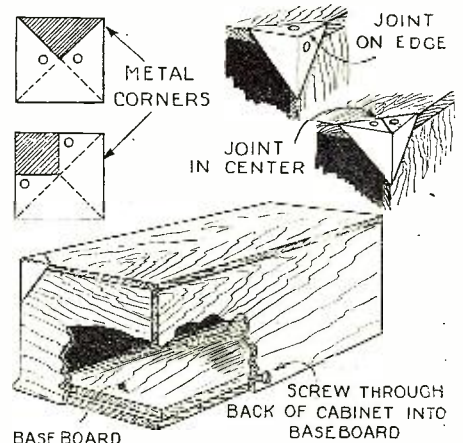

The use of metal corners to hold panel to cabinet eliminates any need for screws.

Prize Winners

First Prize \$25

VIBRATION-PROOF TUBE MOUNTING

By D. M. LYNCH,

2600 N. Piedras, El Paso, Texas

Second Prize \$15

LOW LOSS INDUCTANCE

By W. E. CONDIT,

R. F. D. No. 4, Toledo, Ohio

Third Prize \$10

RAINPROOF LEAD-IN

By J. D. McCURUM

27 Swanwick Ave., Toronto, Canada

Note: The next list of prize winners will be published in the September issue.

Third Prize

NO RAIN TROUBLE WITH THIS LEAD-IN

By J. D. McCURUM

There is no trouble from rain with the method given herewith for bringing a lead-in wire into the house. This lead-in is also very neat in appearance and easy to install. The only materials required are a porcelain tube 3 inches long of the kind commonly used in house wiring, a 1-foot length of No. 8 black rubber-covered wire, and two

vise and procure some metal polish and polish the pieces up to as high a polish as you can get. They are now ready to attach to the cabinet.

The pattern in Fig. 1 will make a corner piece with the seam (where the two edges join) coming along the upper outside edge of the cabinet, as shown in Fig. 2.

The pattern shown in Fig. 3 will make a corner piece with the seam coming in the middle, as shown in Fig. 4.

Screw the panel to the baseboard, then insert the whole thing into the cabinet as shown in Fig. 5. Drill and countersink a small hole in the back of the cabinet to pass a small wood screw, then insert a screw in the hole just drilled and screw it into the baseboard. This will hold the bottom of the panel and baseboard firm, while the two metal corner pieces will keep the top of the panel in place.

This method makes a very neat job, and the polished metal corner pieces improve the external appearance of the set considerably.

Contributed by Percy A. Field.

A VARIABLE COIL WINDING JIG

Inductances should be prepared with the greatest care and consist of the proper materials and correct design. The extremely minute energy collected by the antenna must be handled skillfully if we are to make secondary apparatus function to the best advantage. Coils then should be wound subject to as little dielectric material as possible, distributed capacity reduced to a minimum, and high frequency losses materially lowered. Staggered weave coils, supported with a fraction of insulation, meet this requirement as nearly as it is possible to do so. With this end in view there has been designed a cheaply made variable coil winding jig, so

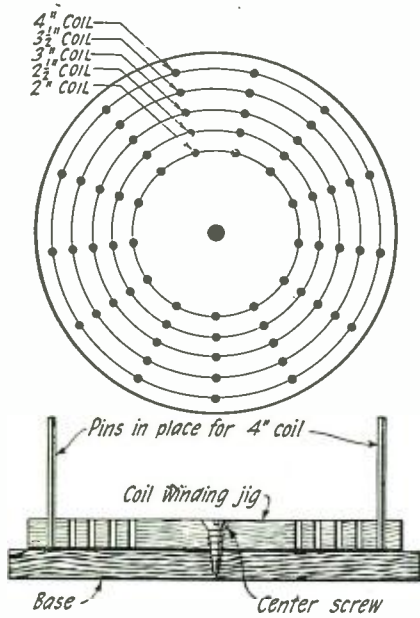

When holes are drilled, as indicated, and pins inserted in any set of holes, an excellent winding jig is produced.

that staggered weave coils of practically any diameter may be wound. All that is necessary to vary the dimension of the coils is to move the pins to their proper holes. Above is shown a template pattern giving the exact position and odd number of pins.

The first requisite is a round, hard wood block 5 inches in diameter and 5/8 inch thick. Lay a template in the exact center of this block and with a sharp-pointed instrument punch hard enough through the paper, exactly on the dots, to leave a pattern in the wood. This is a drilling pattern and can be made to show up much plainer by marking with a pencil in the indentations. The pins are simply long finishing nails and can be purchased at any hardware store. If extra long

coils are to be made, the pins may be cut from stiff wire to any length desired. Care must be exercised, however, in choosing a drill of the right diameter so that the pins

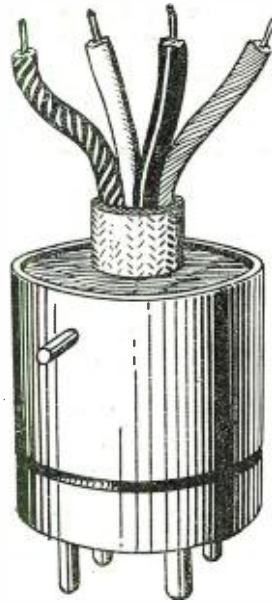

Fig. 2. A discarded electron tube base may be used for a battery switch by soldering leads having different-colored insulation to the prongs.

will fit the holes snugly. After selecting the proper drill, bore the holes completely through the hard wood block, holding the drill perfectly straight. Next, with a larger drill, bore out the center for a fastening screw (see Fig. 2). Thus completed, it will give you five diameter variations of the 13 pins, making it easy to wind a coil to specifications.

In making staggered windings, start with any pin and weave in and out of every other pin. The second time around should cross that of the first, and so on. Once correctly started, it is an easy matter to get the proper results. Before slipping the pins from the coil block, bind each turn of wire by sewing securely with silk thread. This should be done in three places. For the coil support, and directly opposite from where it has been sewed, force a narrow piece of good insulation through the entire length of the coil. The insulation should be just wide enough to go through the coil layers and accommodate a very small wood screw at its end (see Fig. 3). Drill a series of small holes just large enough to pass a needle in this insulation support, and sew the finished article. The finished inductance needs no shellac for the windings and a minimum of insulation, making a very efficient and good-looking unit.

Contributed by Loyal F. Garris.

HOME-MADE TUBING

Everyone who has a phonograph has the problem of what to do with the old records. Here is a solution that is also a money-saver for the radio fan. Mark the records

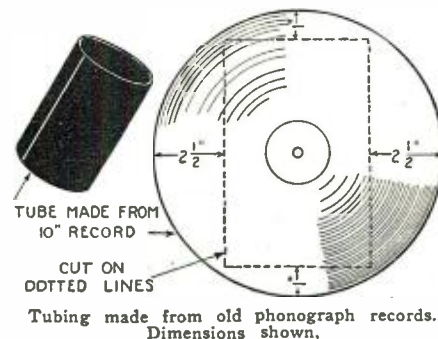

as shown on the accompanying diagram with a scribe, the length being equal to the circumference of the tube desired. Place the record in a medium hot oven and allow it to remain until it becomes soft, when it can easily be cut with a sharp knife or a large pair of scissors. A cylindrical form a little smaller than the desired diameter of the tube is prepared, around which the flat piece of record is wrapped after being reheated. When the record has become cool, it will hold this cylindrical shape very well. The inside form is then removed and the edges of the piece of record made to fit closely together. If desired, some cement may be placed on the inside of the tube to hold the edges together, but when the windings of the coil are placed on the tube, they will tend to hold it in place. These tubes are easily made and are superior to the cardboard variety.

Contributed by Rufino Ramirez.

USES FOR VACUUM TUBE BASES

In Fig. 1 is shown the method of mounting a honeycomb coil in an old vacuum tube base. First clean out the base of the insulating material. The coil is mounted on the base as shown, and the leads, soldered to two of the prongs, are fastened with a thin strip of insulation passing through the center of the coil and soldered to the base. By connecting two leads to the corresponding terminals of a socket an excellent mounting is provided.

In Fig. 2, four leads having different colored insulation are soldered to the four prongs of the base and then brought out, as

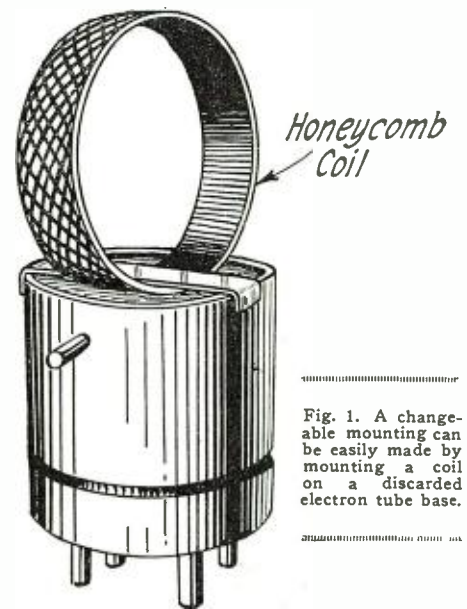

shown. The space around the wires is filled up with sealing wax. Leads are run to terminals of a socket, so that the base may be used as a battery switch.

Contributed by A. Malmros.

HOME-MADE VACUUM TUBE SOCKET

For the constructor who likes to make as much of his apparatus as possible the socket below should prove of interest. Procure a piece of hard rubber or bakelite 3 1/4 inches square. In the center of this piece drill a hole in which the base of an electron tube will fit snugly. The coil spring guards of four nickel-plated safety pins 1 1/2 inches long are removed and arranged on the bakelite square, as shown in the illustration. Mark the points where the holes are to be drilled for the screws, after inserting the tube in the hole made for it and thus fixing the

(Continued on page 84)

New Radio Patents

By JOHN B. BRADY

ELECTRICAL VARIABLE CONDENSERS

(Canadian Patent No. 245,287, A. E. Chapman. Filed January 14, 1924; issued December 16, 1924.)

The invention consists of a multiple variable condenser having more than two groups of plates, with means on at least two of the said groups for

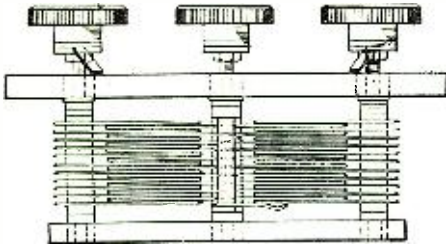

moving each one of them independently from one another relatively to the other groups, and an electrical terminal on each group whereby the condenser is rendered capable of being inserted in at least two circuits, which are thereby capable of being controlled independently of one another.

RECEPTION OF CONTINUOUS WAVE WIRELESS SIGNALS

(Canadian Patent No. 241,277, H. J. Round. Filed May 28, 1923; issued July 1, 1924. Assigned to The Marconi Wireless Telegraph Co. of Canada, Ltd.)

The invention consists of a method of receiving continuous wave signals, which consists of

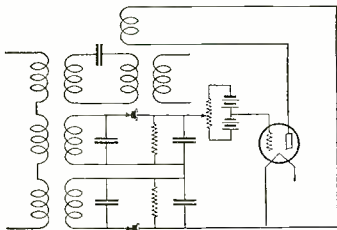

applying a heterodyne thereto, causing a variation in the beat currents so produced, due to a change in the frequency of the waves, to affect the potential of the grid of a valve and causing such alteration in potential to change the frequency of the heterodyne.

RADIO TRANSMISSION SYSTEMS

(Canadian Patent No. 242,542, J. O. Mauborgne and Guy Hill. Filed September 13, 1922; issued September 2, 1924.)

The invention consists of a system of transmitting radio signals, consisting of an antenna system, comprising an antenna, a wave coil, tun-

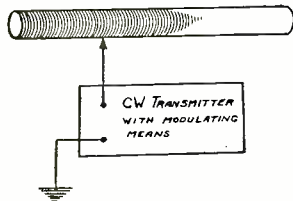

ing elements and ground connection, all connected in series; said tuning elements are associated operatively with an energy source of undamped oscillations, means for adjusting the frequency produced on said antenna system to be in resonance with the frequency of the said energy source, and means for modulating telephonically the said source of undamped oscillations for the purpose of signaling.

RADIO APPARATUS

(Canadian Patent No. 241,602, D. Grimes. Filed September 19, 1923; issued July 15, 1924. Assigned to Grimes Radio Engineering Co., Inc.)

The invention consists of a system comprising a plurality of amplifiers arranged for inter-stage operation, certain of said amplifiers being oper-

able to amplify electrical current variations of a plurality of frequencies simultaneously, wherein current variations within one band of frequencies are amplified by said amplifiers in a predetermined sequence, and current variations with-

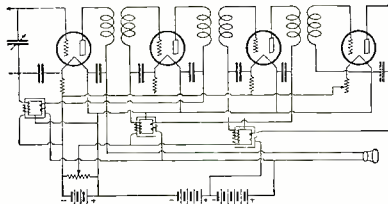

in a different band of frequencies are amplified by at least two of said amplifiers in the inverse sequence to that in which said last-mentioned amplifiers amplified current variations within said first-mentioned band of frequencies.

RADIO COMMUNICATION SYSTEMS

(Canadian Patent No. 242,541, J. O. Mauborgne and Guy Hill. Filed September 13, 1922; issued September 3, 1924.)

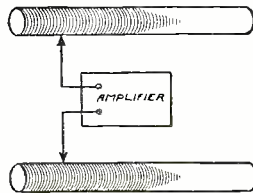

The invention consists of a system for receiving radio signals, comprising a wave coil antenna, a multi-stage amplifier, the grid input terminal of said multi-stage amplifier being connected to a point on said wave-coil antenna, the filament terminal of said multi-stage amplifier being connected to a point on another wave coil.

RADIO RECEIVING SYSTEMS

(Canadian Patent No. 244,945, C. W. Rice. Filed November 28, 1923; issued December 2, 1924. Assigned to Canadian General Electric Co., Ltd.)

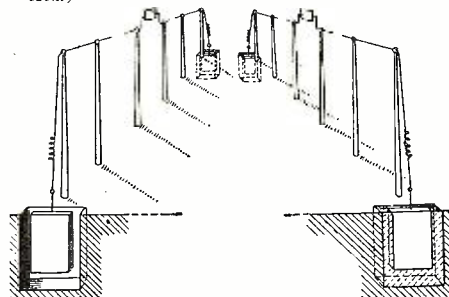

The invention consists of the combination in a radio receiving system of a plurality of receiving antennae, arranged in a row extending in a direction substantially at right angles to the direction of the signals to be received, and separated from each other by a substantial fraction of a wave-length of the signals to be received, a receiving apparatus, balanced transmission lines connecting each antenna with the receiving apparatus, and means at the receiving apparatus for adjusting the phase and intensity of the currents impressed from each transmission line upon the receiving apparatus.

HIGH FREQUENCY SIGNALING SYSTEMS

(Canadian Patent No. 244,941, E. F. W. Alexander. Filed June 30, 1923; issued December 2, 1924. Assigned to Canadian General Electric Co., Ltd.)

This invention consists of a system for producing high frequency oscillations, comprising an electron discharge device having a cathode, an anode and a grid, a supply circuit connecting the cathode and anode, a high frequency oscillating circuit associated with said device in such a way that high frequency oscillations will be produced

therein, and a low frequency oscillating circuit associated with said supply circuit in such a way

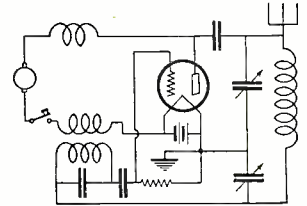

that low frequency oscillations will be produced therein of an amplitude proportional to the energy supplied to the device.

VARIOMETER

(Canadian Patent No. 245,333, L. L. Jones. Filed May 26, 1924; issued December 16, 1924.)

The invention consists of a variable inductance comprising a stator formed of a set of flat coils, each coil comprising oppositely wound coil sec-

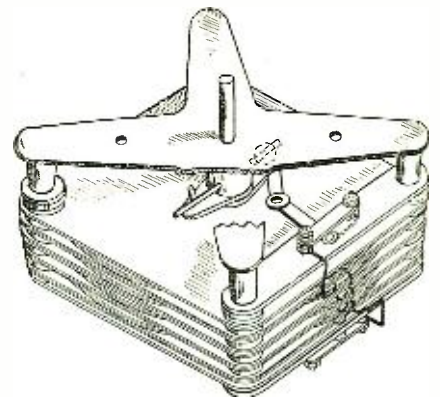

tions wound in a single plane, and a rotor also formed of a set of flat coils, each coil comprising oppositely wound coil sections wound in a single plane, the coils of the stator set and the coils of the rotor set being arranged in alternating, interlacing relation.

ELECTRON DISCHARGE APPARATUS

(Canadian Patent No. 244,940, D. C. Prince. Filed June 30, 1923; issued December 2, 1924.)

The invention consists of an electron discharge apparatus comprising a device having an electron-emitting cathode and a co-operating anode, a grid interposed between cathode and anode, means for impressing a positive potential upon said anode to permit the flow of electrons from cathode to anode, means for impressing a higher positive potential upon said grid during the time when

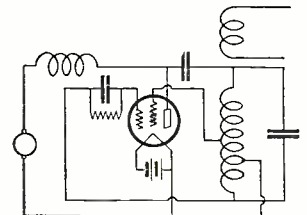

it is desired to have current flow to the anode, a second grid interposed between the first grid and the anode, and means for maintaining the second grid at a lower potential than the anode during the time when current flows to the anode.

WIRELESS TRANSMISSION AND RECEPTION

(Canadian Patent No. 244,487, E. T. Fisk. Filed November 28, 1923; issued November 18, 1924.)

The invention consists of a wireless radiating or collecting system, comprising complementary capacity areas, insulated, disposed in horizontal relation, and located in or in proximity to earth, and means for electrically charging or for absorbing electrical energy from said condensers.



RADIO NEWS LABORATORIES

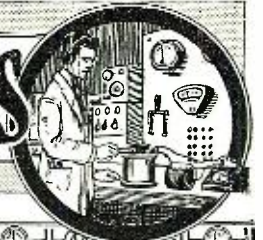

RADIO manufacturers are invited to send to RADIO NEWS LABORATORIES, samples of their products for test. It does not matter whether or not they advertise in RADIO NEWS, the RADIO NEWS LABORATORIES being an independent organization, with the improvement of radio apparatus as its aim. If, after being tested, the instruments submitted prove to be built according to modern radio engineering practice, they will each be awarded a certificate of merit, and a "write-up" such as those given below will appear in this department of RADIO NEWS. If the apparatus does not pass the Laboratory tests, it will be returned to the manufacturers with suggestions for improvements. No "write-ups" sent by manufacturers are published on these pages, and only apparatus which has been tested by the Laboratories and found to be of good mechanical and electrical construction is described. Inasmuch as the service of the RADIO NEWS LABORATORIES is free to all manufacturers whether they are advertisers or not, it is necessary that all goods to be tested be forwarded prepaid, otherwise they cannot be accepted by the Laboratories. Apparatus ready for the market or already on the market will be tested for manufacturers, as heretofore, free of charge. Apparatus in process of development will be tested at a charge of \$2.00 per hour required to do the work. The Laboratories shall be glad to furnish readers with technical information available on all material listed here on receipt of a stamped envelope. The Laboratories can furnish resistances of the various instruments, amplification curves of transformers, losses in condensers, etc., and other technical information. Address all communications and all parcels to RADIO NEWS LABORATORIES, 53 Park Place, New York City.

OZARKA

This set, submitted to the RADIO NEWS LABORATORIES, by Ozarka, Inc., Peoria and Washington Sts., Chicago, Ill., has met with our approval. It contains two stages of tuned radio frequency amplification, detector, and two audio. It operates

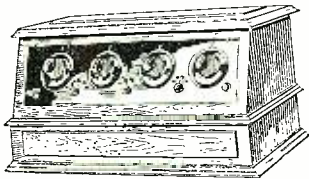

very satisfactorily over the complete broadcast wave range; the selectivity and quality of reproduction are very good. 201-A or 301-A tubes may be used with the usual voltages.

AWARDED THE RADIO NEWS LABORATORIES CERTIFICATE OF MERIT NO. 778.

DON-MAC PROTECT-O-TUBE

The tube protector, submitted by the Don-Mac 29 S. Desplains St., Chicago, Ill., to the RADIO NEWS LABORATORIES, satisfactorily protects all 1/4 ampere tubes from burning out. The protector has a resistance of approximately 350 ohms

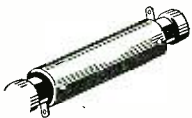

which permits passage of 1/4 of an ampere when using 90 volts on the plate circuits of the tubes. It is to be used in the negative connection of the "B" batteries.

AWARDED THE RADIO NEWS LABORATORIES CERTIFICATE OF MERIT NO. 765.

RADIO SET OF SIX TOOLS

This radio set of six tools submitted to the RADIO NEWS LABORATORIES for test by the Perry-



Fay Company, Elyria, Ohio, is a very valuable adjunct to the radio laboratory and to the experimenter. There are six sizes of sockets furnished with a socket holder which will be found to fit almost any kind of hexagonal nut used in radio construction. Some of these sockets are made to fit circular nuts, having a milled surface on the inside of the socket which will grip the circular nut.

AWARDED THE RADIO NEWS LABORATORIES CERTIFICATE OF MERIT NO. 788.

ERLA CONDENSERS

An assemblage of fixed condenser, manufactured by the Electrical Research Laboratories, Inc., 2500 Cottage Grove Ave., Chicago, Ill. were submitted to the Radio News Laboratories for test. These condensers were measured and found to have capacities within 10 per cent. of their rated values. They are efficiently built and retain their calibration under all ordinary conditions and uses.



AWARDED THE RADIO NEWS LABORATORIES CERTIFICATE OF MERIT NO. 777.

MAGNAVOX VACUUM TUBE

This new type Magnavox tube was submitted to the Radio News Labor-

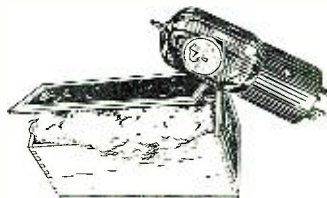

atories for test by the Magnavox Company, Oakland, Calif. It operates under the usual filament and plate voltages and proves very satisfactory when used as a detector or amplifier.

AWARDED THE RADIO NEWS LABORATORIES CERTIFICATE OF MERIT NO. 808.

ECKHOUSE WET "B" BATTERY

This battery consists of 24 small storage cells, giving a total voltage of 48 volts. It can be used satisfactorily for supplying "B" voltages



in receiving sets. Submitted to the RADIO NEWS LABORATORIES by Hor-

ace H. Eckhouse, 1834 Broadway, New York City.

AWARDED THE RADIO NEWS LABORATORIES CERTIFICATE OF MERIT NO. 692.

ALADYNE

Submitted for test to the RADIO NEWS LABORATORIES by the Alladin



Manufacturing Co., Muncie, Ind. This set contains two stages of tuned radio frequency amplification, detector, and two audio. It operates very satisfactorily over the complete broadcast wave range and the selectivity and quality of reproduction are very good. The set uses 201-A or 301-A tubes on the usual voltages.

AWARDED THE RADIO NEWS LABORATORIES CERTIFICATE OF MERIT NO. 779.

ERLA TUBE SOCKET

The socket shown in the illustration, submitted by the Electrical Research Laboratories, 2500 Cottage Grove Ave., Chicago, Ill., to the RADIO NEWS LABORATORIES, is made of molded insulating material and is sturdily constructed. The special feature in this socket is the employ-

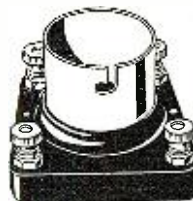

ment of two contact prongs placed on top of one another when it is customary to use only one. This assures retention of the spring qualities of the contact.

AWARDED THE RADIO NEWS LABORATORIES CERTIFICATE OF MERIT NO. 785.

SATURN JACKS

RADIO NEWS LABORATORIES has received from the Saturn Manufactur-



ing Co., 48 Beekman St., New York City, a number of jacks for test. These jacks come with various numbers of prongs and contacts and are

used for a number of purposes. There is also a switch attachment



which can be screwed in front of the jack in the place of an ordinary jacknut, so that the jack can be operated as a switch. These jacks are well constructed and will operate satisfactorily in any set.



AWARDED THE RADIO NEWS LABORATORIES CERTIFICATE OF MERIT NO. 786.

UNITRON RECTIFIER

The Unitron Rectifier, made by the Forest Electric Co., 272 New



St., Newark, N. J., and submitted to the RADIO NEWS LABORATORIES for test, consists of a transformer operating a Tungar Bulb. It is designed to charge both "A" and "B" batteries.

AWARDED THE RADIO NEWS LABORATORIES CERTIFICATE OF MERIT NO. 774.

ERLA DIAL

The dial shown in the illustration was submitted by the Electrical Research Laboratories, 2500 Cottage Grove Ave., Chicago, Ill., to the RADIO NEWS LABORATORIES for test. This dial is made of pressed material

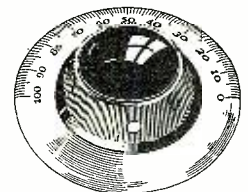

having a bakelite knob attached to it. It is well made, accurately divided and presents an attractive appearance on a panel.

AWARDED THE RADIO NEWS LABORATORIES CERTIFICATE OF MERIT NO. 784.

WORLD'S RECORD COILS

The coils shown in the illustration were submitted to the RADIO NEWS LABORATORIES for test by the World's Record Coil Company, 464 W. 6th



St., San Pedro, Calif. These coils are very simply made and arranged to be used in almost any kind of set. They will operate satisfactorily over the entire range of broadcast

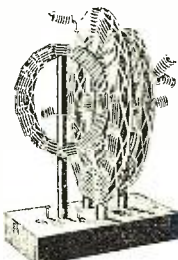

wave-lengths with the usual size condenser. They are wound in the usual basket fashion.

AWARDED THE RADIO NEWS LABORATORIES CERTIFICATE OF MERIT NO. 787.

ELRACO VARIABLE CONDENSER

This variable condenser, submitted to the RADIO NEWS LABORATORIES for test by the Elgin Radio Corporation, Elgin, Ill., has a maximum capacity of 87 micromicrofarads and a minimum capacity of 18 micromicrofarads. It is well constructed, having plates of brass, cut-out metal

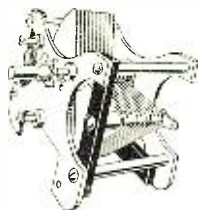

inplates and insulation strips of bakelite. Contact is made from the rotating shaft from the frame by means of a spring contact strip which rubs against the flat washer on the shaft. Bearing adjustments of a cone type are provided. There is also provision made for varying the tension of the spring strip making contact with the rotating shaft.

AWARDED THE RADIO NEWS LABORATORIES CERTIFICATE OF MERIT NO. 783.

ERLA RHEOSTAT

This rheostat furnished to the RADIO NEWS LABORATORIES for test by the Electrical Research Laboratories, 2500 Cottage Grove

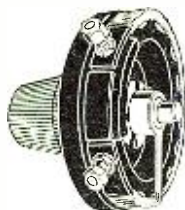

Ave., Chicago, Ill., had a maximum resistance of 6 ohms. It is rigidly built and can be used satisfactorily in any kind of radio receiving circuit.

AWARDED THE RADIO NEWS LABORATORIES CERTIFICATE OF MERIT NO. 789.

ERLA VARIABLE CONDENSER

This condenser, submitted to the RADIO NEWS LABORATORIES by the Electrical Research Laboratories, 2500 Cottage Grove Ave., Chicago, Ill., has a maximum capacity of 539

micromicrofarads and a minimum capacity of 24 micromicrofarads. It is well constructed, being made entirely of metal with the exception of insulation buttons which support the

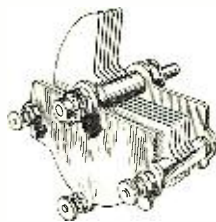

metal plates. The whole is nickel-plated and presents a very attractive appearance. It is very rigidly built.

AWARDED THE RADIO NEWS LABORATORIES CERTIFICATE OF MERIT NO. 793.

KEYSTONE VACUUM TUBE SOCKET

This vacuum tube socket, submitted to the RADIO NEWS LABORATORIES for test by the Keystone Radio Company, Greenville, Pa., is shown in the accompanying illustration. It is well made and possesses all the features desired in the vacuum tube



socket. The base is of molded bakelite and the collar of metal.

AWARDED THE RADIO NEWS LABORATORIES CERTIFICATE OF MERIT NO. 791.

GENERAL RADIO AUDIO FREQUENCY TRANSFORMER

This transformer, submitted by the General Radio Company, 11 Windsor St., Cambridge, Mass., to the RADIO NEWS LABORATORIES for test, is shown in the illustration. It is totally encased in metal, so that it is shielded effectively from audio interstage coupling. It possesses a very flat characteristic, so that very



fine reception can be obtained through the use of these transformers.

AWARDED THE RADIO NEWS LABORATORIES CERTIFICATE OF MERIT NO. 794.

OPERADIO VARIABLE CONDENSER

This variable condenser, submitted by the Operadio Company, 1476 Broadway, New York City, to the RADIO NEWS LABORATORIES for test, is constructed in a very rigid fashion and has thick plates of solid metal. The whole is encased in a secure sheet of celluloid, making it entirely dust-proof. The condenser is furnished with a vernier attachment

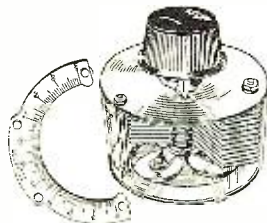

operated by the condenser knob. A calibrated metal arc which can be fastened on to the panel above the condenser pointer is also furnished. The maximum capacity is 458 micromicrofarads and the minimum is 424 micromicrofarads.

AWARDED THE RADIO NEWS LABORATORIES CERTIFICATE OF MERIT NO. 792.

EDELMAN'S SCREW-DRIVERS

This set of screw-drivers, furnished by E. Edelman & Co., 2362 Logan Blvd., Chicago, Ill., to the RADIO NEWS LABORATORIES for test, consists of four metal screw-drivers with telescopes fitting into one another. This makes a very convenient adjunct for the radio constructor, giving him various sizes of screw-drivers for the different con-

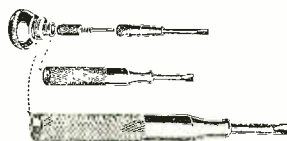

ditions which arise in radio construction.

AWARDED THE RADIO NEWS LABORATORIES CERTIFICATE OF MERIT NO. 795.

BOETTER FIXED CONDENSER

This fixed condenser, furnished to the RADIO NEWS LABORATORIES for test by the A. V. Boetter Mfg. Company, 612 S. Canal St., Chicago, Ill., has a rated capacity of 1/2 microfarad. It operates very satisfactorily as a large bypass condenser for different purposes and also in filter circuits

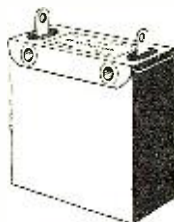

AWARDED THE RADIO NEWS LABORATORIES CERTIFICATE OF MERIT NO. 796.

DON-MAC PROTECT-O-TUBE

This tube protector is put up in cartridge form. It has a rheostat of



approximately 350 ohms and will effectively protect the tubes from blowing out in case of accidental application of the "B" voltage. Submitted to the RADIO NEWS LABORATORIES for test by the Don-Mac Company, 29 S. Desplains St., Chicago, Ill.

AWARDED THE RADIO NEWS LABORATORIES CERTIFICATE OF MERIT NO. 765.

RE-VI-VO "A" AND "B" BATTERIES

These batteries shown in the illustration are of exceptional construction and can be charged directly from direct current house-light-



ing systems, or through a lamp or an electrolytic rectifier from alternating house systems. They have been charged and discharged repeatedly in the RADIO NEWS LABORATORIES and still maintain their voltage and capacity. Submitted to the RADIO NEWS LABORATORIES for test by "Re-Vi-Vo" Inc., 40 West 20th Street, New York City.

AWARDED THE RADIO NEWS LABORATORIES CERTIFICATE OF MERIT NO. 800.

NAZLEY WINDING FORM

This winding form shown in the illustration was submitted for test to the RADIO NEWS LABORATORIES by the J. Nazley Company, 571 Hudson Street, N. Y. City. It is made of stamped insulation material and is suitable for winding spider-web coils.



AWARDED THE RADIO NEWS LABORATORIES CERTIFICATE OF MERIT NO. 801.

CARTER LOOP

This loop was submitted by the Carter Radio Company, 209 S. State St., Chicago, Ill., to the RADIO NEWS LABORATORIES for test. It is very admirably constructed and presents a very pleasing appearance. The winding is of the anti-capacity type and is tapped for various wave ranges. It can be used satisfactorily



to cover the broadcast range with the usual size of condenser.

AWARDED THE RADIO NEWS LABORATORIES CERTIFICATE OF MERIT NO. 802.

BOEHM VACUUM TUBE

This tube, type 401, operates under filament voltage of 5 or 6 and plates voltages from 16 to 100. Can be used very satisfactorily as an amplifier or detector. It has an amplification factor of about 7. Submitted by the Boehm Radio Company, 264 Canal Street, N. Y. C., to



the RADIO NEWS LABORATORIES for test.

AWARDED THE RADIO NEWS LABORATORIES CERTIFICATE OF MERIT NO. 807.

PERFECTION SUPERCOIL

This three-circuit tuner, furnished the RADIO NEWS LABORATORIES for test by the Perfection Radio Manufacturing Co., 24th and Race Sts., Philadelphia, Pa., consists of a primary, secondary and variable tickler and will operate satisfactorily over the broadcast range with a .0005 condenser. It is of the latticed type of winding, the primary and secondary being wound with No. 18 wire,

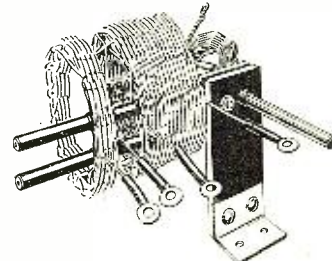

which makes the resistance comparatively low. The adjustment between the primary and secondary is variable.

AWARDED THE RADIO NEWS LABORATORIES CERTIFICATE OF MERIT NO. 799.

RECTIGON CHARGER

This charger, manufactured by the Westinghouse Electric & Mfg. Co., East Pittsburgh, Pa. is designed to charge both "A" and "B" batteries. The Rectigon Bulb in the charging circuit regulates the charging current.

AWARDED THE RADIO NEWS LABORATORIES CERTIFICATE OF MERIT NO. 775.

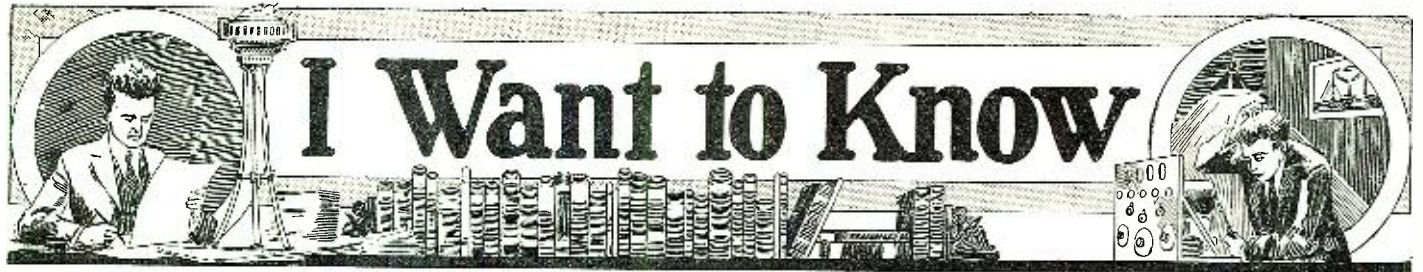

THIS Department is conducted for the benefit of our Radio Experimenter. We shall be glad to answer here questions for the benefit of all, but we can publish only such matter as is of sufficient interest to all.

1. This Department cannot answer more than three questions for each correspondent.
 2. Only one side of the sheet should be written upon; all matter should be typewritten or else written in ink. No attention paid to penciled matter.
 3. Sketches, diagrams, etc., must be on separate sheets. This Department does not answer questions by mail free of charge.
 4. Our Editors will be glad to answer any letter, at the rate of 25c for each question. If, however, questions entail considerable research work, intricate calculations, patent research, etc., a special charge will be made. Before we answer such questions, correspondents will be informed as to the price charge.
- You will do the Editor a personal favor if you will make your letter as brief as possible.

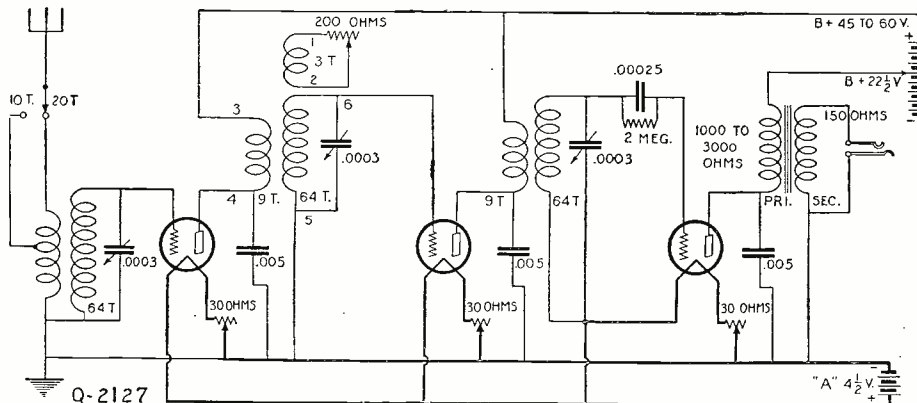

The "Airtrol," shown above, and the "Radio Knight" tuned radio frequency receivers both use the "absorption loss" method for preventing oscillation in such receivers. Varying the amount of loss, or absorption, of the circuit by means of a variable resistance makes it possible to adapt the set to any tubes and particular set conditions for maximum results.

MAGNAVOX ONE-DIAL SET

(2125) Mr. George A. Bell, Bethany, Mo., asks:
Q. 1. What is the circuit of the Magnavox one-dial receiver type TRF-5?

A. 1. The circuit of this and the type TRF-50 receiver is shown.
Condensers "C" are variable between .0001 and .00015 mfd. These are called "ratio" condensers. They are controlled by the three white porcelain knobs. When a distant station is being received, these three ratio condensers are varied until maximum signal strength is reached, and need not again be adjusted unless the set is moved or the tubes are changed.

When balancing the tuned circuits, it is advisable to make the adjustments while a low wave-length station is operating. If the variable ratio condensers are adjusted for a high wave-length station, there is a possibility of circuit oscillation when receiving stations at the shorter wave-lengths. The radio frequency choke may consist of 300

turns of No. 30 D.S.C. wire, wound on a 2-inch tube.

It will be noticed that no detector grid leak is used in the manufactured set. The experimenter may wish to use the customary grid leak from the detector grid to "A" plus. A variable one will be satisfactory.

Audio frequency transformers having a ratio of about 3:1 will probably be found best.

Variometer V-2 may be tapped at about 8 to 15 turns from one end of the stator winding, as shown, the exact number of turns being determined by experiment. Variometer V-3 may be tapped 5 to 10 turns from one end of the stator winding. The three variometers are mechanically arranged to be controlled by a single dial.

The 7-ohm rheostat is marked "Volume Control," and used in the following manner. With "Volume Control" at maximum, a whistling note is heard on tuning in a station. Turning "Volume Control" towards minimum, thus reducing the filament current of the first two radio frequency amplifier tubes, will now eliminate the whistle.

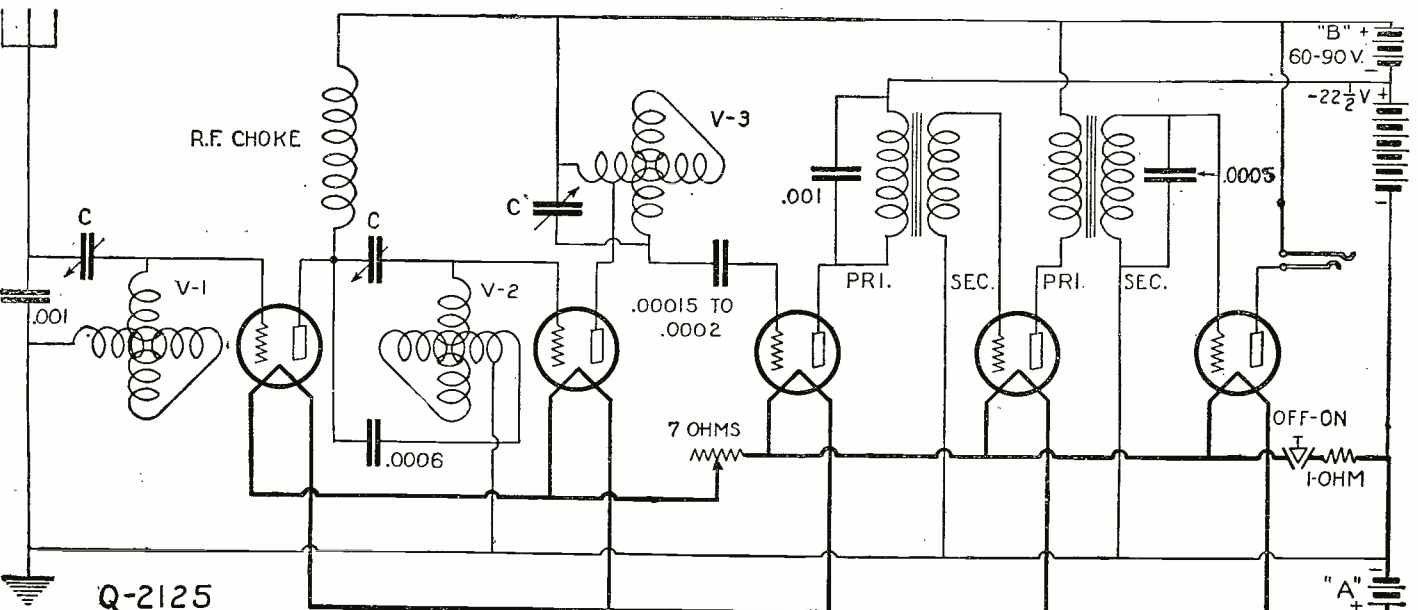

The Magnavox One-Dial Receiver has aroused considerable interest by reason of the excellent results that have been secured by its owners. Tiny, white knobs control the "ratio condensers" used to balance the circuits to the particular tubes and local conditions encountered.

OSCILLATION CONTROL

(2126) Mr. Manuel A. Smith, Plainfield, N. J., asks:
Q. 1. What is an "inherently neutralized" receiver?

A. 1. "Inherently neutralized" is an advertising phrase used in reference to receivers that will not oscillate, that employ tuned radio frequency amplification, but do not use any of the bridge methods of neutralization dependent upon the fundamental invention of Hazeltine. Such a receiver is the "Freshman," shown in the "I Want to Know" columns of the April, 1925, issue of RADIO NEWS. This receiver depends upon the "losser" method of oscillation control. Our illustration shows the Freshman coil arranged on the metal end-plate of its variable condenser in such a way as to be movable to and from the metal end-plate. (Observe how the coil may slide along the two insulating rods shown.)

If the receiver oscillates too strongly, one or more of the coils should be placed close to the metal end-plate of their respective variable condensers. The losses (called Foucault or eddy currents) developed in this end-plate are sufficient to prevent the circuit from oscillating.

Oscillation may also be prevented by placing a few turns of wire (between one and eight turns, depending upon individual requirements) in inductive relation to the secondary coils of the radio frequency transformers. These few turns are short-circuited and the loss produced by this "absorption" circuit is sufficient to prevent oscillation of the circuit. The practical application of this is found in the McColl circuit shown and described in the "I Want to Know" columns of the November, 1924, issue of RADIO NEWS (Q-2036). A suitable coil is shown in the answer to Q. 2127-A.

Other methods of oscillation control are explained in the article, "Oscillations and How They Are Overcome," by Leon L. Adelman, on page 2083 of the May, 1925, issue of RADIO NEWS, and also in the answers to other questions appearing in this issue.

Q. 2. Please describe the construction of a D-coil variometer. This type of variometer is used in the type TRF-5 single-dial receiver of Magnavox make.

A. 2. Complete construction data for D-shaped variometers will be found in the article by Mr. D. R. Clemons. This article will be found on

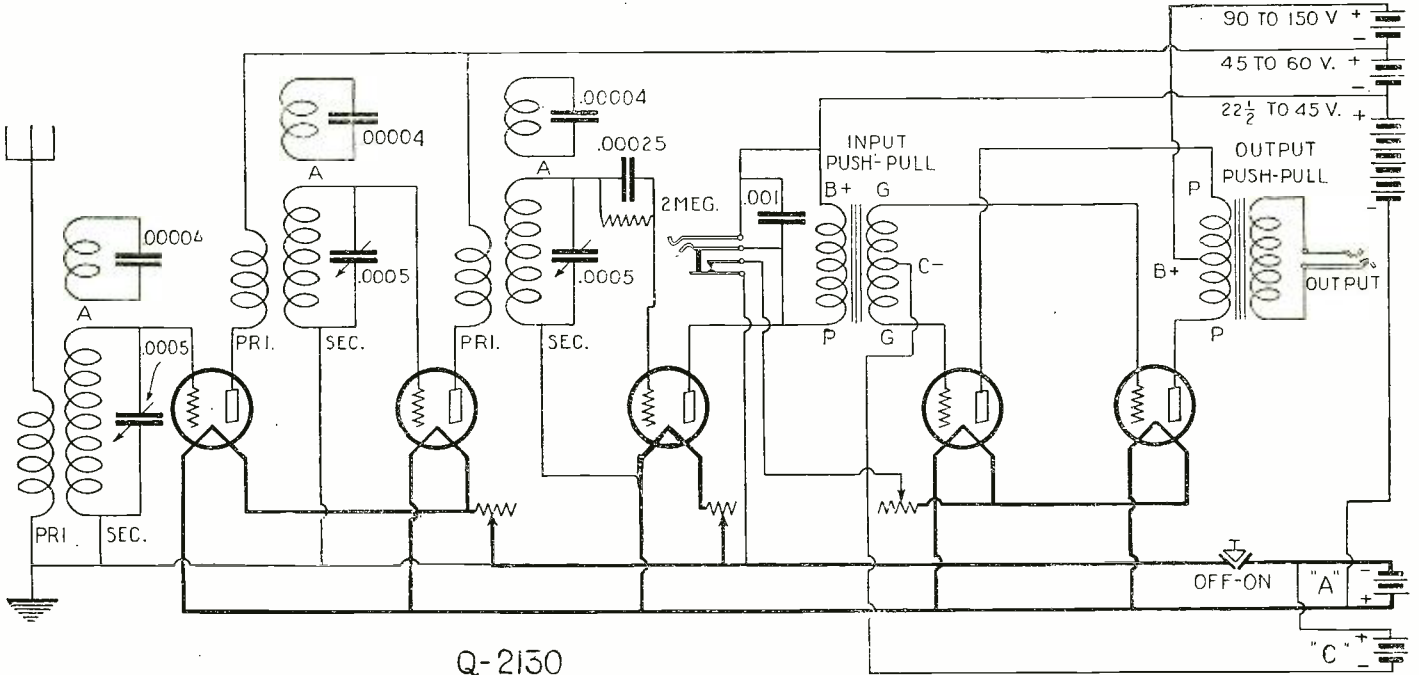

Q-2130

The Starr "tuned absorption" system for oscillation control in tuned radio frequency receivers. If small variable condensers, such as the new Turnit (they fit in the regular grid leak mounting) or the Amplex, are used to tune the absorption coil, an extremely flexible control is secured. The tuned radio frequency coils should be in non-inductive relation to one another, so that the loss necessarily created by coil "A" may be kept at a minimum.

page 206 of the June, 1923, issue of RADIO NEWS. Just how this particular construction form would operate in the Magnavox set we cannot state. The experimenter must determine exact values by trial.

AIRTROLA NON-OSCILLATING RECEIVER
(2127) Mr. Emil Johnson, La Crosse, Wis., asks:

Q. 1. Please show the schematic circuit of the Airtrola receiver. This uses an adjustment called the "Compentrol" for controlling oscillation.

A. 1. We are showing this circuit in these columns.

The "Compentrol" unit comprises the three-turn coil wound on the outside of the secondary and connected through the 200-ohm (or 400-ohm) variable resistance. A standard potentiometer may be used as these are obtainable in 200- and 400-ohm size.

The construction of the tuned radio frequency transformer containing this absorption coil is shown in the drawing marked "Q. 2127-A". The tuned radio frequency coils must be placed in non-inductive relation to one another. The winding having terminals one and two is the stabilizing coil. This set is being shown without the second stage of audio frequency amplification since this is standard.

These are not the most efficient form of inductance, solenoid coils (the type of coil made by winding a single layer of wire on an ordinary tube) being best from a "loss" standpoint, but this type of coil and the one marked "Q. 2126" are being used by radio set manufacturers to a great extent, because they do not have as strong an external field as solenoids, a fact which makes

it much easier to prevent coupling of the fields. If the fields couple, undesirable oscillation starts. Both coils require less space than solenoids. The one marked "Q. 2126" is a modified Lorenz winding.

Q. 2. Is it possible to use a transformer in such a way as to increase the response when a pair of ordinary 75-ohm receivers are used?

A. 2. We have shown, in the above circuit of the Airtrola, the requirements of a transformer to be used with a pair of head-phones having a total D.C. resistance of about 150 ohms—two 75-ohm receivers connected in series. If head-phones of standard high resistance (1,000 to 3,000 ohms) are used, they should be connected into the circuit in place of the 1,000- to 3,000-ohm primary of the transformer shown. The high resistance primary is adapted to the high resistance plate circuit and the low resistance secondary is adapted to the low resistance head-phones, resulting in efficient operation; the low resistance phones are not well adapted to vacuum tube plate circuits, unless this transformer-adaptor is used.

Also some circuits are extremely sensitive to the approach of the hand ("hand-capacity" or "body-capacity" effect). Using a transformer to insulate the phones from the plate circuit of the detector tube often eliminates or greatly reduces this effect. Of course, a high resistance secondary must be used if a pair of high resistance head-phones are being used.

A 1:0-1 telephone transformer of the high resistance primary, high resistance secondary type is advisable where phones of high resistance are being used. Often these are wound with very fine wire not capable of carrying the high amperage direct current that occasionally flows in the plate circuit. The transformer supplies the head-phones with alternating current of a lower amperage, thus preventing a burn-out. The transformer losses are compensated for by good design and the advantages derived.

The head-phones, or loud speaker, may also be insulated by means of a fixed condenser and an audio frequency choke coil, as shown in the diagram marked Q. 2088, appearing in the February, 1925, issue of RADIO NEWS in the "I Want to Know" department.

PICTURE DIAGRAMS

(2128) Mr. P. Cherubini, Rahway, N. J., says: Q. 1. Please show a picture diagram of a one-tube receiver that may be readily adapted to the standard radio receiving circuits now in general use.

A. 1. The picture diagram marked Q. 2128 shows how to connect a single tube in the form of a unit that makes it possible to try conveniently practically all of the more important circuits used in radio reception.

Any tubes may be used. It is best to use a storage "A" battery of six volts, with UV-201A, C-301A, Magnavox, DeForest or Schiekerling six-volt tubes. A 20- to 30-ohm rheostat may be used. If dry cell tubes of the UV-199 or C-399 type are used, three dry cells or two sections of a storage battery (four volts) may be used. Since these tubes require a special socket, it is necessary to use this socket, or else use an adaptor that will accommodate dry cell tubes to sockets designed for storage battery tubes. Regenerative circuits may be used to make extremely efficient receivers, even with dry cell tubes of the WD-11,

WD-12, C-11 and C-12 type, operating with a single dry cell or a single storage cell.

The single dry cell tube has made it possible for thousands of people to possess efficient radio sets that do not require rechargeable batteries. A single dry cell will operate a dry cell tube for a period of 90 to 100 hours. Since the dry cell costs less than 50c, the operating expense is very little. In estimating the cost, proper consideration must be given to the operating life and initial price of the vacuum tube and the "B" battery. Properly operated, the average life of the vacuum tube is about 1,500 hours, while the "B" battery is usually found to last from six months to a year, depending upon the make, size, demands and other factors.

One way of greatly lengthening the life of the tube is to use precaution in lighting the filament; remember, an increase of 10 per cent. in filament heat, beyond the rated heat, will decrease the life of the tube one-half!

The "B" battery, too, comes under consideration if one desires the least possible expense of maintenance. Heat accelerates the chemical action in "B" battery cells, so do not place the battery near a heater, or in the sun. "Keep in a cool, dry place." Never "short" the "B" battery for a fraction of a second to determine its worth for your set. Such a procedure has questionable value when the husky "A" battery is the victim.

The entire apparatus may be set up on a table, while various combinations of the instruments are tried. After it has been finally decided just what circuit and equipment will be used in the final receiver, a permanent lay-out and wiring may be planned.

"Test clips" soldered to short lengths of wire are now obtainable, making a change in the circuit merely a matter of seconds.

The make of apparatus is optional. A variable grid leak is recommended. The "B" battery volt-

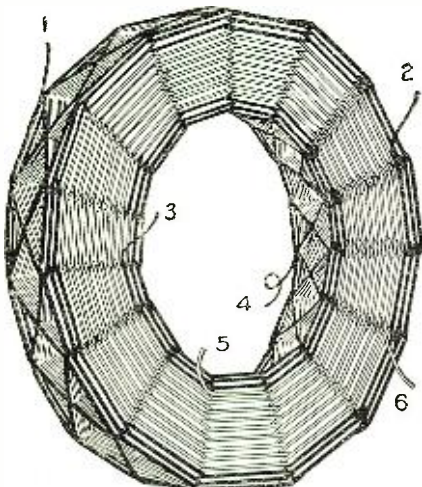

Q-2127-A

The "shorted turns" method of preventing oscillation in tuned radio frequency receivers is described in the text referring to this inductance coil.

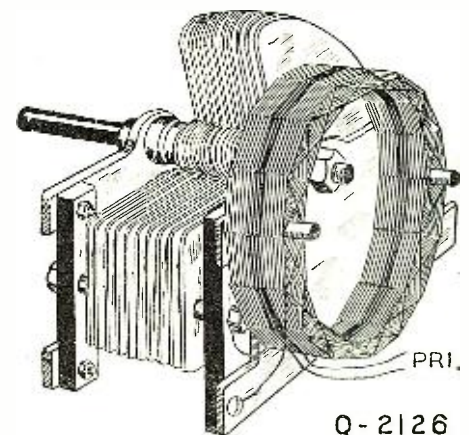

Q-2126

The Freshman "eddy currents" method of oscillation control. The inductance is placed sufficiently close to the condenser end-plate for the lines of force of the coil to cause eddy currents (a form of loss).

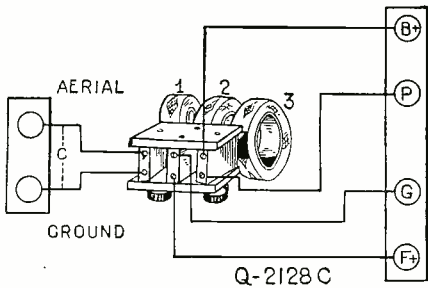

The "3-coil honeycomb" regenerative unit. The standard way of receiving long-wave stations.

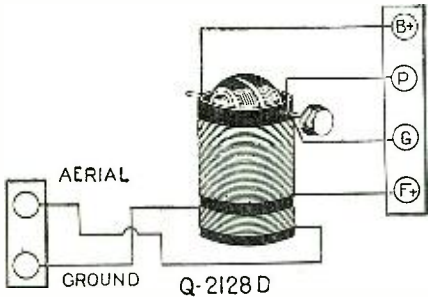

The "untuned primary" type of set. This is the standard regenerative circuit of today for broadcast reception.

age should be kept as low as possible, if the greatest sensitivity is desired. Changing the "B" battery voltage necessitates a new value for the grid leak, hence the suggestion of a variable leak of "noiseless" type. (A poorly-made leak will constantly change in its resistance, resulting in crackling sounds and generally poor reception). The grid condenser and the phone condenser must also have the feature of "noiselessness." Poorly-made paper- or mica-insulated condensers permit a partial, intermittent current leakage that also results in crackling sounds—or total inoperation. A "B" battery containing one or more "dead" or inactive cells, an "A" battery in need of recharging, and vacuum tube sockets of poor construction can also cause crackling sounds or total inoperation.

Phone cords partly broken will cause crackling sounds. Shaking the cord will quickly check this possibility.

To return to battery voltages—we wish to state that 22½ volts is the usual plate potential for all detector tubes. If the regenerative circuit will not oscillate with this potential, it may be necessary to increase the voltage to 40 or 50. Beyond this it is not advisable to go, as sensitivity is then greatly decreased. If there is thought to be sufficient inductance in the plate circuit, and the circuit refuses to "perk," even with a phone condenser and a reversal of the tickler leads, try another tube; the non-oscillation may be due to too high a vacuum or too little emission of electrons from the filament. We have not suggested a reversal of the "A" battery leads as a way of assisting oscillation, since such a connection ("B" minus to "A" minus) has the

effect of reducing the "B" battery voltage, which was not what we desired to do in the instance given.

The first of four standard regenerative circuits we intend to show in picture form is the one-time "standard,"

2-Variometer, Variocoupler Diagram.

This circuit requires five controls, two for the two variometers (V-1 and V-2), one for the variocoupler rotor and two for the switches. The grid lead of diagram Q. 2128 must be broken at X and connected to the two X leads of grid variometer V-1 (Q. 2128-A).

Although the switches are marked "units" and "tens," there are only seven leads shown connecting to each switch. Some variocouplers have a total of 14 taps and others have a total of 20 taps. The "units" switch has a tap taken at every turn for the first seven (or ten) turns. The "tens" switch has a tap taken at every seven (or ten) turns, for 49 (or 100) turns. If the units-and-sevens tapping arrangement is used there will be a total of 56 turns—110 turns if the units-and-tens systems is followed. Either will be satisfactory.

With the tapped primary of the variocoupler V. C. connected to a well-insulated copper aerial in one piece, and a good ground connection made to a well-scraped cold water pipe or a five-foot iron rod driven into moist earth, and the four binding-posts of the tube unit connected to the four binding-posts of the tuning unit, one has a complete receiving set.

Plate circuit variometer V-2 controls range, selectivity and volume. (Or, in one word, regeneration.) The rotating secondary of the variocoupler also assists in sharpening the tuning, maximum selectivity being obtained when the rotor is placed at "loosest coupling," the position shown in the diagram. Reversing the connections of plate variometer V-2 sometimes improves the reception.

If it is desired to have the set operate as a plain detector, without the regenerative feature afforded by the plate variometer, this instrument may be put out of operation by short-circuiting it by means of the shorting wire marked "jumper."

Note that the .0005 mfd. variable condenser is not required if variometers are used to tune the grid and plate circuits of this set in the manner illustrated. The variometer is known as a "continuously variable inductance" and no other means of changing the wave-length is needed.

If the variocoupler rotor contains sufficient wire, the .0005 mfd. variable condenser may be used to tune the grid circuit. Grid tuning variometer V-1 is then not needed.

2-Coil Variocoupler Diagram

The variocoupler described above may be used in constructing an effective receiver that does not require variometers. A lead from one end of the variocoupler tapped primary connects to binding-post "G." The other end of the primary connects to binding-post "F+." The variable condenser tunes the grid circuit so formed. The plate circuit is not tuned, as previously. "Regeneration" is controlled by means of the "tickler feed-back" supplied by the rotor.

If the primary leads are not securely fastened to the switch-points and the primary coil, there can be no reception of signals when the switch lever makes contact with the poorly connected taps.

As stated previously, minimum coupling is secured when the rotor is situated as shown. Maximum coupling is 90 degrees to either side of this position. Some variocouplers are of the "180 degree" type. With these, maximum coupling is

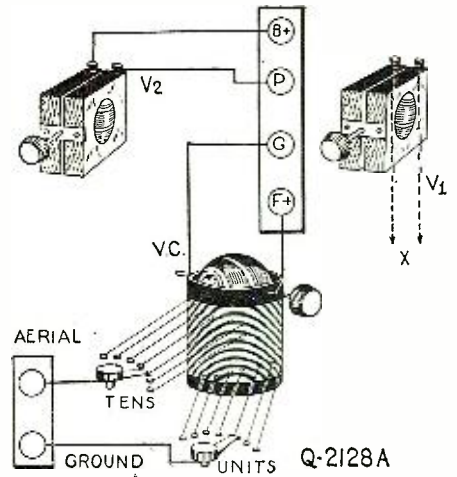

The "2-variometer, variocoupler" regenerative arrangement. This was once the standard of reception circuits, but a demand for simplicity of control forced the "untuned primary" receiver into the lead.

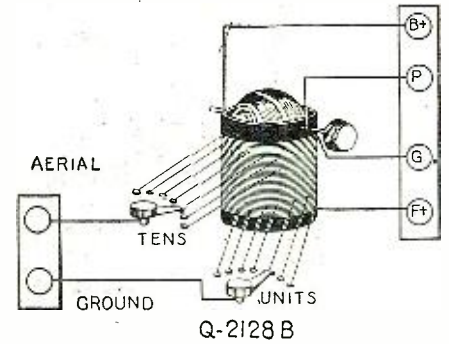

The "2-coil variocoupler with tapped primary" unit. This is submitted for those who wish to construct the simple 2-coil variocoupler regenerative circuit.

in a position 180 degrees from the minimum coupling position of the rotor. Most of the 180-degree variocouplers have a stop that limits the amount of motion to 180 degrees. It is advisable to try reversing the rotor connections if such a coupler is used, in order to determine the best connection.

This is the most broadly-tuning circuit of the four, but if the set is situated some distance from powerful broadcasting stations, this objection is not serious.

The three circuits using variocouplers are all limited to the wave-length range to which the couplers will respond. This is usually about 200 to 575 meters. It is occasionally desirable to receive stations operating on wave-lengths as high as 30,000 meters. A few of the foreign broadcast stations operate on 2,000 and 3,000 meters. The most practical circuit for receiving all wave-lengths is the

3-Honeycomb Circuit

Circuit Q. 2128-C shows a standard 3-coil honeycomb mounting containing primary coil 1, secondary coil 2, and tickler coil 3. The size of these honeycombs will be found to be very nearly the same for a given wave-length range. A table showing the coil sizes for a given range will be found in the "I Want to Know" department of the January, 1925, issue of RADIO NEWS, page 1229.

In using the honeycomb reception system, it will be found necessary to employ a variable condenser connected from aerial to ground, as indicated by the dotted line and the letter "C." This condenser may have a maximum capacity of .0005 or .001 mfd.

The flexibility of wave-length change afforded by the plug-in system may be extended to include "spider-web" coils wound on flat, slotted forms. Efficient reception is possible on 25 and 50 meters with the use of suitable spider-web coils.

Untuned Primary Receiver

Diagram Q. 2128-D illustrates the type of regenerative receiver most commonly used at the present time; it owes its popularity to its high selectivity, high sensitivity and ease of control. Only one dial is required for the variable condenser wave-length control and one dial for the tickler feed-back amplification control. It has been found (see the articles by Sylvan Harris in the February and March, 1925, issues of RADIO NEWS) that variable condenser losses are of less importance than inductance losses and, for that reason, one should take exceptional care to see that the coils used are of low-loss construction. The circuit using this form of coil has been heralded under a hundred aliases, its outstanding

(Continued on page 119)

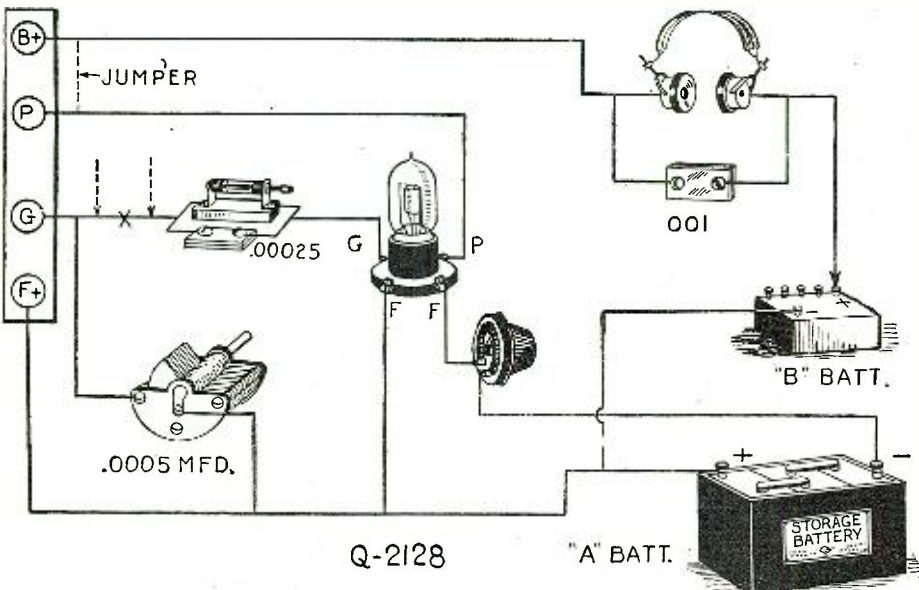

This picture diagram of a tube unit and the diagram of one of the coil units shown above, should enable anyone to construct a very efficient 1-tube receiver. The completed set may be later enlarged to include audio frequency amplification if the owner desires to operate a loud speaker.

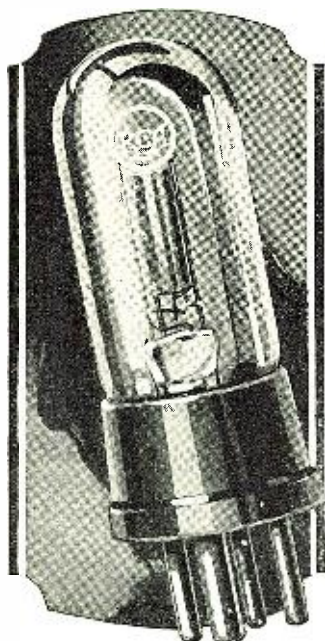

- WD-11
- WD-12
- UV-199
- UV-200
- UV-201-a

Radiotrons with these model numbers are only genuine when they bear the name Radiotron and the RCA mark.

Do you believe in Names?

Do you buy things by name because the name tells the quality? Do you ask for a RADIOTRON, instead of just a "vacuum tube" — demand the standard by the name that marks it as genuine?

The most important part of a radio set is the tube, and you can't get the best out of any set without putting the best tubes into it. There's a Radiotron for every use, in every kind of set. Look for the name—and the RCA mark. And be sure it is *genuine*.

Radio Corporation of America
Sales Offices: Suite No. 27

233 Broadway, New York

10 So. La Salle St., Chicago, Ill.

28 Geary Street, San Francisco, Cal.

Radiotron

REG. U.S. PAT. OFF.

PRODUCED ONLY BY RCA



Better Contact

An easy way to get distant stations clearly

IT'S important at all times—but doubly important in summer when static is apt to be troublesome — to have clean, perfect contact between tubes and sockets. If you don't, the almost unnoticeable films of corrosion act as barriers for the delicate current; magnified, they cause annoying noises.



Na-Ald Socket No. 499, 50c.



Na-Ald Adapter No. 429, 75c.

"It's the contact that counts"

Na-Ald Sockets remove those barriers. The exclusive side-scraping contacts (not just side pressure) of Na-Ald De Luxe Sockets cut the corrosion from the sides of tube terminals. A turn or two of the tube—and the tube terminals are clean.

The Alden-processed Bakelite conserves all the current energy. Laboratory tests proved Na-Ald Sockets most efficient in low loss and low capacity.

Na-Ald Adapter No. 429 and Na-Ald Socket 499 are especially made for use with UV-199 and C-299, and No. 411 for WD-11 tubes all of which are used with dry batteries. They are a big aid to the highest tube efficiency.



Na-Ald De Luxe Socket No. 400, 75c.



Na-Ald Small Space Socket No. 401, 35c.



Na-Ald Socket No. 411, 75c.

Also makers of the famous Na-Ald Dials

ALDEN MANUFACTURING COMPANY
Dept. K8,
Springfield, Mass.



ALDEN MANUFACTURING CO.,
Dept. K8, Springfield, Mass.

Send me free booklet, "What to Build."

Name

Address

A 40-Meter Transmitter with a Punch

(Continued from page 68)

Do not use an antenna with a fundamental over 60 or 70 meters. I have found from experience that a single wire antenna and a single wire counterpoise or even a small cage counterpoise works best. It seems that a single wire antenna is not affected by surrounding objects as much as the large flat top. Try a single wire about 40 to 50 feet long; that is, from the open end to the apparatus and a single wire counterpoise the same length and about 5 feet above the earth. If you cannot tune to resonance, cut down the length until you can. No rules can be given for the proper size, as the fundamental of the antenna will vary in different localities due to surrounding objects.

INSULATORS

For insulators, use glass towel racks which can be purchased in almost any hardware store for about twenty-five cents. The method of connecting them is shown herewith. They stand up very well, considering the price.

The antenna and counterpoise lead-in wires are brought to small porcelain cone insulators, the same type as used to mount the condensers and are fastened to a board on the window sill. Sketch shown herewith. I am using this type of lead-in insulator in preference to the large moulded ones.

The 40-meter band is a very good one for daylight transmission, and this may interest us now that the days are getting longer. Stations 700 miles away can be worked consistently at noon. It was the general impression among some amateurs that 40-meter transmission was useless after darkness, but this has been proved untrue for this station. However, about one hour after sunset in Brooklyn it is impossible to hear stations in New England, while stations 800 to 1200 miles west are easily readable. My best distance west was 6 T S at Santa Monica, Calif., which was, I believe, the first time two amateurs on either side of the country were in communication on 40 meters. This is now being done every day. Every United States district has been worked on 40 meters with this set, and in almost every instance it was daylight at the other end. 6 T S was worked three hours after sunset in Brooklyn which meant sunset in California, but after working for about one hour and a half his signals faded away and I understand that mine did the same. I have heard 40-meter signals from stations 1200 miles away as late as 6 hours after sunset here, which shows that 40-meter transmission is not entirely killed by darkness. It may be that we will be able to work great distances, say, 5,000 to 10,000 miles, when the sun is about halfway between the two stations.

ANTENNA LOCATION

My antenna is located on the roof of a three-story brick building 40 feet high, the poles being 18 feet high. The antenna consists of a single wire No. 14 enameled, 50 feet long with a lead-in taken from the center and brought down 35 feet to a window on the second floor. The counterpoise is a single 2-inch cage of four wires only 18 feet long and the lead-in of the same type brought up to the window. The whole counterpoise and part of the lead-in of the antenna is surrounded on all sides by the building. The counterpoise happens to be in a small courtyard 20 by 20 feet. The roof is covered with tin and there is a metal skylight about ten feet high running parallel

LOOK HERE FOR THE RED STRIPE

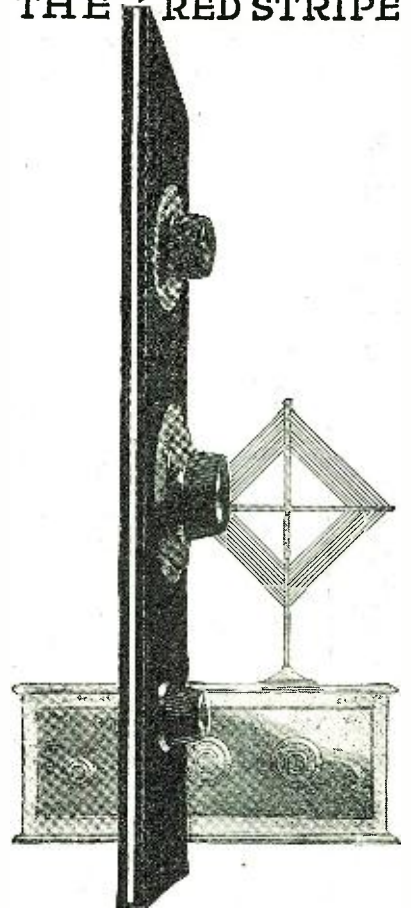

Used by the United States Navy and Signal Corps for over nine years. Dilecto is the strongest, safest radio panel that can be made. Look for the identifying "Red Stripe" that sets apart Dilecto from its imitators.

THE CONTINENTAL FIBRE CO.
FACTORY: NEWARK, DELAWARE

Service on Dilecto, also Contex, Conite, and Vulcanized Fibre, from:

NEW YORK 250 Park Ave.	SAN FRANCISCO 75 Fremont St.
CHICAGO Wrigley Bldg.	SEATTLE 1041 6th Ave., So.
PITTSBURGH Farmers Bank Bldg.	LOS ANGELES 307 So. Hill St.

Offices and Agents Throughout the World

Dilecto

(distinguished by its red stripe)

RADIO K Catalog

TELLS HOW to assemble your own radio set without the bus-bar-and-solder nuisance. HOW to get your own radio kit and accessories without charge. HOW to go into business for yourself and build sets our easy "No-Sol-er" way for your friends and neighbors. Everything Explained. Contains offers of kits for large number of the best radio receivers, at lowest prices. Highest quality parts. (Please see our big ad., page 12.)

Goods Shipped on Approval—No Money in Advance—Quick Shipment—We Pay the Transportation—Satisfaction or Money Back

RADIO SPECIALTY COMPANY
Kit Div. 679C, 245 Greenwich St., New York City

BOSCH NOBATTERY
The Bosch NoBattery is a device which enables anyone to obtain from an electric light socket perfect and ample plate voltage for radio vacuum tubes. It takes the place of all "B" batteries and is decidedly more efficient, reliable, convenient and economical—correspondence invited.
AMER. BOSCH MAGNETO CORP., Springfield, Mass.

**EVEREADY HOUR
EVERY TUESDAY AT 8 P. M.**
(Eastern Standard Time)

For real radio enjoyment tune in the "Eveready Group." Broadcast through stations—

WEAF New York	WEAR Cleveland
WJAR Providence	WSAI Cincinnati
WEEI Boston	WWJ Detroit
WFI Philadelphia	WCCO Minneapolis
WGR Buffalo	WOC St. Paul
WCAE Pittsburgh	WOC Davenport

Get a good set— and Evereadys

To ENJOY radio for the rest of your life, get the best set you can afford. There are receivers at all prices, made by reputable manufacturers; it isn't necessary for anyone to get 'round-the-corner, unproved, unreliable merchandise at any price. That applies to batteries too. Eveready Radio Batteries are made in so many sizes and prices that there is a correct, long-lasting Eveready for every receiver and for every radio home, ship or commercial station. Specify Evereadys for your new radio set. It is false economy to buy nondescript batteries at any time. In the long run you'll find it most economical to buy either the large or extra large Evereadys. Always buy Evereadys and enjoy the knowledge that no one can get any more in batteries for the money than you. There is an Eveready dealer nearby.

Manufactured and guaranteed by

NATIONAL CARBON CO., INC.
New York San Francisco
Canadian National Carbon Co., Limited, Toronto, Ontario

EVEREADY Radio Batteries

-they last longer

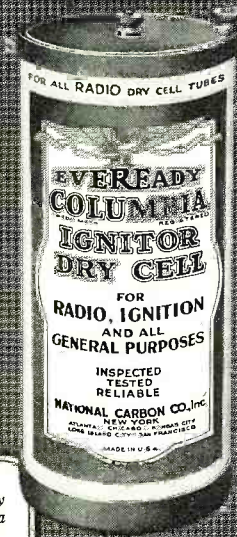

Eveready Columbia Ignitor the proven Dry Cell for all Radio Dry Cell Tubes 1½ volts

No. 766
22½-volt
Large
Horizontal
Price \$2.00

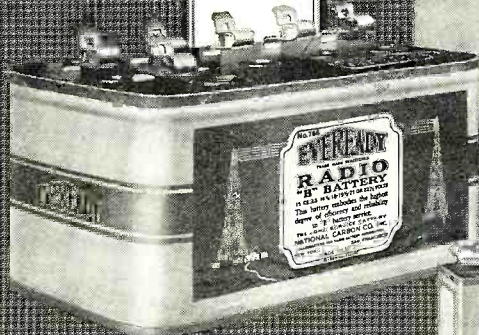

No. 772
45-volt
Large
Vertical
Price \$3.75



No. 771
4½-volt
"C"
Battery improves quality, saves "B" Batteries
Price 60c

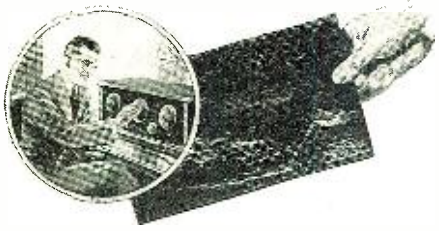

A safeguard against current leakage

THOSE faint electrical impulses picked out of the ether by your antennae must be led along through the circuit of your set with the least possible chance of escape. To guard this path is the prime function of insulation.

Any leakage due to poor insulation has a marked effect on the character and volume of the current delivered to the phone or loud speaker. The insulating material proved most efficient in guarding against such leakage is Radion.

Radion was built to order exclusively for radio. Compared with all commercial insulations offered for radio it has:

- (1) Lowest angle phase difference.
- (2) Lowest dielectric constant.
- (3) Highest resistivity.
- (4) Lowest moisture absorption.
- (5) Lowest power factor loss.

Radion Panels are the easiest to work with simple home tools and are regarded as the best-looking, best-finished panels made. There are 18 standard sizes in black and mahogany. Radion Dials (in all regular sizes) match Radion Panels.

Radion Panels and Dials cost no more—in many cases, less—than materials having inferior electrical characteristics.

Send for booklet "Building Your Own Set". It contains complete, clear directions for building the most popular circuits; gives wiring diagrams, front and rear views, shows a new set with slanting panel, etc. Mailed for ten cents. Use coupon.

AMERICAN HARD RUBBER CO.
Dept. A-7, 11 Mercer St., N. Y. City

RADION

The Supreme Insulation
PANELS

Dials, Sockets, Binding Post Panels, etc.



AMERICAN HARD RUBBER COMPANY
Dept. A-7, 11 Mercer St., New York.
Please send me your booklet, "Building Your Own Set" for which I enclose 10c.

Name
Address

with the flat top about four feet away. So you can readily see what can be done on the short waves with a poor antenna. The antenna current on 40 meters is only 1/10 of an ampere with an input of 95 watts. The low antenna current is due to the fact that the antenna is being worked far below its fundamental, which is 75 meters. With the same circuit and antenna but operating on 77 meters, using a separate set of inductances consisting of 12 turns each and 6 inches in diameter with the same type condensers as described for 40-meter work, I have been in communication with 60 West Coast stations, England, France, Holland and Italy, and have been heard in almost every European country. Brazil has also been worked on 77 meters.

If you wish to work both the 75-meter and 40-meter band, it would be a good idea to mount both sets of inductances on small baseboards, so that they can be interchanged quickly, the only connections being made are the grid, plate, negative high voltage, antenna and counterpoise. I use clips on these five connections so that it is possible for me to change from 75 to 40 meters within less than a minute. The lower down we go on our wave, the less the interference between ourselves and the broadcast listener. On 20 and 40 meters there should be no interference at all. This also applies to 75-meter transmission, if the plate supply is properly rectified and filtered.

By tuning the oscillator down lower and making a smaller antenna, you can work the 20-meter band. This is a daylight band only. At this station I have worked stations 1200 miles away at noon on 20.5 meters, which certainly is good DX as compared with our old 150-meter wave.

Radio Wrinkles

(Continued from page 69)

pins' positions. Binding posts are used for fastening the pins to the bakelite base.

The prong connections in this socket are excellent and there is a small amount of insulating material near the tube, reducing the socket capacity to a great extent. All spring pressures are so arranged that possible damage to the tube and socket is avoided.

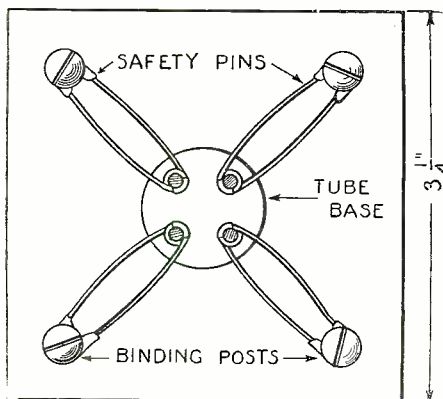

Four safety-pins, four bolts, and a 3/4-inch square of bakelite make an efficient socket.

If it is desired to change tubes when using this socket it is better to disconnect the leads from the binding posts and change the entire socket. One advantage of this socket is its low cost.

Contributed by R. T. Pound.

SO DO THE REST

Ned: "You believe your receiver to be the best in town?"

Ed: "Yes—why, I even admit it!"

Contributed by Jack Bront.

Only 75 Motors

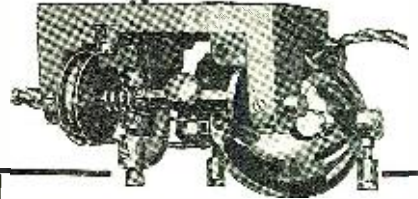

Left at \$10 Each

Ideal for home-made phonographs, experimental purposes and combination PHONOGRAPH-RADIO sets.

We have 75 small motors which are greatly under-priced for quick clearance. You will never again equal this low price, when this lot is sold.

They are universal motors, 110 volts, 60 cycle single phase, complete with turntable, cord and socket for immediate use. 1400 R. P. M. Motor has 1" pulley with flange for 3/4" flat belt. Housed in highly polished, nickel-plated shell.

Don't lose out on this remarkable offer. Order your motor today. Tomorrow may be too late. DO IT NOW! Price \$10.00 f. o. b. Steger, Illinois.

Industrial Division

Steger & Sons

Piano Manufacturing Company

Dept. 60, Steger Building CHICAGO, ILLINOIS

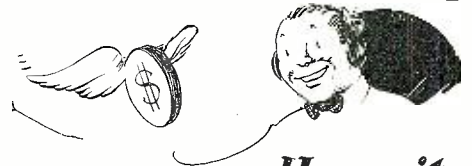

Here it is!
listen!

Hommel Broadcasting:

Business static hurts your cash register as much as weather static hurts reception.

Now, listen in carefully.

The HOMMEL Dealer Service Department was developed for the one particular purpose to help alleviate business "static." That Department is vitally concerned in furthering your interests—as a Hommel Dealer.

We work shoulder to shoulder with our dealers—not in competition with them. We wholesale only and carry only the most reputable radio equipment. All user inquiries and orders resulting from our national advertising are forwarded promptly to our local dealer.

We can't help you unless you ask us to. Write today for Hommel's Encyclopedia of Radio Apparatus 266-S. It's free and will help you.

WHOLESALE EXCLUSIVELY
LUDWIG HOMMEL & CO.
929 PENN AVENUE PITTSBURGH, PA.

The "LINCOLN"

Enclosed Fixed Adjustable Detector
Kills your Reflex Troubles

New List Price \$1.50

Manufactured by LINCOLN MFG. CO.

Dept. E. I.
Los Angeles, Cal.

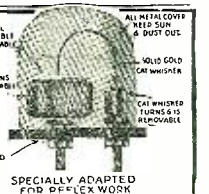

SPECIALLY ADAPTED FOR REFLEX WORK

HEATH CONDENSERS

For Real Radio Reception

Write for Literature

HEATH RADIO & ELECTRIC MFG. CO.,
206 First St., Newark, N. J.

Balkite Battery Charger.
Charges 6-volt "A" storage
batteries.

Price \$19.50
West of Rockies, \$20
In Canada, \$27.50

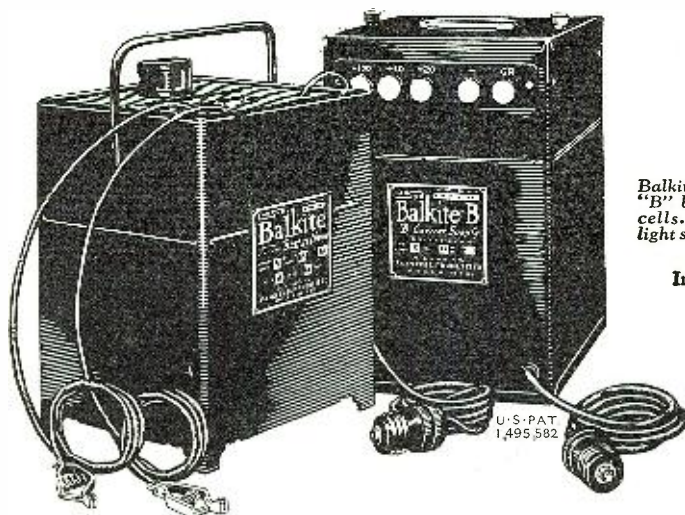

Balkite "B"—replaces
"B" batteries and dry
cells. Operates from
light socket.

Price \$55
In Canada, \$75

Balkite Radio Power Units

*give your set greater clarity,
distance and volume*

Your radio set will perform consistently only if your power supply is unfailing. Balkite Radio Power Units provide a convenient power supply that furnishes a constant, uniform voltage to both "A" and "B" circuits. The Balkite Charger keeps your "A" storage battery charged and operating at full efficiency. Balkite "B" replaces both "B" storage batteries and dry cells, and supplies plate current from the light socket.

The Balkite Battery Charger

and Balkite "B" are based on the same principle. Both are entirely noiseless in operation, have no moving parts or bulbs, have nothing to adjust, break or get out of order. They do not create disturbances in either your set or your neighbor's, require practically no attention, and can be put in operation at any time by merely connecting to the light socket. Their current consumption is very low. Both are guaranteed to give satisfaction.

Sold by leading radio dealers everywhere

FANSTEEL
Balkite *Radio Power Units*

BALKITE BATTERY CHARGER—BALKITE "B" PLATE CURRENT SUPPLY

Manufactured by FANSTEEL PRODUCTS COMPANY, Inc., North Chicago, Ill.



No. 22—About 1-3 actual size.

Safeguard your batteries

Where you find a radio fan getting the most out of his set—you'll also find a dependable battery measuring instrument. Nagel Voltmeters and Voltmeters are not only accurate in readings but their high resistance—60 ohms per volt—is a protection against battery drainage.

Obtainable at most reliable radio stores. If your dealer cannot supply you, address your inquiry direct to the manufacturer—The W. G. Nagel Electric Company, Hamilton Street, Toledo, Ohio, makers of the well-known Nagel automobile measuring instruments.



NAGEL

Manufacturers of
**DRY CELL TESTERS • AMMETERS
 HIGH-RESISTANCE VOLTMETERS
 and VOLTAMMETERS • BAKELITE
 HOT MOULDED INSULATIONS**

BUILDING A SET?

You must have rheostats of correct ohmage. Insist on the genuine



KLOSNER RHEOSTATS

Made by pioneer makers of the vernier. FREE.—Send for valuable Rheostat Chart and information on the care and operation of vacuum tubes. Mention dealer's name.

KLOSNER RADIO CORPORATION
 1024 East 178th St. Rheostat Specialists, N. Y. C.

PATENTS

C. L. PARKER
 Formerly Member
 Examining Corps,
 U.S. Patent Office.
 PATENT - LAWYER
 McGill Bldg., Wash., D. C.

Patents, Trade Marks, Copyrights, Patent Litigation
 Handbook for Inventors, "Protecting, Exploiting
 and Selling Inventions." sent upon request.

Four Phone Plugs and Posts
 Lightning Arresters and Switches of Merit
 Write for bulletins
THE BARKELEW ELECTRIC MFG. CO.
 Middletown, Ohio, U. S. A.

"The Thermion" Vacuumless Tube

(Continued from page 19)

about 2,000 hours under normal conditions, burning out of which is due only to disintegration from emission. As has been said before, it can be replaced at a nominal cost by means of small set screws located on the filament leads.

Both the grid and plate elements are of spiral construction and are made of a special non-oxidizing material, which will not oxidize in open air at temperatures up to 2,000 degrees. Due to the peculiar character of this material and its ability to resist oxidation, it can readily be appreciated that these elements will last indefinitely. This is a highly important point in the construction of tubes operating at air pressure, as a material that will not oxidize will not disintegrate.

A DEMONSTRATION

With this form of open work construction it will also be appreciated that it is a simple matter to construct tubes having various shaped grids and plates, using various spacing between the elements and leads. Because of this, it is possible to construct a tube having the lowest conceivable capacity, making the tube with a capacity of one micro-microfarad little more than a mere dream.

The writer recently witnessed a demonstration of the Thermion at the Hotel Commodore, New York City, given by Mr. Myers. Truly, it was an uncanny sensation to sit there and hear radio programs through a tube the filament of which was exposed . . . almost tempting one to light a cigar from it. This particular "tube," if we are permitted to call it such, had an 80-volt filament which was connected directly to the 110-volt direct current lighting circuit without filter of any sort. "It will operate," said Mr. Myers, "just as well on A.C." A large laboratory type of rheostat was used for filament contact. It is possible to construct a filament to accommodate 110 volts in its 5/8-inch length just as easily as to construct one for operation from a six-volt storage battery source, this being merely a matter of changing the density of the material used in the filament.

With the tube on demonstration the current consumption was slightly less than one-half ampere, and gave a space reading of one milliamperes at a 45-volt plate potential, increasing as the plate potential is increased as is customary with the usual vacuum tube.

It takes between 15 to 20 seconds for the filament to become active, if it is cold at the time the current is turned on, this sluggishness being due to its high resistance. If, after the tube has been operating, one blows strongly on its emitter rod, it is seen to dim somewhat with a decrease in signal strength. This chilling of the emitter rod, explained Myers, changes its temperature in the neighborhood of 800 degrees, enough to decrease emission, although this can be compensated for by increasing the rheostat.

CHARACTERISTICS

Several weeks previous to this, demonstration and experiments were conducted at Cruft's Laboratory at Harvard University. Two assistants of Professor Pierce took measurements and characteristics of the tube. It was found that the plate to filament resistance measured 65,000 ohms and the grid to filament 4,000 ohms, this latter measurement being taken with the tube acting as a Fleming valve, using the grid as the anode. This tube showed an amplification factor of 14. During these tests signals

ANTENNELLA

No Aerial or Antenna Needed

The Complete Efficient and Economical Aerial



Why pay \$10 Only \$1.25

or more to have an aerial spoil the appearance of your home? Antennella eliminates all unsightly wiring, lightning arresters, etc., and precludes the possibility of dangerous grounding on a power line. It also stops "canary bird" re-radiation from nearby oscillating sets interfering.

ANTENNELLA

is not only a real distance getter, but also overcomes troublesome static.

At your Dealer, otherwise send purchase price and you will be supplied postpaid.

Chas. Freshman Co. Inc.
 Radio Receivers and Parts
 FRESHMAN BUILDING
 240-248 WEST 40TH ST - NEW YORK, N.Y.



At your dealer \$1.25

TUNES-IN

Hard-to-get-stations
 THOSE elusive distant stations so often missed when tuning with ordinary dials are quickly, easily and clearly tuned-in by means of the



WALBERT MFG. CO., CHICAGO

BLUEBIRD RADIO TUBES

Distinctly New and Efficient

A quality tube at a moderate price, made possible by our direct sales plan. "Bluebird" is sensitive and powerful—produces clear volume.

- WITH BAKELITE BASE
- Type 400—5 Volts, 1 Ampere Detector Tube.
- Type 401A—5 Volts, .25 Ampere Amplifier and Detector.
- Type 499—3-4 Volts, .06 Ampere Amplifier and Detector.
- Type 499A—3/4 Volt, .06 Ampere With Standard Base.
- Type 412—1 1/2 Volts, .25 Ampere Platinum Filament, Amplifier and Detector. \$2.00
- All Standard Types.....
- Type 422, 5 Watt Transmitter \$3

ALL TUBES GUARANTEED to work in Radio Frequency. Especially adapted for Neutrodyne, Reflex and Super-Heterodyne Sets. When ordering mention tube.

BLUEBIRD TUBE CO. Dept. N
 200 Broadway New York City



Shipped Parcel Post C. O. D.

Midsummernight's Entertainment

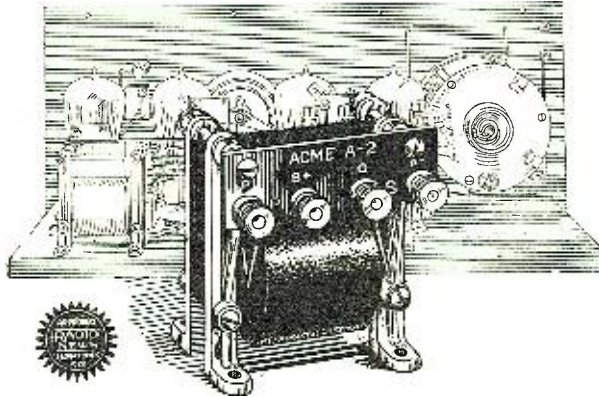

Loud and Clear with ACME Transformers

SOMEWHERE there's a comfortable chair on a comfortable porch. The heat of the day is over. Through the soft darkness a cool little breeze of evening is faintly rustling the leaves of the maple at the corner. In the depths of the chair, the end of a cigar fitfully glows. Out through the open window floats clear radio music; the romantic strains of La Paloma, or the Tales of Hoffman. There is deep content in the soul of the man in that chair, surrounded by the loneliness of the night and the soothing beauty of music brought to him by radio.

Whether you have a neutrodyne, superheterodyne, regenerative or reflex, the addition of the Acme A-2 Audio Amplifying Transformer will make it better. They have given the pleasure of "amplification without distortion" to thousands of people. Try them and note the difference.

Each Acme—A-2 is tested and carries a guarantee tag. Use them in the set you build. Insist on them in the set you buy.

Send for our 40-page book which explains how to get the best results with your set. Also contains valuable wiring diagrams. It will help you build a set. Mail the coupon with 10 cents.

Can your radio do that for you in summer time? Do you enjoy what you hear — voices that sound clear, music pure in tone and quality?

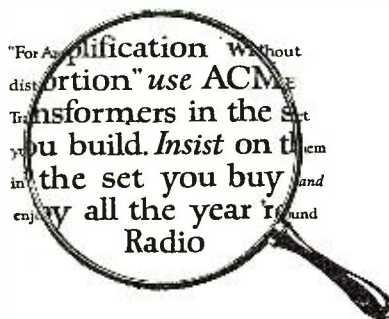

ACME APPARATUS COMPANY
Transformer and Radio Engineers and
Manufacturers
Dept. K5, Cambridge, Mass.

ACME

~for amplification

ACME APPARATUS COMPANY,
Dept. K5, Cambridge, Mass.

Gentlemen: I am inclosing 10 cents (U. S. stamps or coin) for a copy of your book, "Amplification Without Distortion."

Name
Street
City State



Add RELIABILITY To Your Radio

YOU can get the best out of your radio, whatever make or model, and prolong the life of your tubes by insuring the proper grid and filament voltage for operation through the use of the Weston Radio Table Voltmeter.

Pin jacks and a pair of cables accompany each instrument. The pin jacks serve to connect the filament circuits to the panel so that the voltmeter may be plugged in at will.

You can make the fastest change from head-set to loudspeaker with the Weston Radio Plug.

See them at your dealer's or write us for the famous booklet "Weston Radio Instruments."

WESTON ELECTRICAL Instrument Corp.

173 Weston Avenue, Newark, N. J.



TUBES REPAIRED

Burned Out Filament or Broken Bulb—Send Us the Tube.

All Work Done in Our Own Laboratory

We are not agents but own and operate a fully equipped tube factory manned by experienced tube experts. Our work is, therefore, superior and you are certain of satisfaction. We guarantee to return genuine element to you. New glass bulb put on in every instance, insuring correct vacuum and proper "hardness" for the type of tube. Tubes returned parcel post C.O.D. Send yours in today.

\$1.50

CHICAGO ELECTRIC DEVICES COMPANY
Established 1920. 76 E. 22nd St., Dept. 24, Chicago

Music Master

PROVEN RADIO PRODUCTS

MUSIC MASTER CORPORATION
10th & Cherry Sts., Philadelphia

were heard from station KDKA at East Pittsburgh, Pa., with fair audibility on detector alone.

At the present time the tube is only of scientific interest, but all that is now necessary is the usual reduction work to get it into shape for production. It is hoped to have the tube on the market in the late fall, and it is possible that it could be made to sell at a price not exceeding one-half the price of the present tubes, a feature most attractive to the amateur and experimenter.

Radical departures from the standard practice of vacuum tube manufacturing have been very few, not at all in keeping with the advances made in the development of other parts of radio equipment. This probably is due to the fact that few experimenters are equipped with materials necessary for the construction of a tube.

A Simply Constructed Wavemeter

(Continued from page 58)

wavemeter as shown in Fig. 3, it is a simple matter to determine the wave-length of any incoming signals. This is done simply by receiving signals on the three-circuit tuner, as in Fig. 4, bringing the wavemeter near it and tuning the wavemeter until

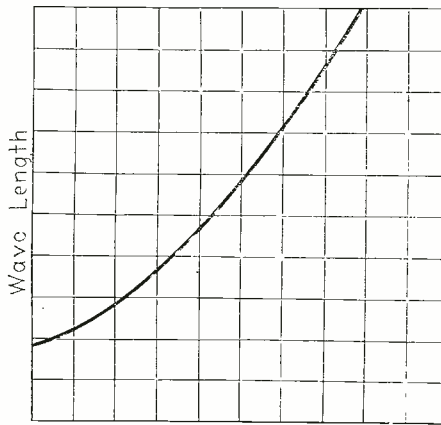

Dial Setting
Fig. 3

This is a sample of the wavemeter calibration that can easily be made by anyone.

whistling occurs. From the dial setting of the wavemeter condenser on the calibration curve, the wave-length of the station is immediately known. It will be noted that this is just the reverse of the method used in calibrating the wavemeter.

Further Notes on "B" Battery Eliminator from Standard Parts

(Continued from page 57)

It will be seen that the circuit is identical with the filter shown in Fig. 1, except for the protective resistances added in the form of lamps. It will be necessary to place a 1-mfd. condenser in the ground lead to prevent shorting the "B" supply, and any ground connection to the "A" circuit should be re-

DUPLEX MATCHED CONDENSERS

Afford Uniform Dial Settings



And Simplify Logging

Know the satisfaction and ease of tuning that come when all dials read alike. Use **DUPLEX Matched Condensers**—the supreme achievement in condenser building. Condensers are the "heart" of any set and matched condensers are absolutely necessary if your set is to be free from "heart" trouble. **DUPLEX Matched Condensers** are made in strict accordance with Bureau of Standards specifications for lowest losses and best electrical characteristics. They are tested, matched, packed and sealed in the laboratory, to remain unopened until used. **DUPLEX Matched condensers** are used in the famous Thermodyne, where matching is essential.

Folders explaining how and why matched condensers are essential sent on request.

DUPLEX CONDENSER & RADIO CORP.
52 Flatbush Ave. Ex., Bklyn., N. Y.

THE LARGEST RADIO STORES IN AMERICA

THE HOUSE OF QUALITY AND SERVICE

Hook-ups!

All the latest and best kits in our new

RADIO CATALOG

FREE

JUST OUT! Our new 1925, ninety-six page Catalog including all the best and latest Kits, Parts and Accessories. Also our new 32 page bargain section — Write for your **FREE** copy today!

SAVE MONEY! We buy up manufacturers' jobber and dealer surplus and bankrupt stocks — but only brand new fully guaranteed, nationally advertised apparatus. Our enormous buying power permits us to pay spot cash and get rock-bottom prices, even way below manufacturer's costs.

CHICAGO SALVAGE STOCK STORES

509 So. State St., CHICAGO, ILL., Dept. R.N.6

Wire-Nuts for joining

radio antenna and lead-in wires in one minute without solder, tape or tools. Many other uses. A million perfect joints have already been made with these new Wire-Nuts. Listed by Underwriters' Laboratories. Booklet free. Ask your dealer for Wire-Nuts.

We will send 3 Wire-Nuts post paid on receipt of 25c. **N. TORK COMPANY, 8 W. 40th St., New York**

The EAGLE Neutrodyne RECEIVER

is "King of The Air"

Write for literature.

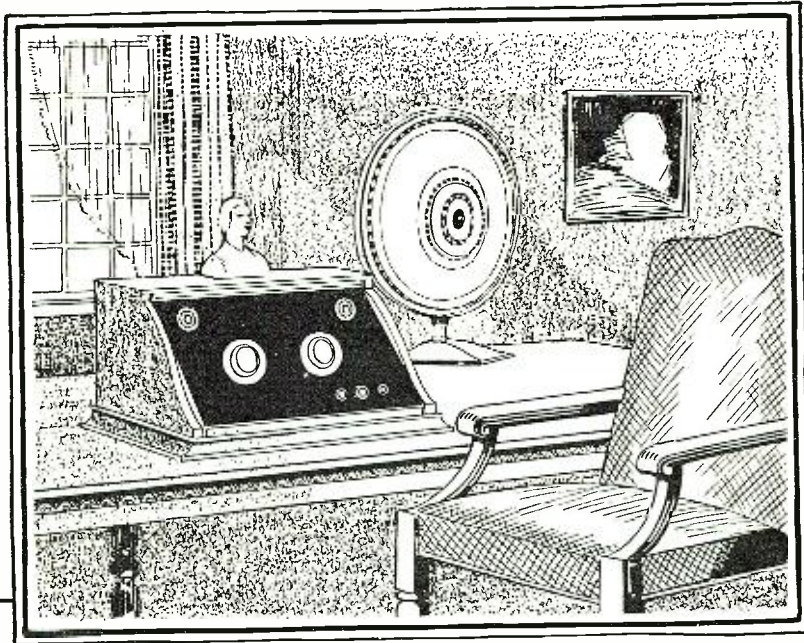

FORMICA

is the mark of quality in radio

FORMICA panels, tubing and Base panels are the marks of quality in a radio set. You can be sure that the set which has them has been built for lifetime service — and that enduring good performance has not been sacrificed to the saving of a few cents here and there.

It is more necessary than ever this year to judge a radio set by the material it contains. Price competition last year brought in the type of apparatus that would perform beautifully for a week or two and then quit. And price competition is still with us.

Formica is used by nearly all the great makers of high quality apparatus. They swear by it as they always have. Be sure you have it in the set you buy.

Dealers: Formica is the standard panel in the eyes of the amateur. He wants it, and dealers who give it to him make the most from their panel business.

THE FORMICA INSULATION COMPANY

4618 Spring Grove Ave., Cincinnati, Ohio

Sales Offices

50 Church Street.....	New York, N. Y.	1026 Second Avenue.....	Minneapolis, Minn.
9 South Clinton St.....	Chicago, Ill.	725 Bulletin Bldg.....	Philadelphia, Pa.
516 Caxton Bldg.....	Cleveland, Ohio	708 Title Building.....	Baltimore, Md.
1142 Granite Bldg.....	Rochester, N. Y.	585 Mission Street.....	San Francisco, Cal.
422 First Avenue.....	Pittsburg, Pa.	419 Ohio Building.....	Toledo, Ohio
6 Beacon Street.....	Boston, Mass.	309 Plymouth Bldg.....	New Haven, Conn.
55 Calle Obispo.....	Habana, Cuba	Whitney Central Bldg.....	New Orleans, La.

Write for Booklet "What Formica Is"

- 1 Formica is used by 125 leading makers — and has for years been used by more makers than all other materials.
- 2 Formica will last forever.
- 3 Formica, in appearance, is the finest of all panel materials and always remains so.
- 4 Formica's electrical qualities of every kind far exceed any possible requirement.
- 5 Formica has high mechanical strength and will not break in use.
- 6 Formica will not sag from heat or cold flow under pressure. It retains its dimensions. Everything you fasten to it stays tight and precisely where you put it.
- 7 Formica panels are sold in neat craft paper envelopes which assure you that you are getting the genuine.
- 8 Formica is one of the most widely approved materials in radio.



FORMICA

Made from Anhydrous Bakelite Resins
SHEETS TUBES RODS

Hear the Formica Orchestra over WLW every Tuesday evening from 9 to 10 Central Standard Time.

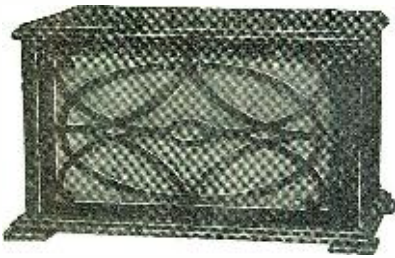

Model C Cabinet, \$30.00

Getting Concerts Whole

It soon dawns on the owner of a Bristol Speaker that he is listening in on entire concerts.

That roving disposition to tune in every station on the map is due, much more than is generally supposed, to a yearning for really sweet music.

One reason radio music does not always sound sweet is that certain of the tones are out of tune.

Coming through a Bristol Speaker, all the tones are evenly in tune. The result is an arresting sweetness that "invites" you to stay through a concert to the end.

BRISTOL AUDIOPHONE LOUD SPEAKER

For \$25 and \$30 you can get a Bristol Speaker; and there are others as low as \$12.50. Ask your dealer to send one out. Write us for Folder No. 3022-S, telling why the Bristol is such a delight to the ear.

THE BRISTOL COMPANY
Waterbury, Conn.



FORMICA RADIO PANELS TUBES AND RODS

WRITE TODAY for your copy of our new catalog listing and pricing 3384 different sizes and kinds of Formica Radio Panels, 126 different sizes of Formica Tubes, and 21 different sizes of Formica Rods.

DRILLING—ENGRAVING
Lowest prices consistent with good work
STARRETT MFG. CO.
520 S. Green St. Chicago, Ill.

Price \$1.50
THE IDEAL RADIO RHEOSTAT
Mfgd. by Marshall Electric Co.,
3235 Locust Boul., St. Louis, Mo.

moved for the same reason. Any non-conductively coupled sets may be operated without change.

Additional voltage taps may be made on any of the eliminators by connecting an additional resistance and condenser as shown in dotted lines in Fig. 2. Such a tap is useful on some radio frequency circuits to supply approximately 67 volts. An overall control of output voltage may be secured on the D.C. eliminator by placing a variable resistance (1,000 to 10,000 ohms) at "X," Fig. 2.

The Juice Hangs High

(Continued from page 41)

with me, but I smiles and covers things up by saying no more. But I takes a good squint at this egg. Faces is my middle name, and if this bird ain't got the nearest approach to the well-known complete criminal type, I'll listen to static for six hours. So I holds my peace till we're home.

"And you calls that an enjoyable evening," I grunts. "Say, in the time we wasted I couldda wired up the niftiest—"

"Oh, sleep it off," commands Doris.

Well, the next day Doris keeps me at home until after noon, when I slips outa the window and takes a sneak cross-country hop over to the Master's.

This last ain't his real name, which is Gerard Lawson. We calls him the Master, outa compliment to his butlers, of which he has a flotilla of no mean armament. Jerry's a nice, young, dark-haired and humorless gentleman with a passion for science and a particular craving for radio. Yes—he's a nut, and with millions to back it up, too.

"Oh, hello, Joe," he says, as I skips up the stairs into his laboratory. "I missed you last night."

"And I missed you, too," I admits. "How'd you manage to get outa that construction party?"

"Construction party?"

"Bridge," I supplies. "How'd you do it?"

"Why, I simply sent regrets," says Jerry. "Why didn't you?"

Since he ain't married, I can't explain logically. So I lets it lay. The Master is busy wiring up some new spasm. I asks him what it is, being so privileged.

"Oh, I've just finished a good morning's fishing," he explains. "Merely disconnecting the leads."

"Whadda ya mean—fishing?" I asks. "Have you been out in a boat all morning without trying to rescue me?"

The Master stares at me. "Out in a boat?" he repeats.

"Sure," I says. "How could you fish otherwise? By radio?"

"Precisely," says Jerry, calm-like.

"Aw, gwan," I remonstrates. "It's my turn to tell one."

"Why, I thought I'd told you before, Joe. Haven't you seen my new radio fishing device?"

I admits the bad luck. Then Jerry gets into one of his explaining moods.

"I am very fond of fishing, but cannot tolerate the blazing heat of the sun. So I devised this apparatus whereby I am able to fish without moving from this room."

"Old man efficiency," I grins. "Go on."

"I have a float anchored about half a mile out," says The Master. "On this float is a device wherefrom are trawled six lines, each with hook and artificial bait. The moment a fish takes a nibble, the slight tug produced is registered on one of these six small dials. On each dial is a black line.

Battery Prices SMASHED!
To Consumers Only
Here is a real battery quality, guaranteed to you at prices that will astound the entire battery-buying public. Order Direct From Factory. Put the Dealer's Profit in your own pocket. You actually save much more than half, and so that you can be convinced of true quality and performance, we give a *Written 2-Year Guarantee*. Here is your protection! No need to take a chance. Our battery is right—and the price is lowest ever made. Convince yourself. Read the prices!

Auto Batteries	Radio Batteries
6Volt, 11 Plate, \$9.50	6Volt, 100 Amp. \$9.50
6Volt, 13 Plate, 11.50	6Volt, 120 Amp. 11.50
12Volt, 7 Plate, 13.00	6Volt, 140 Amp. 13.00

Buy Direct—Send No Money
We ask no deposit. Simply send name and address and style wanted. Battery will be shipped same day we receive your order Express C.O.D. subject to your examination on arrival. Our guarantee accompanies each battery. We allow 5% discount for cash in full with order. You can't lose! Send your order today—NOW!

ARROW BATTERY CO.
Dept. 6 1215 S. Wabash Ave., Chicago

Havana, Cuba, on Crystal Set

"We had P.W.X. Cuba, on our crystal set and tuned in on tube set for verification. We could not believe it."
"Also received stations in eight states using A-1 crystals. These included WBZ, WGY, WTAM, WOR, WHB, WNJ, WAS, WEBB, WLN, WLS, KDKA, WCBD, KPFT." —E. H. W., Louisville, Ky.

A-1 THE WONDER CRYSTAL

For Reflex or Crystal Set
Sent Postpaid by Insured Mail 50c each
Dealers Write for Discounts.
California Radio Minerals
Harry Grant, Jr.
904 Oak Grove Ave.
Burlingame, California

PERSONAL STATIONERY

200 SHEETS and 100 ENVELOPES \$1.00

Printed with your Name and Address
Clear, white bond paper, with envelopes to match. Your name and address printed in beautiful rich blue ink, on both paper and envelopes, and sent to you postpaid for only \$1.00. (West of Mississippi river and outside of U. S. \$1.10.) If inconvenient to send the money, we will ship C. O. D. Money returned if you are not more than satisfied. Order today. Write name and address plainly.

AGENTS MAKE BIG MONEY

taking orders for us. Write us today for our agent's proposition.

ELITE STATIONERY COMPANY
7056 Main Street Smethport, Pa.

KEYSTONE ARRESTERS

FOR BEST LIGHTNING PROTECTION AND MAXIMUM RECEPTION

GOLD SEAL HOMCHARGER

The World's Most Popular Battery Charger
Write for Booklet
THE AUTOMATIC ELECTRICAL DEVICES CO.
121 West Third Street Cincinnati, Ohio

INSIST UPON

AIR CONDENSERS

VERNIER & VARIABLE

Now Hear Radio Music Better Than Ever Before

By the end of this year, we expect to see the beautiful new Crosley Musicone replace at least half a million of the best of present-day radio reproducing devices.

For the Crosley Musicone, designed and built on entirely new principles, covered by *basic patents* issued and pending, reproduces music and the speaking voice true to life—

Without distortion, extraneous overtones, resonance vibrations or other horn noises;
Over the *entire* musical scale, from lowest to highest notes, on *any* instrument;
Without overloading; and without chattering, because its diaphragm is a floating cone;
Without adjustments or additional batteries;
Without directional properties or a horn;
And at a price that is revolutionary.

Sound from it fills the entire room, the notes clear and round and mellow. No need to cluster round. Every note comes in at its true musical value—in solo, duet, chorus, orchestra and drums.

Your own radio set—no matter what circuit nor how many tubes—needs the Crosley Musicone; and until it has this instrument, it can never give you the best that its maker built into it.

Ten thousand radio dealers are now displaying and demonstrating the beautiful Crosley Musicone.

By all means hear it, and know for the first time what real radio music is. Then equip your set with this beautiful, compact reproducer and no other. Write for complete description.

The Crosley Radio Corporation, Cincinnati
Powel Crosley, Jr., President
722 Sassafras St.

Guarantee

Dealers are authorized to sell the Crosley Musicone on five days' trial in your home. Satisfaction guaranteed or money refunded upon return.

Crosley manufactures receiving sets which are licensed under Armstrong U. S. Patent No. 1,113,149, and priced from \$14.50 to \$65, without accessories.

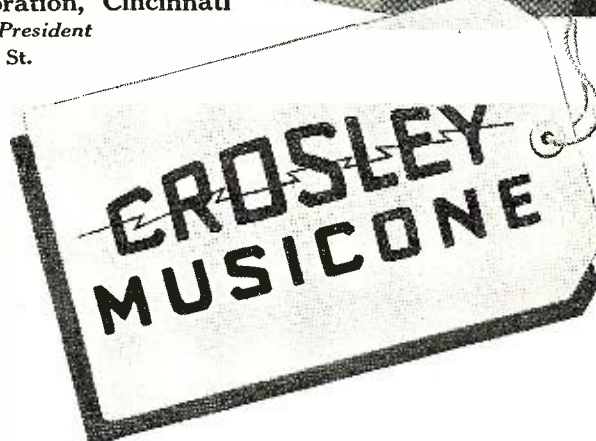
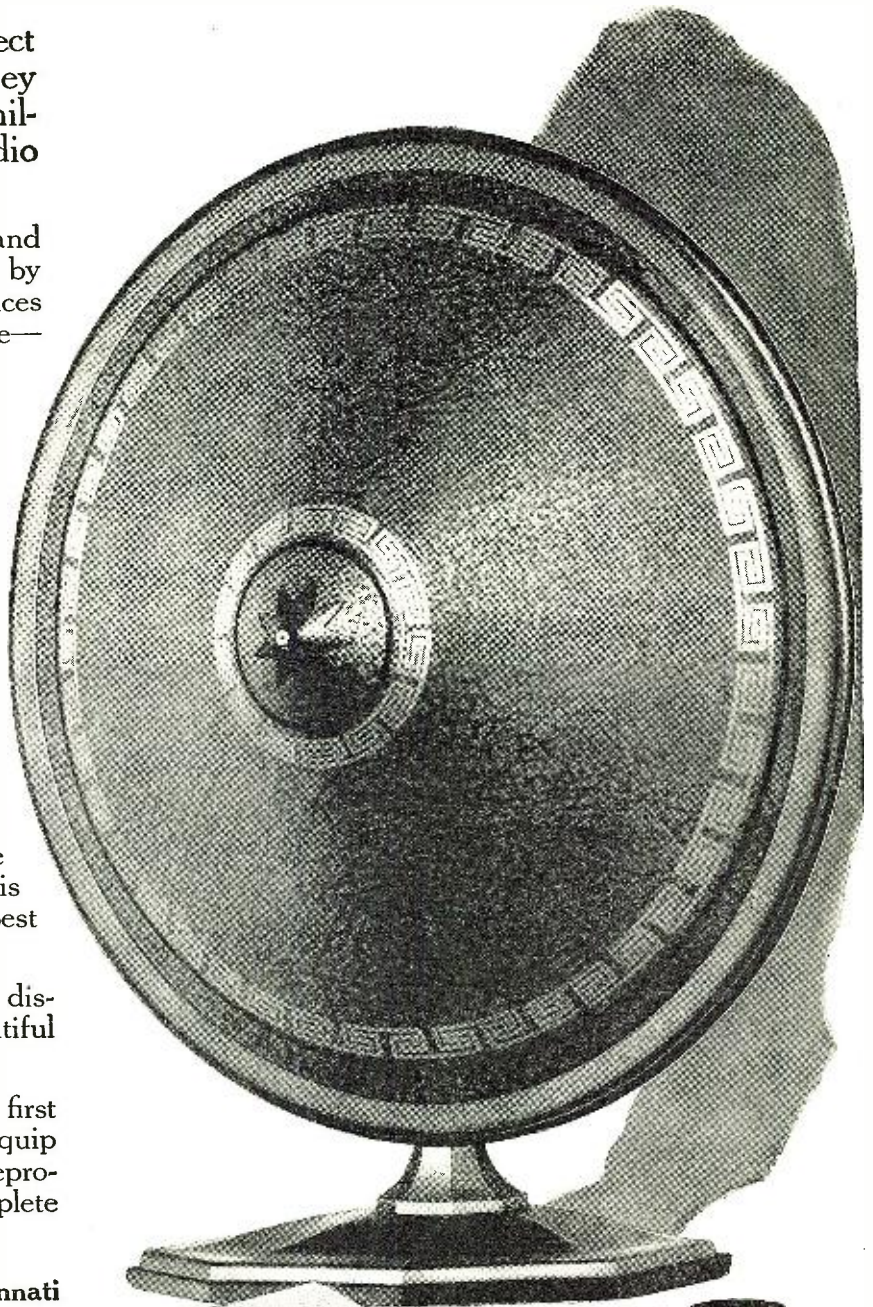

17⁵⁰

Add 10% West of Rocky Mountains.

The Crosley Musicone is artistically beautiful—an ornament in any home.

Crosley owns and operates station WLW, Cincinnati, the first remotely controlled super-power broadcasting station.

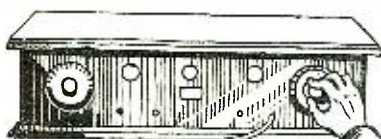

Tune in indoors!

Take your loud speaker outside when it's too warm to dance—or even to sit and visit—in the house.



You lose no volume through a PREMIER Cord. It's tightly braided for maximum wear, will not break, kink or fade and adds much to your radio enjoyment. Price \$1.75, complete with Universal plug.

At your dealer's
—or write us.

CRESCENT BRAID CO., Inc.
Makers of Extension Cords and Battery Cables for Radios

Providence, R. I.

Dance on Your Porch



NEW RADIO TUBES

Meter Tested **\$2.00** Matched Guaranteed

ALL TYPES

Specify type when ordering. We ship Parcel Post C. O. D.

OHIO RADIO SALES
723-H Rose Bldg. CLEVELAND, OHIO

Day-Fan RADIO

A Year Ahead

The set with the air telephone directory
The Dayton Fan & Motor Company
DAYTON, OHIO

FREE Big catalog containing hundreds of bargains in standard radio sets, kits and parts. Write today.
WESTERN RADIO MFG. CO.
138 W. Lake St. Dept. 3-7 Chicago

which I have termed the bite point. When the indicator needle passes the bite point, I press the corresponding push-button, and the line is quickly coiled in. The minute the fish is drawn over the top, it is dropped into a net. If it escapes, this blue light flashes; if it is captured, this red light glows. After falling into the net, a separate transmitter automatically transmits to this large dial the exact weight of the specimen. When I find myself to have reached the limit set by the law, I throw in this switch, which coils in all the lines and starts the motor which pulls in the cable fastened to the float. Thus, I can seat myself comfortably in this room, and by merely watching the dials and the fluctuations thereon I can tell when I have a bite. All I have to do is watch close and press quick, although I could dispense with the buttons entirely, should I so desire. However, their presence makes it more sportsmanlike. I shall demonstrate it to you."

He sets the outfit in action, and we waits for a nibble. Pretty soon the third dial begins to move. Suddenly it passes the bite point. The Master pushes the button; a red light flashes, and the large dial records the weight—three pounds, eight ounces.

"So you see I can enjoy all the thrills of fishing without leaving my work," says Jerry. "Rather novel, isn't it?"

"All I can say is, this beats the gag about Jonah," I grins.

Soon Jerry's busy at something else. "And what's this?" I inquires, pointing to a dignified-looking panel and an immense circle of porcelain. "I suppose this is used to find out Why Girls Leave Home, in five parts?"

The Master muses a moment. "That's a rather odd thing, Joe," he says, abstract. "I think your knowledge of the theatre will serve me no small amount. Will you help me?"

"How'd you guess?" I replies, eager. "Spread the info."

"Joe, are you familiar with street carnivals?"

"Am I?" I asks. "Boy, I got these leather bellows selling soap on many a midway."

The Master's pleased. "Fine," he says. "And how are you on gambling devices?"

"Outside of draw poker, not so good," I states. "But do you mean crooked ones—three-card-Monte men, or pea-under-the-shell guys?"

"Roughly, yes," says Jerry. "There's a carnival exhibiting up the island a ways that's due here tomorrow. They have a gambling device that absolutely defies any form of detection. It is apparently, yes, obviously square and above-board, yet it cannot be beaten successfully. I have a vague idea as to how it may be controlled, and shall need your help all day tomorrow."

"O. K. with me," I says. "What's the thing like?"

"It consists of a base of solid porcelain, eight inches thick by six wide and two feet long. This base supports in a vertical position a circle, or rim of porcelain about two feet in diameter. You will notice a similar one here on the bench. I have made mine nearly the same size as the original, it being three inches thick by four wide. Inside this large rim rotates a wheel, also of porcelain, the rim of the wheel coming within an eighth of an inch from the large outside rim. The game is a variation of roulette; a pointer on the wheel stops or does not stop on one of the sixty spaces on the outer rim. The only possible method of control would be the use of magnets, but this is clearly not the system, since the porcelain base rests on plate-glass posts, and I have closely examined these, and there are no wires of any kind. In fact, the device works while I am holding it in my arms."

"What's your idea of it?" I inquires. "Could it be radio?"



JEWELL Lightning-Arrester

(Approved by Underwriters)

Carried in Stock by
Leading Radio Dealers
in U. S. and Canada

Jewell Electrical Instrument Co.
1650 Walnut St., Chicago



Easy to Install Easy to Tune PROUDFOOT LOW LOSS CONDENSER

Just a half-inch hole drilled in your panel is all that is necessary to install the Proudfoot. And after it is mounted it can be tilted to the most efficient working angle merely by loosening the locknut.

The Proudfoot tunes just as easily as it mounts. Rough adjustment is made by turning the whole knob. Verrier adjustment is made by turning the pointer section only. Second scale gives definite verrier reading. Made in the following sizes and favorably priced.

Number of Plates	M. F. C.	With Verrier Dial and Knob	Without Verrier Dial and Knob
12	.00025	\$3.75	\$3.25
17	.00035	4.40	3.90
25	.0005	4.50	4.00
43	.001	5.75	5.25

Get one at your dealer's today. If he cannot supply you write us. Circulars on request.

CRUVER MANUFACTURING CO.
2456 W. Jackson Blvd. Chicago, Ill.

Build Your Own RADIO RECEIVER and Save Money. Revolutionary Method!

SEND FOR BIG KIT CATALOG and learn how. (See big advt. on page 12.) Radio Specialty Co., Div. 679G, 245 Greenwich St., N. Y.

KNOW INSTANTLY THE ACTUAL TIME ALL AROUND THE GLOBE at any hour, day or night, with "FIND-ME-QUICK" WORLD'S TIME INDICATOR
Durable, useful gift for old and young. Indispensable for every DX Radio Fan. Valuable advertising novelty.
Practical Vest-Pocket Size, 25c Postpaid
\$2 Per Doz., C.O.D.; Quantities Liberal Discount.
RADIO CHART BUREAU Fresno, California

HUDSON-ROSS

Wholesale radio only.
One of the first and still in the lead.
Write for discounts.

123 W. Madison St. Chicago

This Amazing New-Type Coil is Revolutionizing Radio Set Building

MODERN electrical science has discovered a new principle in radio frequency amplification—a new improved transformer that gives the most amazing results.

It is known as the Erla Circloid. Simply clip the coupon below—and let us send you the complete technical story.

4 vital improvements

The story of Circloid advantages is a fascinating study—even for those who are not interested in the technical side of radio.

As practically everybody knows, in the ordinary radio set, not only the antenna but the radio frequency coils themselves act as pick-up devices of broadcasting signal. This is one of the chief causes of what most radio fans call "broad tuning."

With Erla Circloids, independent pick-up of signals by the coils is completely done away with. Selectivity of the receiver is always at maximum. Sharp tuning and less interference are the direct result.

Static disturbance has been reduced to the very minimum. For everybody knows that static has no particular wave-length. It invades them all. And because the Circloids have no pick-up qualities, only such static as happens to be present on the exact wave-length to which the receiver is tuned can

Three Great Advantages

1. The absence of an external field eliminates the effect of the coil upon nearby coils or adjacent wiring circuits.
2. The Circloid has no pick-up quality and is rendered immune from outside electrical influence.
3. Its efficiency is higher than any other type of coil and losses are unbelievably low.

The New Erla Balloon Circloid Radio Frequency Transformer and Coupler

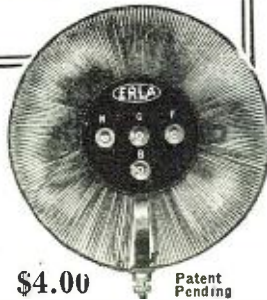

\$4.00

Patent Pending

come through. Thus here at last is a radio set that offers new delights in summer-time radio. No other receiver can provide such perfect freedom from annoying interference.

Another Circloid improvement is greater stability—smoothness of operation and ease of control.

The tendency of conventional receivers to squeal and howl uncontrollably is due to excessive feed-back between coils and wiring circuits.

With Circloid feed-back of energy is eliminated between

coils and confined solely to the wiring circuits where it is subject to complete control. Thus perfect stability is obtained. Oscillation that is sudden and violent in the average receiver, making it necessary to start tuning all over again, is now controllable. Just the slight turn of one control and it is completely controlled.

But the most important of all Circloid improvements is its effect upon tone quality. Any radio engineer will tell you that excessive "feed-back" is the greatest cause of distortion or blurring.

And Circloids, because they have no external field, eliminate stray feed-back effects and do away completely with this principal source of tonal distortion.

Only with the Circloid principle can supreme musical clarity and fidelity of reproduction be obtained. No other radio set can offer you these exclusive advantages. No other set can offer these supreme achievements.

4 ways to buy the Circloid

Erla Circloid Transformers are offered for sale, \$4.00 each—in kits of three, \$12.00—in kits of three with Erla Condensers, \$21.50—and in Factory-Bilt Kits, \$49.50. They may be obtained direct from your nearest dealer. Or write direct for detailed information.

ERLA * CIRCLOID *Radio Frequency Transformer*

*Trademark Registered

Electrical Research Laboratories, Inc.
2502 Cottage Grove Ave.,
Chicago, Ill.

Gentlemen: Please send me detailed information about the new Erla Balloon Circloid Transformer.

Name

Address

Introducing "HAMMARLUND, JR"

The Precision Midget

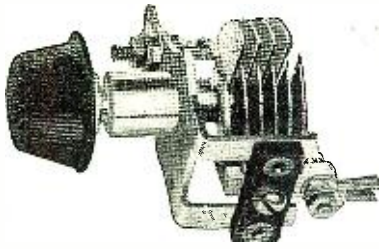

THIS new member of the Hammarlund Precision Condenser family was born early in April.

Midget, though he is, you will recognize all the famous family characteristics: Sturdy build, compact design, smooth operation and dependability.

He has the same soldered brass plates, the same aluminum end-plate, the same minimum dielectric (only one small strip of hard rubber), the same clock-spring pigtail, the same smooth-running bearings and a new feature—*one-hole mounting*.

You will find him helpful in any good radio set and a handy assistant in the experimental laboratory.

Use him for capacity antenna coupling, tuned tickler regeneration, capacity regeneration, neutralizing tube capacities, audio tone control, etc.

Maximum Capacity, .000032
Minimum Capacity, .000004

\$1.80 at all good radio dealers.
Price includes Bakelite knob, but as rotor shaft is standard, any other knob or dial may be used.

Write for folder describing details and containing diagrams of various uses.

Hammarlund Manufacturing Co.
424-438 W. 33rd St., New York
Export Offices: 375 Broadway, New York

For Better Radio
Hammarlund
PRECISION
CONDENSER

Copyright March 17, 1925.

At your dealer **50c**

DON'T
let 'em meddle with
your set—
LOCK IT
with a
WALBERT
LOCK SWITCH
WALBERT
made it first

WALBERT MFG. CO., CHICAGO

"That's my idea at present, substantiated by the fact that the owner refuses to let anyone enter the rear half of his tent. Radio control would be possible, but how to prove it without attracting the attention of the operator? It took all my strength to lift the apparatus; it is entirely likely there may be concealed mechanical or electrical controls within the porcelain. That remains to be seen."

"But what's the excitement about?" I asks. "Surely, this guy ain't operating an out-and-out gambling tent and getting away with it?"

Jerry smiles. "Of course not," he says. "The affair in the beginning was a candy raffle, and this disguise is still used during the day. You see, a party of rich people saw the wheel, and were impressed with it as a new means of gambling. They offered—in private—to play for money with the concessionaire. The bets waged high, and the wheel lost little. The players were too good sports to tell the police. They asked me to investigate it; if it's fair, they have no complaint, but if they've been cheated—well, that's another thing."

"I see," I says. "During the day he uses it for a candy raffle, you say?"

"Yes. He charges ten cents a spin, giving away a cheap box of candy with each twist of the wheel in order to evade the law. Each of the numbers on the wheel is represented by an article of some sort. The usual run of such things—dolls, canes, watches, and so on. Thirty of the sixty spaces call for prizes; the other thirty merely net the gambler the cheap candy. This part is as fair as anything of its kind. The candy raffle being, of course, merely a blind for the gambling."

I'm curious. "How long have people been gambling with this wheel?" I inquires.

"About two weeks," answers The Master. "A party of young folks first saw it, I believe. Why?"

"Oh, nothing, as yet," I says. "Just wanted to know. Might come in handy, you know."

"Then you'll meet me tomorrow, about one-thirty," says Jerry. "We'll have to do a little experimenting."

So the next day I breezes over to The Master's and helps him into a trick suit wherein is concealed a highly compact receiving outfit. Jerry puts on a single receiver, feigning deafness, and we stands in front of the wheel.

After about ten minutes Jerry draws me aside. "I can detect nothing," says Young Sleuth. "I've an idea they're not using the radio on the candy end of it. Joe, you get chummy with the concessionaire and try to place a few cash bets."

This takes an hour or so, but finally the operator agrees to let me play a couple twentys on number thirteen. He covers up the money end and acts as if I'd just paid my dime.

"The gentleman bets on thirteen," yells the concessionaire. "Here you are, ladies and gents, a real sport, takes a chance on thirteen." Zip! And the wheels that never fails stops on twenty-seven. "Try 'em right over again, folks! Only a dime, two nickels, the tenth part of a dollar!"

I notices that he's yelling a lot louder than he did before. I goes back and consults The Master. He's excited.

"It's working," he says. "All I need to complete my records is two more tests. Joe, bet on twelve, and then fourteen."

I does, and loses. Then I goes back to The Master.

"Well?" I asks.

"I've got them!" says Jerry, quick and sure. "They're using radio to control their magnets, and I think I've got their wavelengths. I'll try tonight and see what I can do to influence the wheel. Meanwhile, you

A Pleasant Surprise Awaits the User of the A.C.H. Sharp Tuner Dials WORM DRIVE

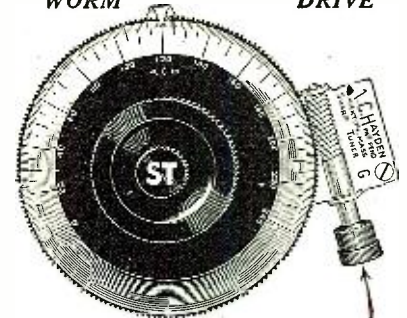

Why the A.C.H. is different

3 in. DIAL → ACH → (156-TO-1)
4 in. DIAL → ACH → (215-TO-1)

Money Back Guarantee

Price 3-inch size...\$2.50 Price 4-inch size...\$5.00
Regular fitting 5/16 shaft ¼ and 3/16, 5c each extra

- EXTRA ADVANTAGE OF THE A.C.H.**
1. Can be attached or removed from any instrument.
 2. Rough tuning same as any dial.
 3. Movement so fine that the eye cannot detect but the ear can.
 4. Automatically locks instrument so no jar can disturb it.
 5. Dial grounded reducing the body capacity to a minimum.
 6. Special dial 2 graduations where ordinarily one.

Mail Orders Sent Prepaid in U. S. A.
A. C. HAYDEN RADIO & RESEARCH CO.
25 E. Battle St., BROCKTON, MASS., U. S. A.

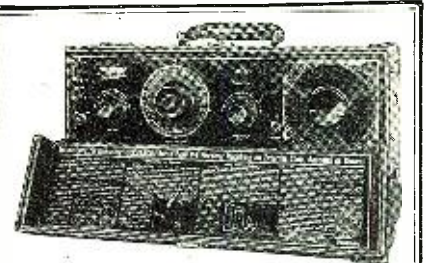

The Famous Truly Portable TELMACO P-1 Receiver

Four Tubes Do the Work of Seven

The peer of portables in size, weight, ease of tuning, selectivity, distance, volume, workmanship and price. Aerial, loud speaker and batteries self contained. Complete with tubes and batteries, **\$125.00**
Receiver only \$143.50.

P-1 Kit Saves You Money!

Our offer of the Telmaco P-1 Receiver in kit form has met with enthusiastic reception. This contains all parts, as built by us, including case, drilled and engraved panel, and illustrated instructions. **\$80.00**
Complete kit
Ask your dealer or write us. Descriptive folder free.

Radio Division:

Telephone Maintenance Co.
20 So. Wells St. Dept. B Chicago, Ill.



Quality Radio Exclusively Established 1918

RADIO TUBE EXCHANGE

We Repair All Stand. Makes of Tubes \$1.50
U. V. 202 Repaired, \$3.00

All Tubes Guaranteed to Do the Work
Radio Tube Exchange, 200 Broadway, N. Y.
All Mail Orders Given Prompt Attention
Orders Sent Parcel Post C. O. D.



Authorized Cockaday Coil \$5.50
Precision Autodyne Coupler \$3.50

PRECISION COIL CO., Inc.
209 CENTRE ST., NEW YORK CITY
Specialists in the manufacture of all types of radio coils

Insure your copy reaching you each month.
Subscribe to RADIO NEWS \$2.50 a year.
Experimenter Publishing Co., 53 Park Pl., N. Y. C.

Biggest dollar's worth in RADIO

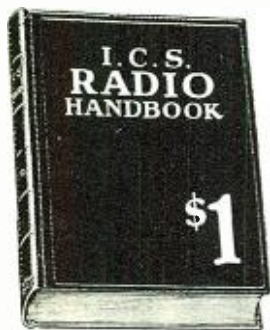

Compiled by
HARRY F. DART, E.E.
Formerly with the
Western Electric
Co., and U. S.
Army Instructor
of Radio.
Technically edited
by **F. H. DOANE**

514 PAGES—ONLY \$1

ONE of the most complete books of its kind ever published. Written, compiled and edited by practical radio experts of national reputation. Packed with concise, sound information useful to every radio fan—from beginner to veteran hard-boiled owl. Contents—

Electrical terms and circuits, antennas, batteries, generators and motors, electron (vacuum) tubes, most receiving hook-ups, radio and audio frequency amplification, broadcast and commercial transmitters and receivers, wave meters, super-regeneration, codes, license rules. Many other features.

Just mail the coupon with a dollar bill and your name and address, and this 514-page I. C. S. Radio Handbook will be sent to you by return mail. Note the other good books listed below at low prices.

INTERNATIONAL CORRESPONDENCE SCHOOLS

Box 8284-E, Scranton, Penna.

I enclose \$..... for which send me, post-paid, the Handbooks marked X, at \$1 each. It is understood that if I am not entirely satisfied I may return them within five days and you will refund my money.

- RADIO HANDBOOK, 514 PAGES, \$1
- Automobile Handbook, 354 pages - - - \$1
- Electrical Handbook, 414 pages - - - \$1
- Chemistry Handbook, 318 pages - - - \$1
- Pharmacy Handbook, 321 pages - - - \$1
- Traffic Handbook, 386 pages - - - \$1
- Building Trades Handbook, 409 pages - - - \$1
- Machine Shop Handbook, 335 pages - - - \$1
- Salesman's Handbook, 352 pages - - - \$1
- Advertising Handbook, 445 pages - - - \$1
- Bookkeeper's Handbook, 302 pages - - - \$1
- Civil Engineer's Handbook, 411 pages - - - \$1
- Steam Engineer's Handbook, 298 pages - - - \$1

Name.....

Address.....

Enclose \$1.50 for each book if you want the Leatheroid binding. All of the above books can be had in this binding except the Traffic Handbook and the Building Trades Handbook.

Radiofeet Cushion your Set!

Stop tube vibration! Prevent set from rattling furniture! Used under set or tube shelf. Made of pure wool felt.

Set of 4 Radiofeet, including attaching screws or washers sent postpaid anywhere in the United States or Canada for \$1.00. Do not send stamps. Specify dark red (mahogany) or brown (oak) color.

NEODYNE ASSOCIATES

(Incl. N.Y. Reg. Paid)
3121 Benenson Building
165 BROADWAY, NEW YORK

SUPER-HETERODYNE
Ultradyn—Haynes Griffin—Remler
Dealers: Send for Discounts
HUDSON-ROSS
123 W. Madison St. Chicago

see if you can buy out that peg-and-ring concession right across the midway. In fact, you must get that one, and no other. And you might get acquainted with the people around here, so as to avoid suspicion."

Which is a pretty sudden order of its kind, but I manages to make the grade. I happily discovers the owner of the carnival is an old buddy of mine, and he sees to it that the desired location is mine, not knowing, of course, why I wants it. I tells him I'm dying to get back in the old game. So I takes charge of the swindle, and sorta gets to like it, for old time's sake. Also, I'm doing a fair business, so I stays on for the evening. Disguised in a plug hat and a flourishing mustache, nobody'll know me, so Doris won't get curious. About seven The Master comes in the back way, and I lets an assistant handle the concession and helps Jerry set up the duplicate ring and controls.

After it's all set I goes across the street and watches the wheel. Somebody bets on thirteen, which calls for a kewpie doll. I signals to Jerry, and the wheel stops on thirteen.

The concessionaire ain't the least disturbed. "Thirteen wins," he yells. "Pay the lucky gentleman, and sell him another chance!"

This sets a deluge for thirteen, so I waits till another innocent tries twenty-three. Wham! The gentleman wins!

I goes back and tells Jerry he's got it figured O. K. Then we waits until the carnival closes at midnight.

It's after hours when the big money's lost. Tonight several of the heaviest losers are coming, at The Master's request, to try and recoup their fortunes. When they arrives, the operator closes the tent flap. Being a fellow concessionaire, I'm admitted to watch, also to bet a little, for harmony's sake, along with one or two other carnival men.

The bets come and go slow now, so I goes back to Jerry and tells him to watch my hand, since I'm forced to use the one-arm semaphore to let him know the number called. We're all set, and a bet's made on eighteen.

I signals the number to Jerry. The wheel is spun, and stops—on six.

"Try 'em right over, gentlemen," says the operator, collecting his cash.

I goes back to Jerry. "Say, didn't you get me?" I asks.

"Certainly. You said eighteen."

"It stopped on six."

Jerry's puzzled and excited. "I can't understand it," he says. "Joe, make one more attempt to see in his rear tent."

I goes around to the back and finds a tall packing box. I gets up on this and peeks through a slit. The room's practically vacant. Just as I'm about to get down something tells me to look behind me. I does, and finds myself face to face with the wickest-looking gat I ever lamped.

"Reach for the sky, bo," says the proprietor of the weapon. Do I reach for it? Man, I gets it! I starts to get down.

"Stay up there, you," says the bandit, going through my pockets in a manner so thorough it'd make Doris ashamed. I ain't got much on me, my coat being in Jerry's tent. This bozo gets a few bucks and backs off, telling me to keep my mitts elevated or he'll make me an understudy for a Swiss cheese. So I holds my hands aloft. As soon as he's gone I brings my trembling digits earthward.

In so doing my palms comes across one of the guy ropes. I grasps this to steady myself, when I feels something odd about the rope. I lights a match and looks. Around the rope is wound number eighteen bell wire! All of a sudden it comes to me, clear. I takes out my knife and cuts the wire.

I rushes back to Jerry. "Keep your eyes ready," I says. "When I signals, give her the gas."



Get this handy radio guide to the construction of standard practical receivers

The radio constructor who wants to be safe and sure in the building of his radio receiver, whether it be a crystal set or some super circuit, should have this E. I. Company book at his side. This book contains a varied selection of the most practicable radio hookups in use today. Each hook-up is described in detail starting from the general characteristics of the set and then giving wiring diagram and all further information that is necessary to the final completion of the receiving set.

This book, like all E. I. Company books, is thoroughly practical and modern in every respect. It is written in plain language so that every one can understand it and all wiring diagrams are made as simple as possible.



SOLD AT ALL NEWSSTANDS AND RADIO STORES

Book No. 2 How To Make Practical Radio Receiving Sets, size 5 1/2 x 7 3/4 inches, 64 pages. Profusely illustrated, bound in stiff cardboard two-color printed cover.

You can obtain one of these books at your local Radio Dealer or by writing direct and enclosing 25c to

E.I. Company

Sole Distributors

CONSRAD COMPANY, Inc.
233 Fulton St., New York, N.Y.

ATWATER KENT RADIO

READY 22 YEARS WHEN RADIO CAME

THERE is one radio set that rode into the industry on half a million automobiles. That set is the Atwater Kent.

A quarter of a century ago we built our first Ignition System for automobiles and motor boats. That business grew and grew. Its growth expressed the confidence of leading motor manufacturers and of owners that we were truly trying to produce "the spark that couldn't fail."

And when radio came, it called for the same sort of manufacturing machinery, performing the same operations and run by the same experienced hands.

Perhaps the fact that we were ready, coupled with an earnest desire for precision and care, explains the confidence with which the Radio Industry regards Atwater Kent Receiving Sets and Radio Speakers.

ATWATER KENT MFG. CO.
Philadelphia

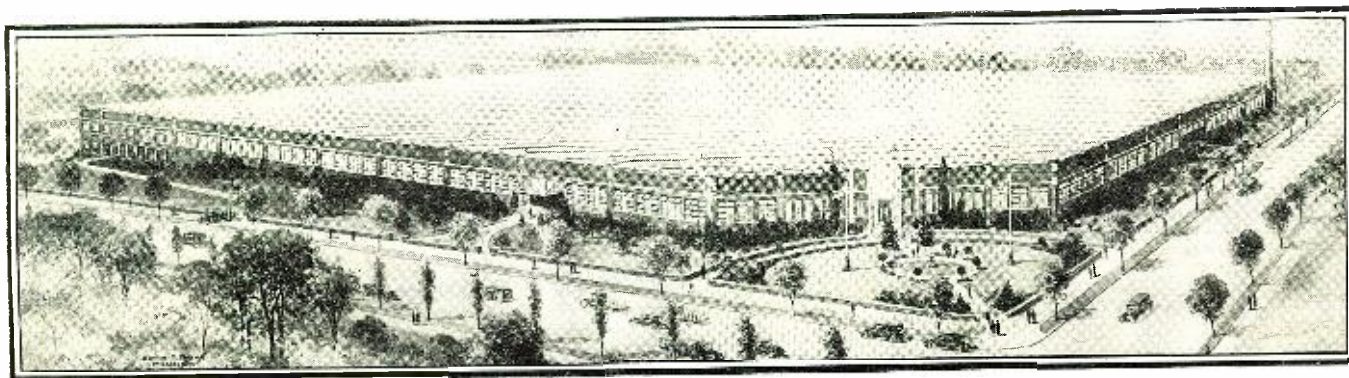



Your tubes know

**The Difference—
When Using AMPERITE**

AMPERITE the "self-adjusting rheostat", automatically controls the flow of current, and makes hand controlled rheostats obsolete.

Permits the use of any type of tubes or any combination of tubes.

Specified in every popular construction set.

For perfect results you must use AMPERITE for filament control. Price \$1.10 everywhere.

RADIALL COMPANY
Dept. R.N.-12, 50 Franklin Street, New York City

Write for **FREE Hook-ups**



AMPERITE
REG. U.S. PAT. OFF.

"means right amperes"

Radio Receiver KTS Catalog
Send To-day
FREE

YOU Need This Book



Your Own Kit Without Money Go Into Business For Yourself Book Explains How

7x10 ins. 36 Pages

Contains offers of large number of unequalled Radio Receiver Kits of one to eight tubes, which you can build in from one to several hours by the aid of our NEW "NO-SOLDER" SYSTEM which does away with bus bar and solder. Use only screwdriver and pliers. Please see big ad., page 12.

No money in advance—goods sent on approval—we pay transportation—satisfaction or money back.

RADIO SPECIALTY COMPANY
Kit Div. 679B, 245 Greenwich Street, New York City

Buy Now Pay Later

It's Easy to Build Things
—when your ripping, mitering, grooving, etc., are done on the

Boice-Crane Handisaw

Made in three sizes. Swings saws as large as 8" to cut 2 1/2" stock. Attachments for grinding, dadoing, sanding. Driven by any 1/4 to 1/2 h.p. motor. Attaches to light socket. Sold with or without motor.

Write today for descriptive catalog of Bench Saws, Drills, Jointers, Band Saws and the Boice E-Z-Pay Plan.



W. B. & J. E. BOICE
Dept. 807-A
Toledo, Ohio

Valley Battery Chargers
The Charger With Ten Points of Superiority



Mfgd. by Valley Electric Co., St. Louis, Mo. Sold by Radio Dealers Everywhere.

The bunch inside are still arguing. Then I steps in.

"Well, fellows, here goes my night's earnings on number thirteen," I states. "Any of you tin-horns game enough to come in with me?"

This is a man-to-man challenge, and they makes their biggest bets. When we're through, there's five thousand dollars bet on a ten-to-one shot. Then I signals Jerry, and the operator spins the wheel.

The gentlemen are sports!" calls the operator. "They risk their all on the turn of a wheel! The turn of a wheel! Watch closely, gentlemen, and see the wheel stop on—"

The concessionaire's face turns white, then red, then purple. *For the wheel stops on thirteen!*

I tells the boys to figure it out and beats it to Jerry.

"Follow me," I orders. "Bring a pocket flashlight!"

We goes around to where the broken wire is. It ain't but a few minutes' work to trace it across the street to an apartment house. In a few more minutes we finds the room.

I knocks, and a voice that sounds sorta familiar says to come in. We does, The Master with his Colt all carried. The control stuff is there, all right. Then I gets the jolt of the evening.

"Why, goodness goshness, if it ain't my little radio friend, Sir Arthur Haviland!"

And I'm right. In his shirt sleeves, and minus his half-hearted specs, he don't present such an imposing appearance. We're onto him, and The Master calls the cops. We hides in the room, keeping Haviland covered. Pretty soon there's a knock, and the operator enters, mad as a broadcast listener during a ham convention. He thinks he's been double-crossed, but we proves his error. Eventually the police comes, and we're rid of our prisoners.

We goes back to the tent and gets our money. Jerry takes the gambling wheel and we loads our stuff onto his truck. As we're riding home, The Master speaks.

"But just how'd you find that wire, Joe," he asks.

I explains about the hold-up. "The minute I saw that wire, everything was explained. In order to divert suspicion, they had their controlling outfit a block away, using a microphone transmitter and a telephone system to keep in touch with each other. That explains why the operator yelled so loud and often."

Jerry smiles approvingly. "Very good, Joe," he says. "And their transmitter was so much larger than mine that it drowned mine out. That explains why my set worked earlier in the evening, and not later."

"How about their machine?" I asks. "Have you smashed it up yet?"

Jerry laughs. "That won't be necessary. I know how it worked. The principle of magnetic attraction, with magnets, radio receivers and batteries all imbedded in the porcelain. Extremely clever."

"Yeh," I says.

We're quiet a moment. Then I laughs. "Pretty good," I says. "But the best part'll be when I tell Doris about her nobleman."

"Nobleman?" repeats Jerry.

I explains about Sir Arthur.

"He didn't understand when you called him a fan?" queries Jerry. "How odd!"

"Oh, he understood, all right," I assures. "His part of the game was to pose as a crowned head and entice folks down to the wheel. Clever."

The Master's musing. "By the way, Joe, how much did you lose in the holdup?"

"Exactly thirteen dollars," I grins.

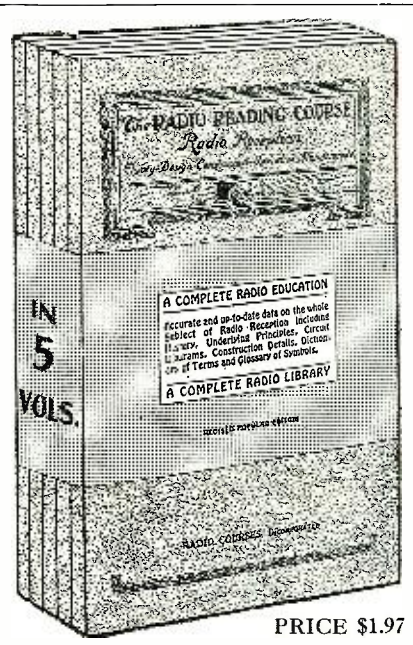

Radio Education
A COMPLETE RADIO EDUCATION
Accurate and up-to-date data on the whole subject of Radio—includes Incident History, Underlying Principles, Circuit Diagrams, Construction Details, Glossary of Terms and Glossary of Symbols.
A COMPLETE RADIO LIBRARY

IN 5 VOLS.

PRICE \$1.97

A RADIO EDUCATION

THEORY, DESIGN, CONSTRUCTION, OPERATION AND MAINTENANCE

IN 5 VOLUMES

LEARN AT HOME

These five component parts of a complete Radio Instruction Course are outlined in five volumes that contain not merely the essentials as so many books do, but more. They contain all that any modern up-to-the-minute textbook on any subject would cover. They are in themselves a COMPLETE radio education teaching every possible portion of Radio science.

Size of each book 6 by 9 inches, handsomely bound and illustrated with charts, diagrams, descriptions of equipment, etc.

SEND NO MONEY for these books. Just forward your name and address. We send you the books at once. On receipt of same you pay the postman \$1.97 plus a few cents postage and then they are yours.

Distributed by
The Consrad Co.
233 Fulton St. New York, N. Y.

UNCLE SAM The Coil Without Losses

MASTER TUNING COIL

Breaks through locals, gives a calibrated set, increases selectivity and volume and has tuned Hawaii from Philadelphia.

FREE 4 wiring diagrams for 4c in stamps
U. S. ELEC. CO., 211 E. Sixth St., Plainfield, N.J.



"Radio" with Volume and Distance

A "COLYTT" Adjustable Grid-Leak improves receiving. Proper value of leak in grid circuit—gives greater distance—louder and clearer signals.

Try a "COLYTT" Grid-Leak tonight. **MONEY BACK GUARANTEE.** Sent postpaid with full directions for \$1.00.

R.N. COLYTT LABORATORIES
565 West Washington Street, CHICAGO, ILL.



Insure your copy reaching you each month. Subscribe to **RADIO NEWS**—\$2.50 a year. Experimenter Publishing Co., 53 Park Pl., N.Y.C.

Stations Don't "Bunch" On the Dials

Showing stations "Bunched" as they are found on a 100 degree dial using any ordinary condenser.

The location of the same stations on the same dial using Ultra-LowLoss Condensers—"spread," simplifying tuning.

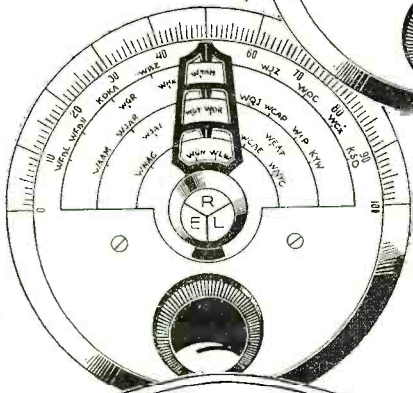
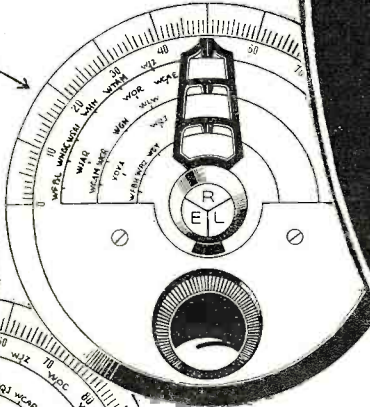

ULTRA-VERNIER TUNING CONTROL

Simplifies radio tuning. Pencil record a station on the dial—thereafter, simply turn the slider to your pencil mark and you get that station instantly. Easy—quick to mount. Eliminates fumbling, guessing. A single vernier control, gear ratio 20 to 1. Furnished clockwise or anti-clockwise in gold or silver finish.

Silver \$2.50

Gold \$3.50



This seal on a radio product is your assurance of satisfaction and a guarantee of Lacault design.

ULTRA-LOWLOSS CONDENSERS



\$5.00

PATENT PENDING

Tuning Simplified Now!

THE day of tedious fumbling about for your stations is past—science has been brought into play. Now, with the Ultra-LowLoss Condenser you can instantly tune in on any station as easy as turning the hands of a clock to the hour.

With one station of known wave length located on the dial, all others can be found instantly. Each degree on a 100 degree dial represents approximately $3\frac{1}{2}$ meters difference in wave length. This applies to both high and low wave lengths. Other than 100 degree dials vary accordingly.

This simplification of tuning is made possible by the new Cutless Stator Plates to be found only in the Ultra-LowLoss Condensers. Every feature of the Ultra-LowLoss Condenser was developed with one predominating purpose—to overcome losses common in other condensers. Designed by R. E. Lacault, originator of the famous Ultradyne Receivers and Ultra-Vernier Tuning Controls.

At your dealer's, otherwise send purchase price and you will be supplied postpaid.

Design of lowloss coils furnished with each condenser for amateur and broadcast wave lengths showing which will function most efficiently with the condenser.

To Manufacturers Who Wish To Improve Their Sets

Mr. Lacault will gladly consult with any manufacturer regarding the application of this condenser to his circuit for obtaining best possible efficiency.

ULTRA-LOWLOSS CONDENSER

PHENIX RADIO CORPORATION,

114 East 25th St.
New York City

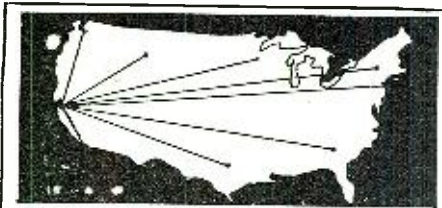

ON ONE TUBE

BIG FREE BOOKLET tells the story. California users of CROSS COUNTRY CIRCUIT hear Atlantic Coast, Canada, Mexico, Cuba and Hawaii. Our new plan makes this set easiest and cheapest to build. One hour puts in operation. One tuning control. No soldering. Any Novice can do it. BOOKLET FREE or complete instructions 25¢

WHAT USERS SAY

EAST—Am more than pleased with the parts ordered from you. The first night I hooked it up and received Omaha. Since then Minneapolis and Los Angeles. It works better without amplification than most sets with two stages. —Donals, S. C.
WEST—I am sending you a list of some of the stations heard on one tube: WSB, WGY, KDKA every night. PWX, WWJ, WTAM, WLW every night. CFAC, CHCB. Not long ago I purchased another set of parts from you and first night got WGR, Buffalo, and KDKA. —Tone, Calif.
NORTH—Received coils OK today. If I have same results with these that I had with last will be wanting more. I am 1,500 miles from nearest station and have picked 56 to date. Chicago, Havana, Mobile, New Orleans and TWO IN ENGLAND.—Lunenburg, Canada.
Vesco Radio Co. OAKLAND, CALIF.
 BOX RN-117

History of Radio Patents

(Continued from page 53)

when a ship is in South Latitude or East Longitude, where (except in the North Sea) the ether may be less congested.

There are already available very highly tone-selective receivers, relays and recorders and when, as seems likely, ships will, in certain cases, be required to transmit certain specified wave-train frequencies only, such devices will find a wide application. There are numerous methods—electrical, mechanical, acoustic, and their combinations—of adding the refinement of note to wave-tuning; but their applicability, and consequently their development, have been retarded, pending greater stability of note-governing conditions at the transmitter. The author has seen the Hall Air-Jet Relay (Figs. 23 and 24) (U. S. Pat. 1,160,072; Br. Pat. 144,250) satisfactorily operating a recorder, through jamming which made it almost impossible for a trained ear to read the desired signals.

(To be continued)

A Non-Radiating R. F. Receiver

(Continued from page 49)

of self-oscillation, where the amplification is greatest.

It may be well to present to our readers a new classification of radio frequency amplifiers which may assist materially in clearing the atmosphere about five-tube sets.

1. *The inefficient type.* This class includes all receivers which employ resistance to afford stability to the set.
2. *The inefficient type with positive feedback.* This is a considerable improvement over sets in the first type, for although the coupling between the stages is very loose and the transfer of energy between stages relatively small, the efficiency of the tubes has been raised by the feedback.
3. *The efficient type with negative feedback.* These circuits are built efficiently and have considerably more turns on the R.F. transformer primaries than the first two types, and are inherently good squealers. The squealing is stopped by means of the negative feedback.
4. *The efficient type with absorption circuits.* This type is built efficiently, but the squealing is prevented by absorption circuits coupled to the tuned circuits. The adjustment must be made on the short wavelengths, so that will give slightly less amplification on the long waves.
5. *The efficient type neutralized.* This is the type in which the circuit capacities have been neutralized by one means or another. It is probable that these circuits may not operate as close to the point of oscillation as they might otherwise, although this technical disadvantage is far outweighed by the greater efficiency of the circuits.

The first step is the construction of the radio frequency transformers. Each transformer employs a cardboard tube 3 inches in diameter and 4 inches long. One-half inch from one end a winding of 32 turns of No. 24 D.C.C. wire is begun and a space of 1/4 inch is left open, whereupon another winding of 32 turns, in the same direction, completes the secondary. In the space at the middle of the coil four turns of the same wire are placed and constitute the primary winding. The above procedure should be followed in building the three coupling transformers.

FOR GREATER DISTANCE, VOLUME AND CLARITY USE
X-L VARIO DENSERS
 Endorsed and Used by the Foremost Radio Engineers of the Country
MODEL N—Capacity range 1.8 to 20 micro-farads, for balance in Roberts two tube, Browning-Drake, McMundo Silver's Knockout, Neutrodyne and tuned radio frequency circuits. Price \$1.00
MODEL G—Two capacity ranges, .00016 to .00055 and .0003 to .0015 Microfarads, for the Cockaday circuit, filter and intermediate frequency tuning in super-heterodyne and positive grid bias in all sets. Price \$1.50
X-L RADIO LABORATORIES
 2426 Lincoln Ave. CHICAGO
 If your dealer cannot supply you write direct

The Five Tube Set which startled the World!
FRESHMAN MASTERPIECE
The Greatest Value Ever Offered in A Radio Receiving Set
At all dealers!

SILVER Dealers!
 Send for our new illustrated dealer's catalog, with latest wholesale and retail radio bargains. Also ask for our attractive proposition to radio dealers on nationally advertised lines.
SILVER-MARSHALL, Inc.
 105C S. Wabash Ave., Chicago

MARSHALL PATENTS WRITE for our Four Guide Books and "REC-ORD OF INVENTION BLANK" before disclosing inventions. Send model or sketch and description of your invention for our INSPECTION and INSTRUCTIONS FREE. TERMS REASONABLE. Electrical and Radio Cases a specialty.

VICTOR J. EVANS & CO.
 919 NINTH ST., WASHINGTON, D. C.

Operate your radio from your lamp socket with a
Gould UNIPower Battery
 for complete information address
GOULD STORAGE BATTERY CO.
 250 Park Avenue New York

RICHARDSON
5
Power

A five-tube, tuned radio frequency set equalized on all wavelengths to give great power, distance and volume. Consider its performance, its appearance and its price. No wonder it is making radio history wherever it is demonstrated.

\$65

At Better Radio Stores Everywhere
RICHARDSON RADIO, Inc.
 128 University Place, New York City

ELIMINATE Your STORAGE BATTERY
 For Reflex Radios
A. C. POLARIZER
 Uses Electric Light Current—saves your recharging costs and bother. First small cost of Blax is last. Nothing to get out of order. Thousands already giving satisfaction. Ask your Dealer.
SEND \$1. BILL or send dealer's name, along with yours and will forward C. O. D.
DEALERS AND SET MAKERS—WIRE FOR PROPOSITION.
BLACK BROS. Inc.
 500 BLACK BLDG. LOS ANGELES

The MOZART GRAND CO.
 Manufacturing fine
Radio Reproducing Apparatus
 at 235-49 Elizabeth Avenue,
 NEWARK, N. J., U. S. A.

Insure your copy reaching you each month. Subscribe to RADIO NEWS—\$2.50 a year. Experimenter Publishing Co., 53 Park Pl., N.Y.C.



The Simplest Practical Radio Set Made

\$2.50

A Complete Radio Receiver including Radiogem, Phone and Aerial

The Complete Outfit Consists of Three Parts

(One)

The RADIOGEM

The simplest radio outfit made—yet as practical as the most expensive. A crystal receiving set that you can operate and enjoy even though you know absolutely nothing about radio. You receive the RADIOGEM unassembled, together with a clearly written instruction book, which shows you how to quickly and easily construct the set, using only your hands and a scissors. The outfit comprises all the necessary wire, contact points, detector mineral tube on which to wind the coil, etc., etc. The instruction book explains simply and completely the principles of radio and its graphic illustrations make the assembling of the RADIOGEM real fun.

(Two)

The GEMPHONE

An adjustable, 1,000-ohm phone complete with 3-ft. cord—the first inexpensive adjustable receiver made. The Gemphone is of standard type and made of the very best grade of materials throughout. The case is made of turned wood, an exclusive feature with the "GEMPHONE." This is responsible for its exceptionally rich, and mellow tone. Like RADIOGEM, the GEMPHONE is sold unassembled. Our instruction pamphlet shows how to assemble it in two minutes, using only a screw driver.

(Three)

The AERIAL OUTFIT

Consisting of 100 ft. of standard copper aerial wire and two porcelain insulators.

- Complete Radiogem Outfits - \$2.50
- The Radiogem, only - 1.00
- The Gemphone, only - 1.00
- Aerial Outfit, only - .50

RAGEMCO

Radio Headquarters for the Finest and BEST Radio Tools



RADIO TOOL SET

This is the handiest set of tools ever made for Radio Work by the makers of the famous "YANKEE" Tools. It contains the following: 1 Ratchet Screw-driver, 6 1/2 in. long holding all attachments; 1 Blade, 3 1/2 x 3-16; 1 Blade, 3 1/2 x 3/8; 1 Blade 2 1/2 x 3/8; 1 Countersink; 2 Socket Wrenches for all small nuts; 1 Reamer to enlarge holes in panel from 3/8 x 1/2; 1 Wrench, one end 5-16" square or hex, for jack, other 1/2" hex., etc.
PRICE per set—No. 701\$3.00



HAND DRILL

The hardwood handle is hollow to store drills. Light frame, nickel-plated parts. Well bearing three jawed chuck holding and centering accurately pound shank drills from 0 to 3-16. Length of drill, 12 inches.
PRICE—No. 303\$2.25



WIREBENDING TOOL

For making eyes, loops, bends, and offsets on Bus Bar wire. With this device any Radio Constructor can wire his set to compare favorably with any factory made set. Easier to use and more accurate than pliers. Pull directions in box. Made of heavy steel, blued and finished.
PRICE—No. 203\$1.00



CIRCLE CUTTER

Especially designed for the Radio Constructor. Made of the finest material and equipped with the highest grade high steel cutting bits. It does three things at once. It drills its own pilot, cuts out plug and puts bead or scroll around the hole in one operation. Cuts holes 3/4 to 4 in. diam.
PRICE—No. 402\$3.00
401. Same tool but smaller and not fitted with bead or scroll in one operation.
PRICE—No. 401\$2.00



HAND DRILL

Especially designed for Radio Work by the makers of the famous "Yankee" Tools. A beautiful balanced, small, powerful drill with 4 to 1 ratio of gears for speed. Special chuck 9-32" capacity, to take largest drill, mostly furnished with drill or tool sets. Length over all, 9 1/2 in. Weight 1 1/2 lbs.
PRICE—No. 302\$2.75



Three-in-One Nut Wrench. Consists of handle with hollow stem 6 inches in length and three interchangeable sockets fitting popular sizes of nuts. The hexagon sockets grip the nut solidly.
PRICE per set—No. 30165c



Side Cutting Nipper, Lap Joint. For cutting all kinds of wire. Jaws hardened and oil tempered. Natural steel finish with polished jaws. Length 6 inches.
PRICE—No. 20175c

Order all tools by order number. All goods are shipped free of transportation charges to all parts of the United States and possessions the same day as the order is received.

MONEY REFUND GUARANTEE

If you are not satisfied money will be refunded on return of goods.

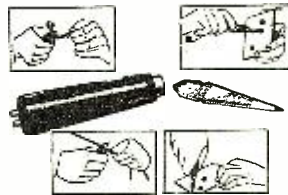

RADIO HANDI-TOOL

Bends Bus Bar or wire strips and scrapes wire, bores and reams holes, etc. Tool consists of 4 in. black japanned handle, to which is attached wire bending device, with nicked ferrule and 3 in. long two sided reamer.
PRICE—No. 70250c



TOOL CHEST

Set consists of "LOCK-GRIP" master handle, 5" long, black Rubberoid finish with steel chuck, nickel plated, buffed and with the following 9 tools: Saw, bradawl, large screwdriver, file, scratch awl, gimlet, reamer, chisel, small screwdriver. Each tool of fine steel, drop forged, tempered, hardened, and nicely finished. Set comes in leatheroid box with tray.
PRICE—No. 703\$1.85

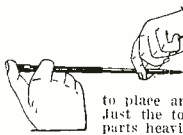

SCREW STARTER and DRIVER

Holds any screw by its slot with a firm grip, makes it easy to place and start screws in difficult places. Just the tool for the Radio Constructor. All parts heavily nicked and polished.
PRICE—No. 304\$1.00

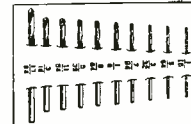

RADIO DRILL SET

Composed of 10 straight shank twist drills, fitting all hand and breast drills. The selection of these drills has been especially made for Radio Constructors and consists of the following sizes: 1-16, 5-64, 3-32, 7-64, 1/8, 9-64, 5-32, 11-64, 3-16, 17-64. Drills are mounted on white Holland Linen with sizes clearly marked.
PRICE—No. 305\$1.25



ELECTRIC SOLDERING IRON

A perfect tool for Radio Work. Operates either on 110-volt A.C. or D.C. The heat element is of Nichrome, which prevents overheating and assures the desired even temperature. Size of Iron, 10 1/2 in. long. A 4-ft. cord and plug is furnished.
PRICE—No. 800\$2.00



Combination Plier, Wire Cutter, Wire Former and Wrench. Drop forged, slender but exceptionally strong. 6 in. long.
PRICE—No. 20275c

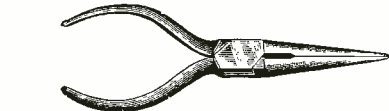

Long Sharp Nose, Side Cutting Pliers. Just the pliers for the radio constructor. Bends and cuts all kinds of soft wire. Nose 1 1/2 inches long, black body, polished jaws. Length 5 1/2 inches.
PRICE—No. 20075c

The RADIOGEM CORP., 66-R W. Broadway, New York

Popularity of Summer Radio is Increasing

The use of Kellogg transformers in your set will prove a delight in clear, powerful reception.

Kellogg radio frequency transformers are of the low loss, high efficiency type. No "dope" to hold windings in place. Minimum amount of insulating material. No. 603 for selective tuning. No. 602 when exceptional selectivity is not desired.

Kellogg audio frequency transformers are built right for the kind of service you expect. They amplify the highest or lowest tones with absolute fidelity. Built in 3 and 4½ to 1 ratios.

Kellogg transformers are on sale at all radio dealers. Their use with Kellogg low loss condensers will give you an ideal tuning and amplifying combination for your set, with results that will be most pleasing.



**Kellogg Switchboard
& Supply Company**
Chicago, Illinois



\$3.50
12 Cells
24 Volts
**RADIO
Storage "B" Battery**
Lasts Indefinitely—Pays for Itself

Economy and performance unheard of before. Recharged at a negligible cost. Approved and listed as Standard by leading Radio Authorities, including Pop. Radio Laboratories, Pop. Sci. Inst. Standards, Radio News Lab., Lefax, Inc., and other important institutions. Equipped with *Solid Rubber Case*, an insurance against acid and leakage. Extra heavy glass jars. Heavy rugged plates. Order yours today!

SEND NO MONEY Just state number of batteries wanted and we will ship day order is received. **Extra Offer:** 4 batteries in series (96 volts), \$13. Pay expressman after examining batteries. 5 per cent discount for cash with order. Mail your order now!

WORLD BATTERY COMPANY
1219 So. Wabash Ave., Dept. 75, Chicago, Ill.
Makers of the Famous World Radio "A" Storage Battery
Prices: 6-v., 100 Amp. \$11.25; 120 Amp. \$13.25; 140 Amp. \$14.00. All equipped with Solid Rubber Case.

World FOR RADIO
STORAGE BATTERIES
KIKVA WEA WGN WJS KHL KSO KFAF WJY KOP

WANTED

In Every Locality

An agent to sell Biltmore Master Reflex receivers to dealers, on our plan which allows the dealer to make summer profits equal winter profits.

"The receiver with the Guaranteed Best Tone."

BILTMORE RADIO COMPANY
Boston 30, Mass. Dept. N.

After the four wires are brought to connection terminals on the bottom of the tube, the three transformers are mounted on the baseboard at a distance of 8 inches between centers. The first is equipped with a small rotor 1½ inches long and 1⅞ inches in diameter upon which is wound four turns of wire. The second transformer is likewise equipped with a similar coil whose ends are connected, thus forming a closed circuit. The third transformer is complete as it is.

A 12-inch length of fibre rod, which has a small knob fitted to it at one end, is passed through the top section of the first and second transformers and is the means of mounting the stabilizing coils. The position of the coils on this rod will have to be determined from experiment and, when once adjusted, will need no further attention. As can be seen from the photo, the layout of the apparatus is the same as was used in the set described in the May issue. The builder will therefore need to make very few changes in his first set, if he carefully follows the directions given in this article.

The improvements as specified above are a few of the developments being made in the Laboratory and our readers will be informed as to further progress as time goes on.

The Life and Works of Lee DeForest

(Continued from page 27)

the Straits of Magellan. He told graphically how the fleet had encountered rough weather about three days before they rounded the Horn and how, from the bridge of the Flagship, the commanding officers had guided the flock of destroyers following simply by throwing on one switch and talking into a regulation telephone transmitter. It looked simple and seemed to work well. He showed them endless newspaper accounts of the eventful trip and repeated at length interviews he had had with various commanding officers of the fleet who considered the new radio phone a boon to humanity.

The Britishers, however, wanted to be convinced. So DeForest decided that convinced they should be. He asked for a couple of boats upon which to try it in full view of the staff of the whole British Navy, if necessary.

Accordingly, a couple of days later the general order went out from the Admiralty office in London that the Americans were to be allowed to try their new radio telephone aboard His Majesty's ships, *Vernon* and *Furious*.

Immediately, DeForest and his assistants moved their base of operations to Portsmouth where the ships were in port. The installation of the apparatus was a matter of only a few days, and in less than a week the officers in charge of the test were notified that all was in readiness and that they were at liberty to view the installations and a demonstration at their convenience.

40-MILE COMMUNICATION ESTABLISHED

The tests were a huge success. The *Furious* steamed out of the harbor and swung up and down. For two solid days DeForest and his assistants remained at their posts of duty, telling off all sorts of messages and allowing the operators of the navy to have full charge of the apparatus. The two little sets kept the big battleships in constant communication over a distance of forty miles all of the time the tests were going on. Never once did it fail, through all sorts of interference; the contact was perfect, DeForest did not have to alibi his apparatus once.

Everyone seemed perfectly satisfied and

KIED STORAGE "B" BATTERY
"B" ELIMINATOR SIMPLICITY
PERMANENT ALKALINE STORAGE BATTERY RECEPTION
KIC-O MULTI-POWER UNITS operate from your lighting line and eliminate the replacing of dry cell "B" batteries—usually saving their cost in the first six to twelve months of service on Neutrodyne and Super Heterodyne sets.
Its RECHARGER is attached to back.

Guaranteed Two Years
PRICES Recharger Included.
130 volt P. U. \$43.50 Complete
100 volt P. U. \$35.00 Complete
100 volt C. U. \$32.50 Complete
Our latest contribution to better Radio. Don't wait for imitations. Write! Write NOW! Dealers! Everybody!

Kimley Electric Company, Inc.
2665 Main Street Buffalo, N. Y.

BUILD AN ALL WAVE RECEIVER

LISTEN TO KDKA ON 64 Meters

WASHBURN INTERCHANGEABLE COIL TUBE RADIO REBUILDING KIT
40-180 METERS
KIT NO. 2-100 to 300 METERS
KIT NO. 3-224 to 555 METERS

INTERCHANGEABLE COILS
Each kit contains three matched low loss interchangeable coils; complete diagram and wiring instructions for building five tube tuned Radio frequency set. Interchangeable coils are mounted in Bakelite bases designed for use in standard tube sockets. Kit No. 1—40 to 180 meters, \$7.00; kit No. 2—100 to 300 meters, \$8.00; kit No. 3, 224 to 555 meters, \$9.00.

THE WASHBURN BURNER CORP.
Kokomo Indiana

\$3 Brings you a Genuine UNDERWOOD TYPEWRITER

10 DAYS FREE TRIAL Your \$3.00 unconditionally returned if at end of 10 days you are not satisfied with this late model UNDERWOOD typewriter rebuilt by the famous Shipman Ward process.

GREAT PRICE SAVING Direct to you from the largest typewriter factory in the world by our money saving methods.

EASY MONTHLY PAYMENTS So small that notice it while you enjoy the use of this wonderful machine.

FREE BOOK OF FACTS Explaining Shipman Ward's wonderful system of rebuilding typewriters and also valuable information about the typewriter industry both instructive and entertaining.

Act Today! Mail Coupon

5 Year Guarantee

Shipman Ward Mfg. Company
1195 Shipman Building
Montrose & Ravenswood Aves., Chicago

Name.....
St. and No.....
City..... State.....

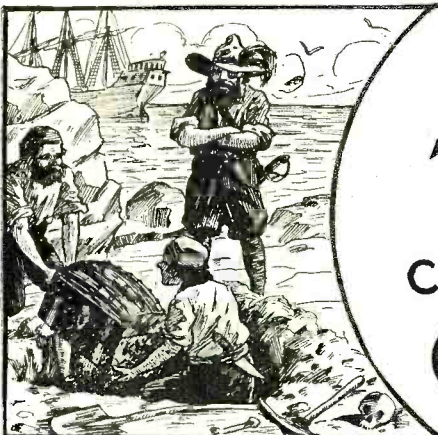

BURIED TREASURE

can still be found in

CHEMISTRY



Good Chemists Command High Salaries

and you can make yourself independent for life by unearthing one of chemistry's yet undiscovered secrets.



T. O'CONNOR SLOANE,
A.B., A.M., LL.D., Ph.D.
Noted Instructor, Lecturer and Author. Formerly Treasurer American Chemical Society and a practical chemist with many well known achievements to his credit. Not only has Dr. Sloane taught chemistry for years but he was for many years, engaged in commercial chemistry work.

Do you remember how the tales of pirate gold used to fire your imagination and make you want to sail the uncharted seas in search of treasure and adventure? And then you would regret that such things were no longer done. But that is a mistake. They *are* done—today and everyday—not on desert islands, but in the chemical laboratories throughout your own country. Quietly, systematically, the chemist works. His work is difficult, but more adventurous than the blood-curdling deeds of the Spanish Main. Instead of meeting an early and violent death on some forgotten shore, he gathers wealth and honor through his invaluable contributions to humanity. Alfred Nobel, the Swedish chemist who invented dynamite, made so many millions that the income alone from his bequests provides five \$40,000 prizes every year for the advancement of science and peace. C. M. Hall, the chemist who discovered how to manufacture aluminum made millions through this discovery. F. G. Cottrell, who devised a valuable process for recovering the waste from flue gases, James Gayley, who showed how to save enormous losses in steel manufacture, L. H. Baekeland, who invented Bakelite—these are only a few of the men to whom fortunes have come through their chemical achievements.

What Some of Our Students Say of This Course:

I have not written since I received the big set. I can still say that it far exceeded my anticipations. Since I have been studying with your school I have been appointed chemist for the Scranton Coal Co. testing all the coal and ash by proximate analysis. The lessons are helping me wonderfully, and the interesting way in which they are written makes me wait patiently for each lesson.—**MORLAIS COUZENS.**

I wish to express my appreciation of your prompt reply to my letter and to the recommendation to the General Electric Co. I intend to start the student engineering course at the works. This is somewhat along electrical lines, but the fact that I had a recommendation from a reliable school no doubt had considerable influence in helping me to secure the job.—**H. VAN BENTHUYSEN.**

So far I've been more than pleased with your course and am still doing nicely. I hope to be your honor graduate this year.—**J. M. NORKUS, JR.**

I find your course excellent and your instruction, truthfully, the clearest and best assembled I have ever taken, and yours is the fifth one I've studied.—**JAMES J. KELLY.**

From the time I was having Chemistry it has never been thus explained to me as it is now. I am recommending you highly to my friends, and urging them to become members of such an organization.—**CHARLES BENJAMIN.**

I shall always recommend your school to my friends and let them know how simple your lessons are.—**C. J. AMDAHL.**

I am more than pleased. You dig right in from the start. I am going to get somewhere with this course. I am so glad that I found you.—**A. A. CAMERON.**

I use your lessons constantly as I find it more thorough than most text books I can secure.—**WM. H. TIBBS.**

Thanking you for your lessons, which I find not only clear and concise, but wonderfully interesting. I am.—**ROBT. H. TRAYLOR.**

I received employment in the Consolidated Gas, Co. I appreciate very much the good service of the school when a recommendation was asked for.—**JOS. DECKER.**

Now Is the Time to Study Chemistry

Not only are there boundless opportunities for amassing wealth in Chemistry, but the profession affords congenial employment at good salaries to hundreds of thousands who merely follow out its present applications. These applications are innumerable, touching intimately every business and every product in the world. The work of the chemist can hardly be called work at all. It is the keepest and most enjoyable kind of pleasure. The days in a chemical laboratory are filled with thrilling and delightful experimentation, with the alluring prospect of a discovery that may spell Fortune always at hand to spur your enthusiasm.

You Can Learn at Home

To qualify for this remarkable calling requires elaborate specialized training. Formerly it was necessary to attend a university for several years to acquire that training, but thanks to our highly perfected and thorough system of instruction, you can now stay at home, keep your position, and let us educate you in Chemistry during your spare time. Even with only common schooling you can take our course and equip yourself for immediate practical work in a chemical laboratory. Dr. Sloane gives every one of his students the same careful, personal supervision that made him celebrated throughout his long career as a college professor. Your instruction from the very beginning is made interesting and practical, and we supply you with apparatus and chemicals for performing the fascinating analyses and experimental work that plays such a large part in our method of teaching, and you are awarded the Institute's official diploma after you have satisfactorily completed the course.

Easy Monthly Payments

You don't have to have even the small price of the course to start. You can pay for it in small monthly amounts—so small that you won't feel them. The cost of our course is very low, and includes everything, even the chemistry outfit—there are no extras to buy with our course. Our plan of monthly payments places a chemical education within the reach of everyone. Write us and let us explain our plan in full—give us the opportunity of showing you how you can qualify for a highly trained and technical position without even giving up your present employment.

Special 30 Day Offer

Besides furnishing the student with his Experimental Equipment, we are making an additional special offer, for a short while only. You owe it to yourself to find out about it. Write today for full information and free book "Opportunities for Chemists." Send the coupon right now while it is fresh in your mind. Or just write your name and address on a postal and mail it to us. But whatever you do, act today before this offer is withdrawn.

CHEMICAL INSTITUTE OF NEW YORK
Home Extension Division 7
66-R—West Broadway
New York City



Experimental Equipment Furnished to Every Student

We give to every student without additional charge this chemical equipment, including forty-nine pieces of laboratory apparatus and supplies, and forty different chemicals and reagents. These comprise the apparatus and chemicals used for the experimental work of the course. The fitted heavy wooden box serves not only as a case for the outfit but also as a useful laboratory accessory for performing countless experiments.

CHEMICAL INSTITUTE OF NEW YORK, Inc.

HOME EXTENSION DIVISION 7

66-R—WEST BROADWAY

NEW YORK CITY

NAME

ADDRESS

CITY

STATE

Miller AMPLIFYING HORNS

35 Different Horns
Others In Process of Development

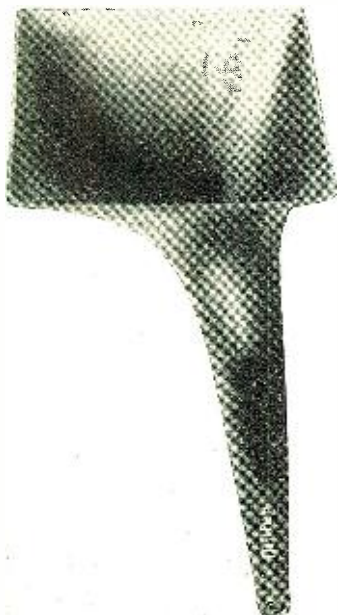

**PROPER DESIGN—
CORRECT MATERIAL—
UNEXCELLED SERVICE—**

These outstanding features are responsible for Miller being the leading maker of amplifying horns in the country. Because of them, the best radio manufacturers, one by one, are making Miller Horns their standard equipment.

The new Miller line of horns, including 35 different shapes, has taken the radio industry by storm. The exceptionally high quality is not the result of accident—but of long and careful study in the field of acoustics, backed by the enormous resources of The Miller Rubber Company. Years of experience have made it possible to meet the exacting requirements of radio manufacturers.

There is a Miller Horn to fit your receiving set. Let our engineers assist you in solving your problems in acoustics.

The Miller Rubber Co.
Akron of N. Y. Ohio

DeForest and his assistants retired to their hotel in London in perfect confidence that a large order for equipment and installation would be forthcoming in the least possible time. But on account of certain political implications which were made and other conditions which were in the hands of professional politicians, DeForest is still waiting for the order. It never came.

Having some private notions as to the inside operation of the purchasing departments of governments, mostly gained through personal experience with three or four of them, DeForest was not disheartened by this failure to receive the commission. Instead, he rushed back to New York.

FIRST GOOD ANTENNA

When he reached American shores again the Metropolitan Life tower, across from Madison Square Garden, was just being completed. DeForest immediately saw the possibilities of a really good radio antenna.

A short discussion of the matter with the directors of the Metropolitan Life Insurance Company convinced them of the publicity value of the stunt and they consented to the placing of the antenna on the tower. Accordingly the architect was told of the scheme and he very obligingly placed a series of bronze hooks just under the clock balcony. The hooks are still there, as a more or less permanent memento to the first real attempts at radio telephony made.

The station was placed in the pent-house atop the left wing of the building. The antenna leads ran directly from the window of the pent-house to the hooks under the balcony on the tower. The size of the wire which might be used in the construction of the antenna was restricted since the directors of the Metropolitan Company did not wish it to be noticeable from the street, lest it mar the beauty of the building.

DeForest moved the laboratory and chief workshop of the company to new quarters in a building at 102 Park Avenue. The work on the telephone was continued and DeForest had dreams of increasing the power input available to the set. Until this time the consumption at its greatest had been a little more than one-half kilowatt. The old bug-bear of modulation still existed and had to be solved before the use of much more power could be introduced. There were a number of multiple microphones available, but none of them worked with any degree of perfection. However, DeForest and his crew of helpers kept at the question and were hoping to solve it.

The Eiffel Tower had given him a dream and he began to work toward it. From the time of his return from the demonstration of the radio telephone to the officers of the British Admiralty until the thing was actually accomplished, DeForest was working toward the spanning of the Atlantic with the human voice. It was almost seven years later that the dream actually came true, but when the great day was finally heralded, it was made possible through the little vacuum valve which DeForest had perfected and spent so much of his time in making possible.

But when the new laboratory was installed at the Park Avenue building, of course, one of the first steps taken was the installation of a huge antenna on the top of the structure.

He continued his work and the company continued to prosper to a certain extent. Then DeForest had the grand idea. "Why not," he thought, "put a little grand opera on the air for the benefit of the listening few and see just what the result will be?" Consequently, he stepped to the greatest musical organization in the world for his talent. He went to the Metropolitan Opera House.

CARUSO BROADCASTS

To those who are acquainted with the situ-

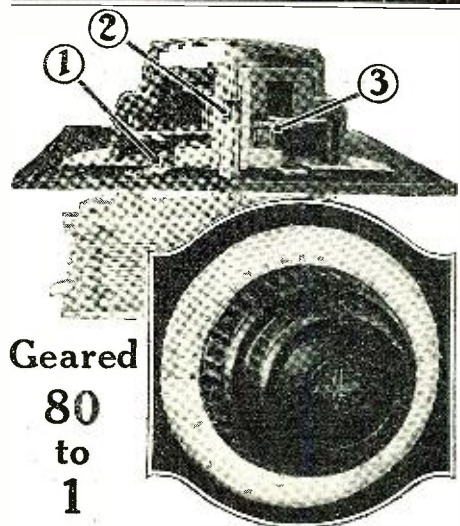

**Geared
80
to
1**

Close Tuning Features

(1) Friction Clutch—the heart of Accuratune Controls. Automatically locks gear train for coarse adjustment and throws train into operation for fine adjustment.

(2) Long center bushing gives maximum shaft-bearing surface and prevents all wobble.

(3) New Gear Mesh assures perfect alignment of the new brass gear train.

At your dealers, otherwise send price (\$3.50) and you will be supplied postpaid. Write for descriptive folder.

European Branch Office: Gaston E. Marbaix, 27 Anning St., London, E.C.2

Mydar Radio Company, 9-F Campbell St., Newark, N. J.

ACCURATUNE
REGISTERED GEARED 80:1 U.S. PAT. OFF.
MICROMETER CONTROLS

Radio Receiver KITS Catalog

FREE

Send to-day

**YOU
Need
This
Book**

**7x10 ins.
36 Pages**

Your Own Kit Without Money Go Into Business For Yourself Book Explains How

Contains offers of large number of unequalled Radio Receiver Kits of one to eight tubes, which you can build in from one to several hours by the aid of our NEW "NO-SOD-ER" SYSTEM which does away with bus bar and solder. Use only screwdriver and pliers. Please see big ad., page 12.

No money in advance—goods sent on approval—we pay transportation—satisfaction or money back.

RADIO SPECIALTY CO.
Kit Div. 679A, 245 Greenwich Street, New York City

BLANK CARTRIDGE PISTOL

Protection Against Burglars, Tramps and Dogs



Well made and effective; modelled on latest type of Revolver; appearance alone is enough to scare a burglar. When loaded it may be as effective as a real revolver—without danger to life. It takes standard .22 Calibre Blank Cartridges obtainable everywhere. Price \$1.00 postpaid. Blank Cartridges, by express, 50c per 100. Holster (Cowboy type) for Blank Cartridge Pistol, 50c. JOHNSON, SMITH & CO., Dept. 387, RACINE, WIS.

New Catalog
Send 25c for new
De Luxe Catalog
of Novelties,
Tricks, Puzzles,
Sporting Goods,
etc. 420 pages.
Handsome
binding.

"AIR ROAMER"

A McCall Compensated Circuit set, simple to operate, extremely selective, giving true tones, rugged and economical. Write for details.

KILBOURNE & CLARK MFG. CO.
Seattle, Washington

BRANCHES: Portland, Ore.; Los Angeles; San Francisco. Distributors: Pacific Electric Co., Sydney, Australia.

The Traffic Cop of the Air

**FERBEND
Wave Trap**

Add a Ferbend Wave Trap to your Radio Set and "Police" your reception. Regulate traffic. Guaranteed to tune out any interfering station. Widely imitated but never equalled. The original and only successful WAVE TRAP. Now in its third year. Sent Postpaid upon receipt of \$3.50 or C. O. D. plus postage. Send for Free Booklet **FERBEND ELECTRIC CO.** 25 E. So. Water St. Chicago

Insure your copy reaching you each month. Subscribe to RADIO NEWS — \$2.50 a year. Experimenter Publishing Co., 53 Park Pl., N.Y.C.

Some Popular 1925 Standard Models

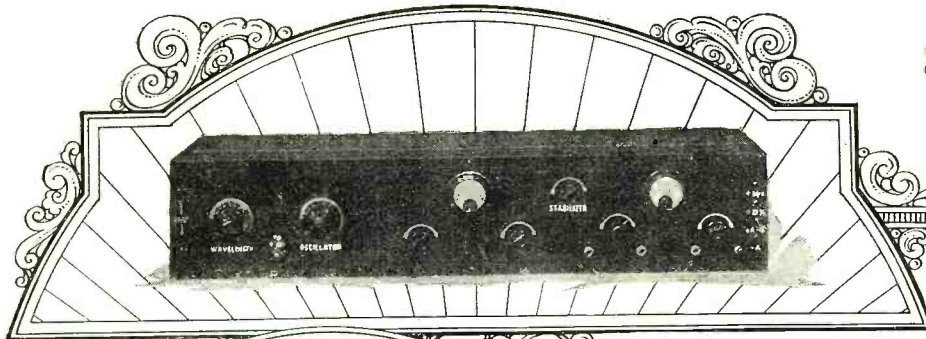

The superheterodyne—a late model. This is a type of circuit very popular with long distance fans and those who require good volume. Employs eight tubes and is easy to construct at home.



R. E. Lacault, A.M. I.R.E., the well-known radio engineer, designed and developed the "Ultradyn" shown above. It is a six tube receiver with splendid power, easy to wire and construct. The latest in 1925 radio models.

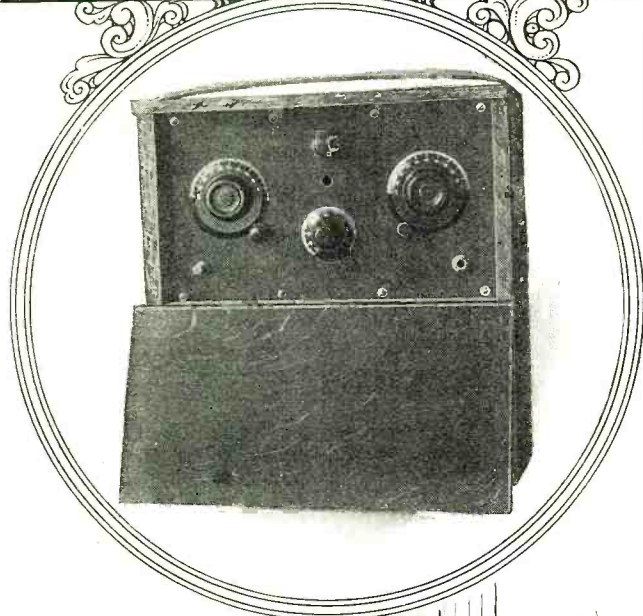

Here is something novel yet very popular in high powered radio receivers—the Tropadyne. Six tubes, equipped with trophaformers, operates from loop and reproduces beautifully.

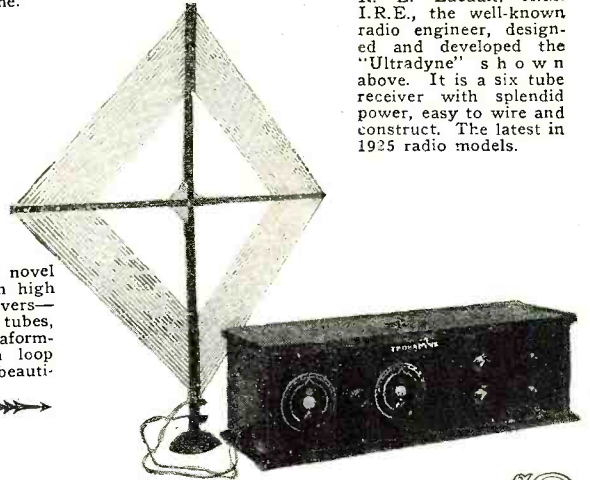

The popularity of the portable is spreading daily—that's because they have been perfected for 1925. Above is one of the season's most successful models, neat, light and easily carried.

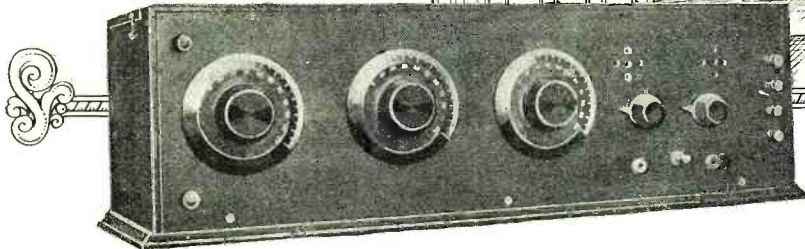
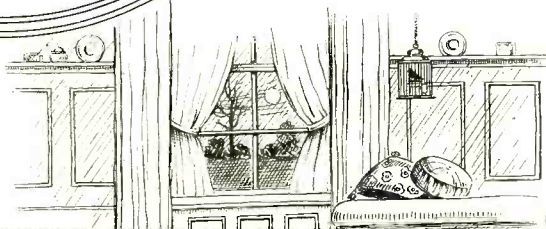

Countless thousands of radio fans throughout the country are Neutrodyne boosters. It is the 1925 ultimate in perfect reproducing radio receivers.

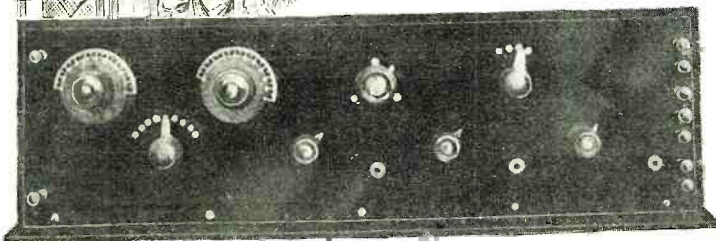

↑ Lawrence M. Cockaday, one of the best known radio engineers, is responsible for the five tube Cockaday receiver shown above. It is replete with the recent radio improvements and is extremely compact.

And lastly, here's one of the famous low-loss receivers of recent design that is built entirely along the lines of current conservation. It is an ideal outfit for the man who would like to build a thoroughly satisfactory receiver for home use.

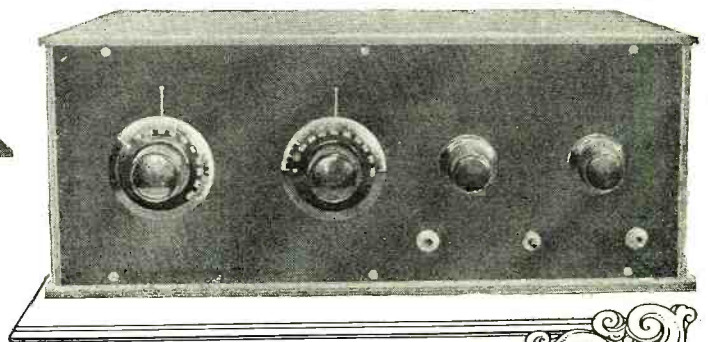

THE seven model receivers shown on this page represent perhaps the most select array of efficient, low cost, radio receivers on the market today. In fact, every one of them is so compact and complete that it can be built right at home with a few small tools and a few evenings' work.

Now is the time to select the receiver you want and start building. There are complete instruction booklets and full size blueprints on all receivers on this page. Price 50c each. You can obtain them at all radio stores or by writing direct to

The Consrad Company, Inc.
233 Fulton St., New York, N. Y.

Alfred Graham & Co.,
London, England,
Patentees.



**\$13.50
AND UP**

HEAR THE AMPLION—in comparison! You will then understand why, the world over, it is the largest seller. Created by the originators and oldest makers of loud speakers. The Amplion is supreme for sensitivity, clarity, natural tone and volume. As your ears will tell you. Write for literature and dealer's name.

THE AMPLION CORPORATION OF AMERICA
Executive Offices: Suite W,
280 Madison Ave., New York City.
Canadian Distributors:
Burndept of Canada, Ltd., Toronto

AMPLION
The World's Standard
Loud Speaker

"If it's natural and clear, it's the Amplion you hear."
The World's Standard Loud Speaker

IMPROVE Your Summer Tuning with E-Z-TOON



E-Z-TOON dials will improve the tuning of any radio set. Replace your old dials with E-Z-TOON and marvel at the simplicity of tuning—takes but a moment to install—a fine smooth 80 to 1 Vernier adjustment. 3 in. dia. Black, \$2; Mahogany, \$2.20. 4 in. Black, \$2.25; Mahog. \$2.45. 2 in. non-Vernier dials for rheostats, switches, etc., Black, 40c, Mahog. 45c. If your dealer cannot supply, write us.

E-Z-TOON RADIO COMPANY
323 1/2 W. Washington St., Indianapolis, Ind.
"The Key to Simplified Tuning"

Radio Instruction

Practical training for Radio Operators, Radio Mechanics, and Radio Dealers.

Send for 36 page booklet "Radio for Ambitious Men"

Resident and Home Study Courses.

Y. M. C. A. RADIO INSTITUTE
158 East 86th St., New York City

INSIST UPON



RHEOSTATS

FOR ALL TYPES OF TUBES

ation of broadcasting works of the same organization today, it might be said here that Andreas Dippel was at that time co-impressario with the inimitable Gatti—Gatti-Casazza. The latter gentleman is noted throughout the world for his conservatism in some lines and his absolute openmindedness in others. Dippel saw the possibilities of the scheme and made the necessary business arrangements for the operation of it.

DeForest was overjoyed. He harked back to the old, almost foodless days in Chicago when he would take his last cent and spend it for a seat up under the eaves of the Chicago Opera House. Now he was no longer the starving, penniless youth that he had been. He had seen a great many of his schemes come into actual being, he had watched the growth of the idea upon which he had pinned his faith from the time it was nothing more than a plaything until it had grown to be a great commercial enterprise. He was now going to the opera again, but he was going as some part of it. He was doing something which might, in time to come, give advantage of the greatness of music to many a young fellow in a position parallel to his of the Chicago days.

Through the co-operation of the Acousticon company, DeForest was able to put a couple of microphones on the stage and in the wings. The opera selected for the first bill was actually two operas. It was one of the Met's usual double bills. It consisted of "Pagliacci" and "Cavalleria Rusticana." Caruso was appearing in the former and Mme. Mazcarimi in the latter. The chief arias were allowed to pass to the little half-kilowatt arc telephone which was installed in a vacant room at the top of the Opera House. The antenna was suspended from two bamboo fish poles—the tallest that could be obtained—which were wired to vent pipes. There were listeners-in at the Park Avenue laboratory, at the Metropolitan Life Building and at the Newark plant of the DeForest Company, supplemented by various engineers, amateurs and a special installation at one of the hotels in the Times Square district.

NOTE:—That it may be fully understood that DeForest was cognizant of the possibilities of the work he was engaged in, it might be well to quote one of his statements made for the press at the time of the beginning of the around-the-world trip by the fleet.

It says: "Now comes the eternal question of the utilitarian: 'What's the use?' the most pertinent question, by the way, ever asked. What is the use of erecting a wire and speaking a spirit whisper—lassoing a ghostly voice, with a metal noose, of attuning a new zeolean harp and having it vibrate, not to the lawless songs of the wind, but to the will of a master musician playing in a great auditorium?"

"What is the use, when some distant mariner, fog-bound and lost, unacquainted with his bearing and the Morse code, can call to a listener on the nearest shore and hear, in a still, small voice, his name repeated and his whereabouts disclosed—or perhaps hear an answering 'Ahoy', and avoid certain collision by learning that another craft, steering a certain course, is close upon him!

"What's the use when a tug's captain can be in easy telephonic communication with the steersman of his tows or with his barge office, miles away?

"Or when the admiral on his bridge can give his orders direct to any or all of his commanders in his scattered squadron? Or when a yacht owner, without the useless luxury of a Morse operator in his crew, can call his club miles away on the shore? Farmers in sparsely settled rural districts can now subscribe to a certain telephone exchange and be in close contact with distant neighbors miles away.

"I am now at work on an apparatus of larger power and, before the season is over, I

**35% to 100%
Better Reception
For only \$12**

You pay from \$75 to \$500 for a radio set. You can add 35% to 100% to the value of that investment by paying only \$12 for—

The Super-Booster

It greatly increases distance and volume, sharpens selectivity and doubles the life of batteries and tubes. Effective with Super-Heterodyne or other loop-antenna set.

Beautiful mahogany cabinet, 9" x 4 1/2" x 5". Placed on top of set. No batteries or tubes. No connections to the set. Eliminates interference and increases the life of tubes and batteries. Makes ANY set more selective.

Price \$12, delivered anywhere in U. S. Sent C. O. D., or on receipt of money order.

**DEALERS WRITE
SUPER-BOOSTER
DISTRIBUTING CO.**
2528 W. Seventh St., Los Angeles

PATENTS

To the Man with an Idea

I offer a comprehensive, experienced, efficient service for his prompt, legal protection and the development of his proposition. Send sketch, or model and description, for advice as to cost, search through prior United States patents, etc. Preliminary advice gladly furnished without charge. My experience and familiarity with various arts frequently enable me to accurately advise clients as to probable patentability before they go to any expense. Booklet of valuable information and form for properly disclosing your idea free on request. Write today.

RICHARD B. OWEN
PATENT LAWYER
2 Owen Building, Washington, D. C.
2726A Woolworth Bldg., N. Y. City

PATENTS

If you have an invention and desire to secure a patent, send for our Evidence of Invention Blank and free guide book, "HOW TO GET YOUR PATENT." Tells our Terms, Methods, etc. Send model or sketch and description of your invention for INSPECTION and INSTRUCTIONS.

No Charge for the Above Information

RANDOLPH & CO., Dept. 459 Washington, D. C.

PATENTS

DON'T LOSE YOUR RIGHTS
Before disclosing your invention to anyone send for free blank form "EVIDENCE OF CONCEPTION" to be signed and witnessed.
LANGASTER & ALLWINE
Reg. Pat. Attys. in U. S. and Canada
270 Ouray Bldg., Washington, D. C.
Originators of the form: "Evidence of Conception"

Insure your copy reaching you each month. Subscribe to **RADIO NEWS** — \$2.50 a year. Experimenter Publishing Co., 53 Park Place, N. Y. C.

am positive that radio telephony over distances of twenty-five miles will be a commercial reality."

"Still another feature of the invention, or rather the benefit that may be derived from it, is the supplying of music and other forms of entertainment to passengers traveling on the passenger vessels. A service of this kind, aided by a huge receiver so that all of the passengers gathered in a large salon could hear the music or operatic airs simultaneously, should prove a most welcome innovation for steamship travelers. It is within the range of possibilities, at an early date, that the traveler by Great Lakes steamer may be able to spend his evenings listening to the voices of Caruso or Melba simultaneously with the audiences who see the singers in person at Covent Garden, London, or the Metropolitan or Manhattan Opera Houses in New York."

"Idle words"—that was the comment of many of those engaged in the wire telephone and telegraph companies as well as in the field of commercial wireless. How little did these men foresee what was to come through the art of radio broadcasting!

New Uses for the Vacuum Tube

(Continued from page 24)

has been utilized in an earthquake recorder or seismometer. In a region where earthquake shocks are frequent, interesting experiments could be made with this arrangement. If the beam of light from the galvanometer mirror were focused on a slowly moving strip of photographic paper, properly shielded from stray light, a permanent, continuous record of the earth tremors could be obtained.

A FEW HINTS

The following suggestions ought to be useful to any experimenter who wishes to set up a zero shunt ultra-micrometer: Although the descriptions of this article have referred to a tuned grid circuit, any one of the circuits of Fig. 1 may be used with success, the Hartley circuit giving a particularly sensitive result. An ordinary variometer may be used in place of the special bare wire coils described above. Although the bare wire coil is very convenient, more compact coils can be built with about 150 turns of enamelled No. 28 wire on a four-inch tube. A pair of these coils, best wound in a flat or "pancake" form, are required. If difficulties are experienced from "body capacity," that is, if the galvanometer deflections vary with the movements of the operator near the set, an improvement will be brought about by introducing a condenser of several tenths of a microfarad capacity between the plate terminal of the tube and the point A, Fig. 5. Although with this set no serious shielding difficulties are to be expected, there are, nevertheless, certain other troubles to be looked for. It is very evident that drifting in the plate battery voltage or in the voltage of the small battery E, Fig. 5, will cause the galvanometer reading to creep. A similar effect will be caused by temperature changes in R. The greatest care must be taken to assure prime condition of the plate batteries and of the battery E, in order to avoid this drifting. This is the really critical point in the handling of the outfit. If satisfactory B and E batteries are at hand, many valuable and interesting pieces of work can be carried out with the apparatus described in this article, all of which, excepting probably the galvanometer, is found in the supplies of most radio amateurs. Workers on an outfit of this character should



By-Pass Condensers do a double job. They filter the fluctuating "B" battery current. They provide a free path for the radio frequency currents around the high internal resistance "B" battery.

The first function tends to remove disturbing noises—the second increases efficiency by reducing losses and properly routing the available energy.

The tone quality of every set will be greater in strength—purer—smoother—with a By-Pass Condenser.

External connections for the By-Pass Condenser may be made by connecting it from the minus "B" terminal to the plus "B."

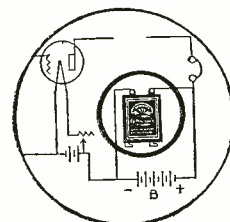

Dubilier

CONDENSER AND RADIO CORPORATION

NEW MODEL C-7 SUPER-HETERODYNE

THE SET THAT MADE RADIO FAMOUS



7 TUBES GIVE THE RESULTS OF 10

The greatest set known for distance, volume and quality of reception. The MODEL C-7 is the result of many years' work by the best-known Radio Engineers, and is made up of the highest quality apparatus available. It is the most sensitive and most selective broadcast receiver that can be built. We distribute only the original E. I. S. parts, and make immediate shipments from stock.

C-7 BLUEPRINT containing all data, etc. \$1.00
 C-10 BLUEPRINTS \$5.00
 "MODERN" RADIO RECEPTION, a real Super-heterodyne Manual. \$3.00

WRITE FOR CATALOG AND PRICE LIST

Radio Parts Co., Labs., 8 S. AUSTIN BLVD., OAK PARK, ILL.

PLIODYNE 6

One of the most selective receivers on the market—Consistent range of 1500-3000 miles. Two stages radio frequency detector, and three stages of balanced audio amplification. Beautiful Fabrikoid-covered Cabinet. Price Without Accessories..... \$60.00

Insure your copy reaching you each month. Subscribe to Radio News—\$2.50 a year. Experimenter Publishing Co., 53 Park Place, N. Y. C.

THE EXPERIMENTER

*The great experimental magazine of Chemistry,
Radio and Electricity*

The EXPERIMENTER combines the fundamentals of these three great industries — and the advances that are made from day to day. Every page gives something new and interesting in experiments from laboratories large and small throughout the world.

Then there is a large, novel radio section entirely devoted to the latest advances in this great field. The EXPERIMENTER keeps you ahead of the industry and in touch with the rapid progress of radio the world over. New hookups, new apparatus and new ideas of every kind are covered. It is the experimental side of radio for the experimenter.

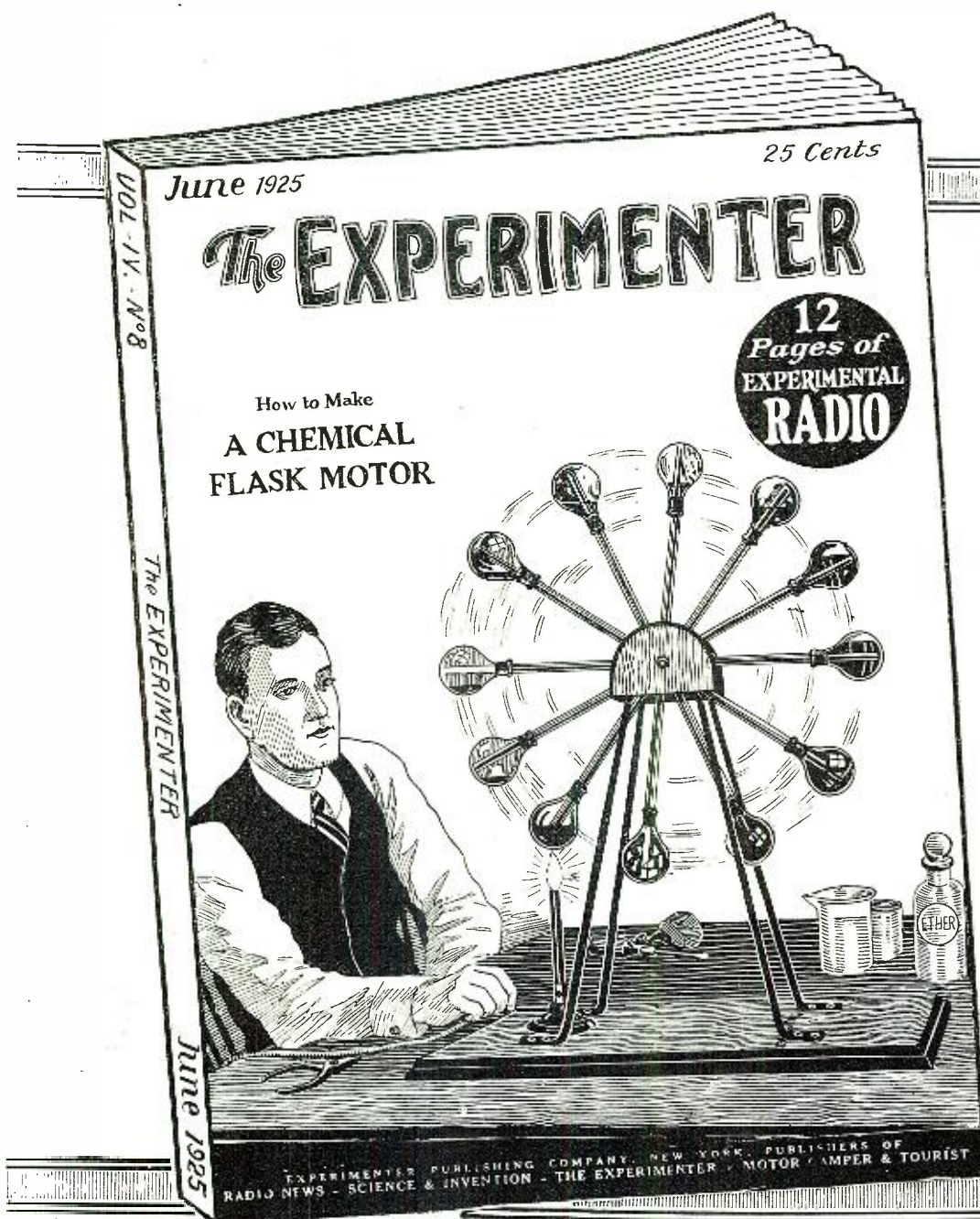

Ask Your
Newsdealer
to Let You
See a Copy
Today!

SOLD ON ALL NEWSSTANDS -25c the copy

Germott Publishing Company, Owners

Licensed Publishers—The Experimenter Pub. Co., Inc. :: :: 53 Park Place, New York, N. Y.

always have before them the possibility of applying it to some new use by which information valuable in a scientific or commercial way may be obtained.

Esperanto Lessons

(Continued from page 43)

STARTING AND ENDING LETTERS

It is not customary to use "kara" (dear) in Esperanto except in letters to relatives or very intimate friends:

S-ro Vilhelmo Mareil,
17, Rue de la Paix, Parizo.

Mia kara Amiko:

More formal forms are:

Mia estimata Sinjoro (Sinjorino, Fraulinino);

Estimata Sinjoro, etc.

Estimata Samideano (-ino). (This is the most commonly used in the general run of Esperanto correspondence, although after long exchange of ideas and a more friendly acquaintance is established, frequently "Estimata" is replaced with "Kara".)

In friendly correspondence the general way of ending the letter is:

Sincere la via, Sincerely yours,

Tutkore la via, Heartily yours,

Kun salutoj, With greetings,

Kun miaj bondeziroj, With my good wishes,

Kun la plej granda estimo, With the greatest esteem,

Via fedela amiko, Your faithful friend,

Sindone via, Amike via, Mi estas via, etc.

In more formal correspondence the conclusion is something as follows:

Tre fidele via,

Tre sincere la via,

Kun al ta estimo la via, etc.

(To be continued)

Radio News—WRNY— Goes On the Air

(Continued from page 35)

frequency meter is installed and connected in such a way that an alarm will be rung immediately if anything occurs. This instrument will read a variation of 10 cycles!

The most complicated single piece of apparatus in the control room is the chief input panel. The reader had best refer, at this point, to the schematic diagram in order to understand all the sources available. Feeding into the panel there are, of course, the microphones of the main studio. There is also a table containing nearly 100 pairs of wires leading into the panel coming from the control room, the main office, the reception room and the hotel public address system.

For distribution at this public address system pick-up is available by microphone from any room of the hotel. By this system an instant's notice to the guests' rooms, dining rooms, lobbies and auditoriums of the hotel makes available for use at the station any addresses, speeches, or other announcements being given anywhere in the hotel. Also coming into this panel there are a pair of leads from the special receiving set, mentioned above, enabling any program being broadcast to be amplified through the panel and re-broadcast through WRNY. Then there are 16 pairs of full metallic phone circuits terminating at the base of the wood

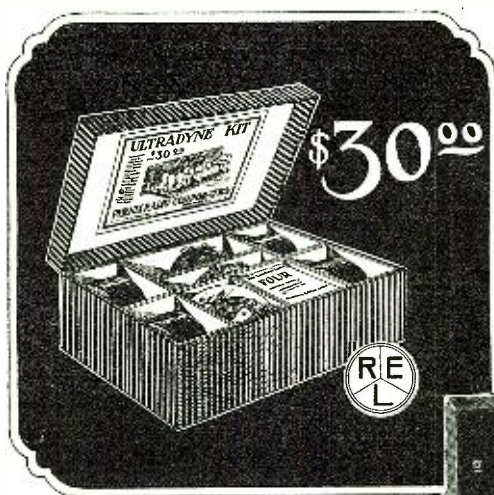

The Genuine
ULTRADYNE
MODEL L-2



Thousands have built it!

THOUSANDS have successfully built the Model L-2 Ultradyne with this Ultradyne Kit and claim it the most wonderful receiver they have ever known. The Ultradyne is the only receiver that incorporates the "Modulation System" of radio reception with its special adaption of regeneration. It is the most famous Super-Heterodyne.

These exclusive features make the Ultradyne the most sensitive set known—capable of detecting the faintest broadcast signals, making them audible on the loud speaker. Also the most selective receiver known—regardless of close similarity in wavelength, the Ultradyne selects any station within range, brings in greater distance, clearly, distinctly, faithfully, on the loud speaker.

The Ultradyne Kit contains all special parts, one low loss tuning coil, one special low-loss coupler, one type "A" Ultraformer, 3 type "B" Ultraformers, 4 matched fixed condensers.

At your dealer's, otherwise send purchase price and you will be supplied postpaid. Complete parts, including cabinet and drilled and engraved panel, \$97.00.

Jobbers and Dealers write for descriptive circular and trade discounts.

Keystone Radio Service, Inc., 120 W. 44 St., New York



THIS COUPON— and 25 cents

How to Build and Operate the **ULTRADYNE** 32 page illustrated book giving the latest authentic information on drilling, wiring, assembling and tuning the Model L-2 Ultradyne Receiver ... **25c**

KEYSTONE RADIO SERVICE, INC.,
120 W. 44th Street, New York.

Gentlemen:

Enclosed find 25c for which please send your Book of Instructions on "How to Build and Operate the Ultradyne Model L-2."

Name

Address

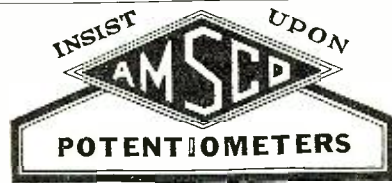

Most Dependable Made

Andrews
Deresnadyne
DE-RES-NADYNE PATENTS PENDING
Radio Receiving Set

ANDREWS RADIO CO.

Tribune Tower

Chicago

U. S. TOOL CONDENSERS

work with a smoothness that prevents skipping by any station. Equally efficient under all conditions.

U. S. TOOL COMPANY, INC.
AMPERE, N. J.

YOU CAN GET

Greater reflex or crystal set reception if you use the

BROWNIE
VERNIER DETECTOR

\$2.00 At your dealer or Direct.

ROLAND BROWNIE & CO.
20 Saunders St. Medford, Mass.

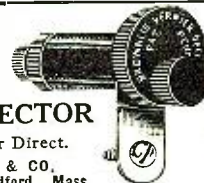

Insure your copy reaching you each month. Subscribe to Radio News—\$2.50 a year. Experimenter Publishing Co., 53 Park Place, N. Y. C.

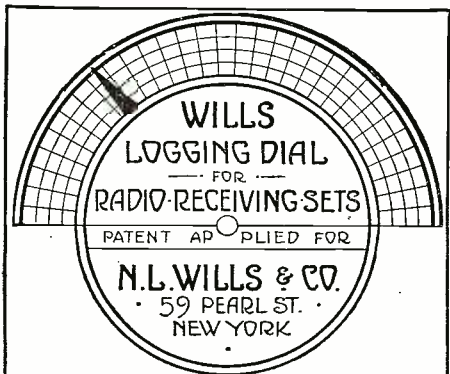

YOU SURELY WILL LIKE THIS

Log your favorite stations in the Handy Vertical Spaces **RIGHT ON THE PANEL**—No Holes—No Tools required. Our system of Interlocking Index Logs permits logging of unlimited stations. The Little Red Arrow always finds them right on the dot. Can be attached in two minutes. Made for 3 and 4 inch dials. 50c a set in Velour Cardboard; 75c in Celluloid.

ROICE RADIO TUBES

The Royalty of Radio Tubes
A powerful and durable tube that will greatly improve reception increase range and volume with a maximum of clearness. Our direct sales plan enables you to buy "Roice" at the lowest possible price.

Type 00 5 Volts, 1 Ampere Detector Tube.
Type 01A 5 Volts, .25 Ampere Amplifier and Detector.
Type 99 3/4 Volts, .06 Ampere Amplifier and Detector.
Type 99A 3/4 Volts, .06 Ampere With Standard Base Amplifier and Detector.
Type 012 1 1/2 Volts, .25 Ampere Platinum Filament Amplifier and Detector. **\$2.00**

ALL TYPES \$2.00
Type 02, 5 Watt Transmitter \$3



Shipped Parcel Post C. O. D.

EVERY TUBE GUARANTEED to work in Radio Frequency. Especially adapted for Neurodyne, Reflex and Super-Heterodyne Sets. When Ordering Mention Type
ROICE TUBE CO., 21 Norwood St., Dept. N, Newark, N.J.

which may, with the aid of the jumpers, be thrown into the supply for amplification, enabling pick-up to be made anywhere within radius of the land lines of the American Telephone and Telegraph Company.

MONITORS

Also from the speech input panel, the monitors lead out to the control room, the offices, the receiving room, the main studio, to a special monitor in the engine-room in the basement, and thence to a connection arrangement whereby the monitor output may be thrown out to the telephone lines mentioned, so that other stations may broadcast the same program, if necessary. Also there are leads from the monitor control to the hotel public address system on the first floor of the hotel, so that any programs being given by WRNY may be made available to the guests of the hotel through loud speakers which are attached to the public address system.

These points are all clearly shown in the schematic wiring diagram. This last arrangement, by which the radio station may pick up anything in the hotel or pass out its programs through loud speakers to all of the public rooms in the hotel, is a decided innovation. Of course, the wiring had all to be very carefully done and the installation made with repeaters and retardation coils and other electrical apparatus for balancing the output so that the induction noises and other line interferences would not be noticeable in the loud speaker output. Through this public address system every room in the hotel also becomes a studio.

Of special interest is the method of supervising the station's operation in the station itself. There is an order wire giving code connection in each of the rooms and departments. There is also monitoring connections to each of the departments, so that every man connected with the station has, at all times, knowledge of the output, and instant means of communication to all other departments.

ANNOUNCER'S DELIGHT

From the appearance of the diagram one might think that the station would be extremely complicated and would need scores of men to keep it in operation. However, quite the contrary is the case. All complications possible have been cut out and control has been reduced to the very simplest arrangement. One illustration of this is shown in an accompanying photograph, which pictures the control box on the wall of the main studio. The small light at the left flashes as soon as the power supply goes on the panel. The small light on the opposite side lights the instant the carrier wave is emitted and the red light at the top tells the instant broadcasting begins. By a cord and hand snap-switch connected at the bottom of the box, the announcer has absolute control of the microphone at all times. He may walk about the studio with the aid of a flexible cord and be absolutely in charge of his output.

As soon as the carrier wave starts, an automatic device modulates it; at all times when a number is not being broadcast, this characteristic note, similar to that of a cuckoo, will go on the air so that listeners will be able to tune in the station as well between as during numbers. Also, this gives a method of identification which will assist the DX hunters who cannot hear the actual announcements being made.

Aside from technical innovations, the program policy of the station will be very different from anything now on the air. There will be broadcast, for instance, radio hook-ups by a brand new system invented by Mr. H. Gernsback, editor of RADIO NEWS. The system is fully explained in this issue. A complete 1-tube radio hook-up can be broadcast in 4 minutes; a 7-tube super-heterodyne in about 8 minutes. The station

How To Locate Troubles In Your Radio Set

Locating troubles in your radio set, especially the super radio sets that are being built today, presents quite a problem. There are several troubles common to radio receiving sets, such as, incorrect wiring, or wiring that is short circuited, poor connections, wrong battery leads, etc.

BOOK No. 12

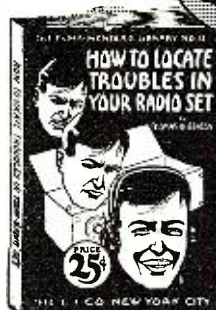

How to Locate Troubles In Your Radio Receiver

The E. I. Company Book No. 12 tells you how to locate these troubles. It shows you how to test the batteries to see if the leads are correct, how to check the circuits of the receiver, and such explanations as will enable you to rectify practically any trouble.

This book contains sixty-four pages of information of this kind. It is one radio book that you should have on hand at all times. It may save you the price of five or six tubes, it may save you the price of a set of batteries, or it may mean the difference between good reception and poor reception.

This book is profusely illustrated with pictures, charts, and diagrams. It is written in plain English so that you can fully understand every word of it, bound with extra heavy cardboard cover, printed in two colors, size 5 x 8 in.

PREPARE FOR ANY EMERGENCY BY OBTAINING A COPY OF THIS BOOK TODAY.

PRICE 25c—POSTAGE PAID

E.I. Company

SOLD BY ALL RADIO AND NEWS DEALERS

Sole Distributors

The Conrad Company, Inc.
233 Fulton Street New York, N. Y.

FAHNESTOCK CLIPS

The Perfect Radio Connectors—Are Used



By manufacturers of standard sets and parts and makers of wet Battery and exclusive on Eveready Dry Batteries. Their Sure Patented Grip is recognized universally by enthusiastic users.

Reg. U.S. Patent Office

FAHNESTOCK ELECTRIC COMPANY
Long Island City

Go Into Business for Yourself! Be Your Own Boss!

Free Book Tells How

Send today for our Kit Catalog. 36 pages, 7x10. Contains bargain offers of best 38 radio receiver kits. Explains how to make money building sets for friends and neighbors. You can do it! Write for Book Now.

RADIO SPECIALTY COMPANY
Kit Div. 679E, 245 Greenwich St., New York

The SATURN
Perfect Jack and Automatic Plug. Your order filled by mail promptly. Every article absolutely guaranteed.

The SATURN Mfg. & Sales Co., Inc.
48 Beekman St. New York, N. Y.
Dept. R.N.
Write for Literature

Slight Touch Releases the Tip

has truly been described as the magazine of the air. About 50 per cent. of the operation time will be given over to the usual entertainment numbers, such as musical selections, addresses, market reports, etc., while the other half will be used for the dissemination of scientific and feature information. RADIO NEWS feels that it is in a position to obtain the best in the scientific field for its listeners.

From time to time, further announcements of these plans will be made, and RADIO NEWS feels that it is not overstepping truth in the slightest to say that taken day for day, the programs of WRNY will be fully as interesting as those of any other station now in operation in the country.

Remember that just as RADIO NEWS is different from all other radio magazines so WRNY will be different from all other broadcast stations!

The slogan of the new station will be: 'WRNY—THE NOVELTY STATION'

Reactance

(Continued from page 67)

thermore, the higher the inductance, the steeper the slope of the line, indicating that the reactance increases with the frequency more rapidly for the higher inductance than for the lower.

In Fig. 6 are given three curves which have been plotted to show how the capacitive reactance varies with the frequency for three different values of capacity, viz.: 0.001, 0.0005, 0.00025 microfarad. These curves have the shape of a hyperbola, which is the usual shape for a curve of reciprocals—that is, when the variable quantity (in this case, the frequency, f) is in the denominator of the fraction. It is easily seen in the formula that when the frequency f increases, the capacitive reactance decreases, and *vice versa*. This is plainly shown in the curves. As we go toward the right (increasing frequency) the curve rises, indicating that the capacitive reactance becomes less and less. The curves have been plotted below the horizontal axis, since the capacitive reactance is regarded as negative.

When the frequency is zero (direct current), the reactance is infinite, as indicated by the fact that the curves go off the chart at the low frequencies. As the frequency becomes very great, the reactance gradually approaches zero, as indicated by the curves approaching the horizontal axis at the upper right-hand corner. The greater the capacity, the less the reactance and the more abrupt the bend in the curve.

When there is both inductive and capacitive reactance in series in an alternating current circuit, the two expressions given above are simply added geometrically, that is, keeping the positive and negative signs as indicated. To show the effect graphically, the two curves representing the two reactances may also be added, as shown in Fig. 7. The resulting expression is:

$$X_t = 0.00628 fL - \frac{159.3}{fc}$$

in which X_t is the total or net reactance in ohms. The curve in Fig. 5 for the inductive reactance of a coil of 100 microhenries, and the curve in Fig. 6 for the capacitive reactance of a condenser of 0.001 microfarad have been re-plotted in Fig. 7 on a smaller scale. These are the solid curves in Fig. 7. These two curves were added by a scale or pair of dividers, producing the broken curve, which represents the net reactance in the circuit.

It will be noted that there is one point where the two reactances annul each other,

The Secret of a Real Portable is to Build it in a—

Karryadio Case

TRADE MARK

Pivoting Loop Forming Cover

Collapsible Horn Folding in Case

Takes Standard Panel

The greatest value ever offered portable set builders. The three essential portable requisites for the price of one

PIVOTING LOOP-COVER—the cover contains a low loss loop with center tap and is so designed that it can be turned in any direction—to pick up different stations.

COLLAPSIBLE HORN—when closed it occupies only a space an inch thick and can rest on top of batteries—opened it measures six inches square, giving wonderful volume and tone.

COMPACT DESIGN—the conservation of space is the first essential in building your portable—Karryadio is the final word in compactness—yet great care was taken to allow ample room for every need of a radio set. The sturdy black leatherette case measures 18 $\frac{3}{8}$ inches long, 4 $\frac{1}{4}$ inches wide and 5 $\frac{1}{2}$ inches thick—no larger than a week end case.

All radio set builders agree that the loop, horn and the case are the three hardest problems encountered in building a portable—Karryadio supplies the three all in one, at low cost.

Enjoy your radio this summer. All you need to do is to build your set on a standard panel—set it in the Karryadio and your portable is complete.

WRITE TODAY

ARMLEY RADIO CORPORATION, 68-70 Fleet Street, Jersey City, N. J.

At Your Dealer's or Mail Coupon Below.

PRICE \$15

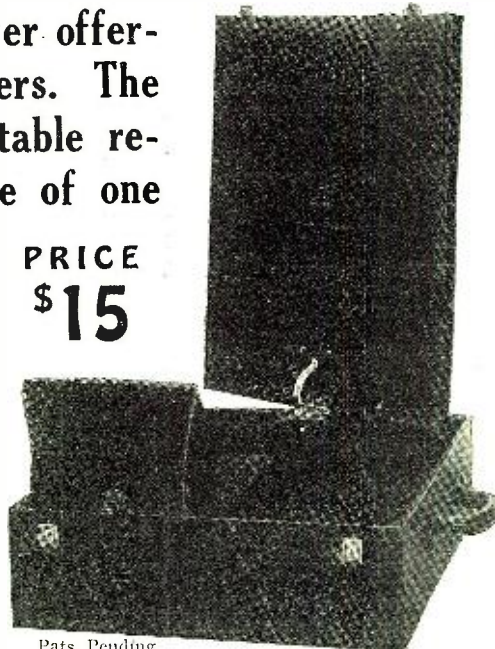

Pats. Pending

ARMLEY RADIO CORPORATION, 68-70 Fleet Street, Jersey City, N. J.

Gentlemen:—I am enclosing \$15.00 for which send me without further charges one "Karryadio Case" with pivoting loop-cover and collapsible horn

Name City

Address State

My Dealer's Name is

Address

ON THE OCEAN FRONT

CAPACITY 1000

The Breakers

Atlantic City, N. J.

American or European Plan

Sea Water in All Baths

ORCHESTRA

AFTERNOON TEAS

THERAPEUTIC BATHS

DANCING

GOLF PRIVILEGES

FIRE-PROOF GARAGE

JOEL HILLMAN, President

HUDSON-ROSS

Sells only nationally advertised radio apparatus.

Send for discounts.

123 W. Madison St. Chicago



Largest Selling Transformers in the World

Consrad's Greatest Book

Table of Contents

- Information for the Broadcast Listener.
- Radio Broadcast Stations of the U. S., by Call Letters.
- Radio Broadcast Stations of the U. S., by States.
- Radio Broadcast Stations of Canada, by Call Letters.
- Foreign Radio Broadcast Stations, by Countries.
- Special Land and Experimental Radio Stations of the U. S.
- Table for Making Time Transitions.
- Time in All Parts of the World.
- Time Signals.
- Weather, Hydrographic, and Market Reports.
- American Radio Relay League and Directory.
- Amateur Radio Stations of the U. S., by Districts.
- Radio Maps of the U. S., North and South America, Canada, Europe, Asia, Africa and Australia.

114 Large Pages of Real, Practical Information—
No Advertising

Size 9 by 12 inches.
Contains 114 pages.

Bound with Beautiful
Stiff T w o - C o l o r
Cover.

Published Twice a Year.

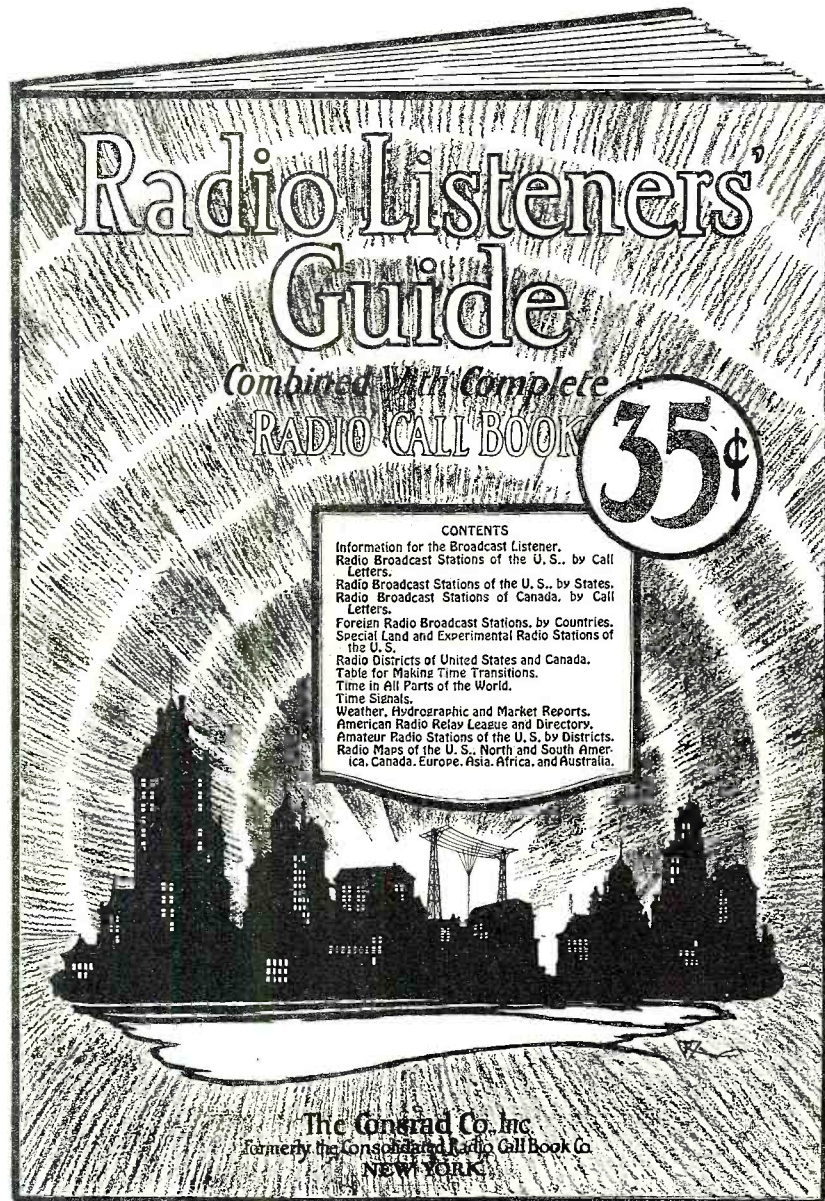

1925 Edition Large Magazine Size

Radio's Finest and Most Complete Call Book

There has never been any radio book for the amateur, the engineer or the regular radio broadcast listener exactly like this great Consrad edition.

Here is a book for *everybody*, covering all the information any listener needs to most thoroughly enjoy a radio program. It tells how to use and operate a radio set to the best advantage. It tells where, by whom, and on what wave-length every radio broadcast station of the United States is operated, etc.

Altogether there are 114 pages filled to the brim with practical data. There is not a page of advertising—all text material for the user.

This is the one radio book that should be at the side of every radio receiving set in operation.

ASK YOUR RADIO OR NEWS DEALER OR WRITE TO US DIRECT

THE CONSRAD COMPANY, Inc., 233 Fulton St., New York, N. Y.

Consrad

and the broken curve of net reactance passes through zero. This is at the *resonant frequency* of the circuit, which is therefore defined as *that frequency at which the reactance becomes zero*. Since the reactance is zero at this frequency, in this case, about 500 kilocycles (or 600 meters), it follows that the current which flows in the circuit under any given, impressed voltage will be a maximum. This is the principle of tuning radio circuits. The capacity or inductance in the circuit is adjusted until the reactance becomes zero. There is a certain relation required between the capacity and inductance to obtain zero reactance; this is that their product must have a certain value for any given frequency.

To obtain the conditions for resonance all that we have to do is to take the equation for X_t given above, put it equal to zero, for the reactance must be zero, and solve for the frequency f . When this is done we will obtain the expression

$$f = \frac{159.3}{\sqrt{LC}}$$

which enables us to calculate the resonant frequency of a series circuit when we know the inductance and capacity in it. As before, f is in *kilocycles*, L is in *microhenries*, and C is in *microfarads*. This may easily be converted into the form

$$\lambda = 1884 \sqrt{LC}$$

where λ is the wave-length in meters, from the relation $\lambda = 300,000/f$.

In this formula it can be seen that for any given frequency or wave-length, the product LC of the inductance and capacity must have one certain value. There are many combinations of L and C , however, which can give the required product, called the *oscillation constant*. We may use a large inductance and a small capacity, or *vice versa*. The only requirement is that their product must have a certain value for each frequency required.

The next important idea for the student to fix firmly in his mind is that of *impedance*. The alternating voltage impressed on a circuit has to send the current against two things opposing it, *viz.*: the reactance and the resistance. Without going into the theory of how the reactance is combined with the resistance to get the total impedance in the circuit, it may merely be stated that the relation between these three quantities is the same as the relation between the three sides of a right triangle.

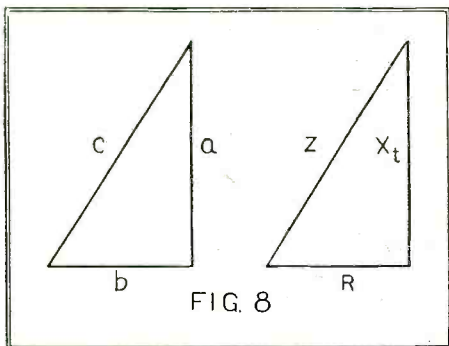

FIG. 8

The ordinary laws of the triangle apply to radio circuits.

Such a right triangle is shown in Fig. 8, in which the altitude and base are a and b , respectively. The hypotenuse of the triangle, c , is obtained by the well-known formula:

$$C = \sqrt{a^2 + b^2}$$

The identical relation between the three electrical quantities is shown in the other right triangle in Fig. 8, in which the altitude X_t is the total or net reactance in *ohms*, the base R is the resistance in *ohms*, and the hypotenuse Z is the impedance in *ohms*.

This Catalog is for YOU

Explains what you want to know

About new revolutionary way of assembling your radio set from one of our kits—no solder, no bus bar, no poor connections, no waste of time, no skill required, no dissatisfaction, no tools needed except common screwdriver and pliers. Even a boy can quickly assemble a complicated kit.

SEND Today!

"No-Sod-er"

MAKES SET-BUILDING EASY
(Trade Mark Reg. U. S. Pat. Off.)

All connections are made by the use of our flexible, insulated eyeleted connecting wire in place of bus bar or wire, and solder. And in a fraction of the time usually required when using the old fashioned way. And when the job is done it is neat and your connections are tight. Makes set-building a pleasure.



This Free Book Tells

—HOW TO ASSEMBLE YOUR OWN SET without the bus-bar-and-solder nuisance. —HOW TO GET YOUR OWN KIT and Accessories without Charge. —HOW TO GO INTO BUSINESS for Yourself and Make Money Building Sets for your Friends and Neighbors.

Book contains 36 pages
7x10 inches

packed full of the most useful and interesting matter ever put into a radio catalog.

You Need This Book!

Tells about the Marvels of Radio—How it Helps All and Brightens Every Home—Gives List of Broadcasting Stations—Specimen Programs—And How Programs are Made Up—Answers the Questions. "What Set Shall I Buy," and How Much to Pay—Describes "No-Sod-er" Wiring System—Explains How to Get Your Own Radio Outfit Without Money—How to Save \$65.00 in Five Hours—How to Make Money by Going into Business for Yourself and Building Sets for Others—Tells Where Orders are Awaiting You—Where and How You Can Transact Your Business—Contains Detailed Descriptions and Finest Illustration of Large Number of Best Kits in Existence and Quotes Lowest Prices—Lists Full Line of Radio Parts and Accessories—Explains Our Fair, Easy, Liberal, Golden-Rule Plan of Doing Business. You Need It.

GOODS SENT ON APPROVAL—
NO MONEY IN ADVANCE—
QUICK SHIPMENT—
WE PAY TRANSPORTATION—
Satisfaction or Money Back
SEE BIG AD., PAGE 12

Radio Specialty Co.
Div. 679D, 245 Greenwich St., N. Y. City

MAIL THIS COUPON NOW

RADIO SPECIALTY COMPANY,
Kit Div. 679D, 245 Greenwich St., New York
You may send me your Kit Catalog No. 14
if without charge or obligation.

Name.....
Street.....
P. O.State.....

100 Volt Storage "B" Battery for \$10.00!



Everybody can now enjoy the benefits of Storage "B" Batteries—more power, quieter reception, greater economy. Rubber case prevents leakage or shorting. Easy to recharge. Will last for years with ordinary care.

SERVICE Rechargeable "B" Batteries
—in all-rubber cases
100 VOLTS \$10.00
50 VOLT—\$5.50
125 VOLT—\$12.50

SERVICE BATTERY CO.
704 East 102nd Street Cleveland, Ohio

SERVICE Double-Duty CHARGER



Charges 6-volt "A" or Auto Batteries or up to 125 volts of "B" Battery IN SERIES. Noiseless in operation. Extremely economical. The height of convenience.

Complete with Bulb \$14.50

Prices in Canada

50 VOLT \$7.75 100 VOLT \$14.50 125 VOLT \$17.00

SERVICE BATTERY CO. of Canada, 137 Roncesvalles Ave. Toronto, Ontario

Insure your copy reaching you each month. Subscribe to Radio News—\$2.50 a year. Experimenter Publishing Co., 53 Park Place, N. Y. C.

FREE!
12-Cell — 24-Volt Storage 'B' Battery

Positively given free with each purchase of a WORLD "A" Storage Battery. You must send this ad with your order. WORLD Batteries are famous for their guaranteed quality and service. Backed by years of successful manufacture and thousands of satisfied users. Equipped with Solid Rubber Case, an insurance against acid and leakage. You save 50 per cent and get a

2-Year Guarantee Bond in Writing

WORLD BATTERY COMPANY
 1219 So. Wabash Ave., Dept. 10 CHICAGO, ILL.

World STORAGE BATTERIES

Approved and Listed as Standard by Leading Authorities including Radio News Laboratories, Popular Science Institute of Standards, Popular Radio Laboratories, Radio Broadcast Laboratories, In the Home and Lefax, Inc.

6-Volt, 100-Amperes	\$11.25
6-Volt, 120-Amperes	13.25
6-Volt, 140-Amperes	14.00
6-Volt, 11-Plate	\$11.25
6-Volt, 13-Plate	13.25
12-Volt, 7-Plate	16.00

Send No Money. Just state battery wanted and we will ship day order is received, by Express C. O. D. subject to your examination on arrival. **FREE** "B" Battery included. Extra Offer: 5 per cent discount for cash on full order. Buy now and get a guaranteed battery at 50 per cent saving to you.

For AUTO and RADIO

WORLD BATTERY COMPANY
 1219 So. Wabash Ave., Dept. 10 CHICAGO, ILL.

WORLD BATTERY COMPANY
 1219 So. Wabash Ave., Dept. 10 CHICAGO, ILL.

The impedance may then be computed from this triangle, viz.:

$$Z = \sqrt{Xt^2 + R^2}$$

or, if we wish, we may insert instead of Xt, its algebraic expression given above. This formula shows what happens when the reactance of the circuit is made zero. When Xt is zero in the above formula, we have simply $Z = R$; the only opposition to the flow of current is the circuit resistance. If we should want to go to the trouble to do it, we could add this resistance to the chart of Fig. 7. It would be represented by a straight, horizontal line at a distance above the axis of frequency equal to the resistance. From this line and the curve of net reactance we could calculate, point for point, the impedance curve. This would be slightly higher than the net reactance curve at every point, and, as a consequence, the resonant frequency would be slightly lower than the chart indicates. In the usual low resistance tuned circuits used in radio apparatus, the difference would not, ordinarily, be noticeable.

The reactance diagram described above is a very valuable means for studying and designing radio circuits. In articles to follow this method will be used to analyze coupled circuits. It is safe to say that it is a very difficult matter to clearly explain or understand coupled circuits without the use of the reactance diagrams. In the next issue, the parallel circuit will be studied by this means, and the difference between the operation of the series circuit and the parallel circuit will be clearly brought out.



The DAVEN
 RESISTANCE COUPLED
 AMPLIFIER KIT

The Aim of Radio is distortion-less reproduction—the

DAVEN RESISTANCE COUPLED AMPLIFIER

hits the mark! Three or four stage kits bring its perfection to those "who build their own."

Buy from your Dealer the "RESISTOR MANUAL" our complete handbook on Resistance Coupled Amplification. Price 25c, Post Paid 35c.

DAVEN RADIO CORP.
 "Resistor Specialists"
 Newark, N. J. New Jersey

free

Send for it Today!

for Good Reception

Pacent RADIO ESSENTIALS

Radio builders—both amateur and professional—will find this interesting book helpful in choosing the best parts for their sets. Over forty leading radio manufacturers now using Pacent Essentials as standard equipment.

PACENT ELECTRIC CO., Inc.
 91 Seventh Ave., New York
 Minneapolis Birmingham San Francisco Washington
 Philadelphia Jacksonville St. Louis Buffalo Detroit
 Boston Chicago
 Canadian Licensees:
 R. H. White Radio Co., Hamilton, Ont.

Pacent RADIO ESSENTIALS

DONT IMPROVISE — PACENTIZE

Spaulding
 -BAKELITE
 RADIO PANELS
 SPAULDING FIBRE COMPANY INC.
 TONAWANDA, N.Y.

NOTICE TO MANUFACTURERS — GEORGE FIELD
 Wireless Supplier, Newcastle, New South Wales, Australia.
 Above being largest RADIO factor of Newcastle, Hamilton, Maitland and Cessnock district, invites manufacturers to submit samples which will be purchased or returned. (No Sets, Speakers, or articles of bulk.)

Correspondence From Readers
 (Continued from page 72)

and reconstruct this receiver, when all components will be mounted inside the cabinet and so arranged that a minimum of wire will be used for connecting.

By means of plug-in arrangements for R.F. transformers the wave-length range of the reconstructed receiver will be from 50 meters (and possibly less) to about 1,000 meters.

Three sets of R.F. transformers have already been designed to work with square law condensers of .0002-mfd. capacity, whilst three separate reaction variometers will also be used, wound and arranged so that a few turns may be closely coupled to the aerial transformer secondary.

Perhaps I ought to say that I am situated in open country, unshielded and at a natural altitude of 600 feet above sea level, my aerial being a single length of 7/22 stranded and enamelled copper wire, 40 feet high at mast, 75 feet long and 25 feet high at lead-in end. It is well insulated and the receiver is practically below the lead-in, the earth lead being only about 7 feet long.

I am not yet fully licensed for transmission, but hope to be so in the very near future.

With all good wishes for the continued success of your excellent publication and also to 3 BID for his very interesting articles, I am,

JOSEPH WM. NELSON,
 15 Maxwellton,
 East Kilbride,
 Glasgow, England.

CHOKER HIM

Fred: "Why this talk about radio being the 35th national industry?"

Ned: "I can't say. I supposed it to be the 'lead-in' industry."

Contributed by Jack Bront.



THOUSANDS

of customers have been pleased with our goods. We have been making Radio Furniture for 37 years.

Send for Free Catalogue

The Southern Toy Company
 Dept. N. HICKORY, N. C.



At your dealer **\$1.00**

You can put your set in that convenient corner and

LIGHT UP
 your radio panel with the new

WALBERT PANELITE

WALBERT MFG. CO., CHICAGO

Insure your copy reaching you each month. Subscribe to RADIO NEWS—\$2.50 a year. Experimenter Publishing Co., 53 Park Place, New York City.

The Inventions of Reginald A. Fessenden

(Continued from page 21)

in the *Boston Transcript* of April 6, 1925. After describing the specific equipment, which has cost the taxpayers of the U. S. many millions of dollars, he says: "Our laboratory facilities are unusually complete. We have a research associate plan. Under this arrangement an industrial group can send to this department a representative to work on some particular problem of interest to that industry. His salary" (alone) "is paid by his employers, but in other respects his status is that of a member of the department's research staff. He has the use of the laboratories and the benefit of the experience of our people" (i. e., they assist him without pay). "The results of his work are published by the bureau after approval by those interested."

The exact number of publications approved by the new form of trusts may be judged by the fact, disclosed in *Nature*, issue of February 7, 1925, that of 29 such reports of research work done almost entirely at government expense, and in a government bureau, not a single one has been published; every one is the secret information of the members of the trust. The total number of scientific publications for the past year available to the manufacturer outside of the trust, or to the inventor, or to the independent scientist, from the department referred to, with its millions of dollars of equipment and its large annual appropriations, was just nine and those of minor importance. But the independent manufacturer and the inventor and the independent scientist paid their share of the cost of these trust and Cabiri secrets.

It will readily be understood that the manufacturer who desires to be independent is virtually back-jacked into the trust, at government expense, and that the patent office is virtually eliminated.

3. If an invention is made in any industry, say in the piano manufacturers, and is submitted by an inventor to any one member of the industry, that manufacturer cannot adopt it. It has first to go before the branch of the Research Council which controls that industry. If the Research Council can see no way of eliminating the individual inventor in that particular case, the reply goes back, through the association to the particular manufacturer and thence to the inventor, that the manufacturer has decided not to adopt the invention. And if the inventor goes to any other piano manufacturer, no matter where, in the United States, he will find that they each and all know of the invention but are each and all decided not to adopt it. If any manufacturer did adopt it he would be put out of business by the Research Council in short order. If, however, the Research Council believes that the patent is loosely drawn and can be evaded, the council puts its own men to work to do so.

The immediate net result is of course elimination of the independent manufacturer and independent inventor; then stoppage of all improvement in the art, for as shown in a previous section corporations never invent or adopt any improvement of importance unless forced to by outside competition; then a hectic prosperity; then stagnation in the industry and high prices to the consumer, and finally hard times.

The Research Council thus controls absolutely every industry and every manufacturer in the United States, except a few, like Ford and Edison, who are able to hold out.

4. The present plans of the Research Council call, it is understood on good authority, for the placing of all stock of trusts so far as is possible in the hands of small

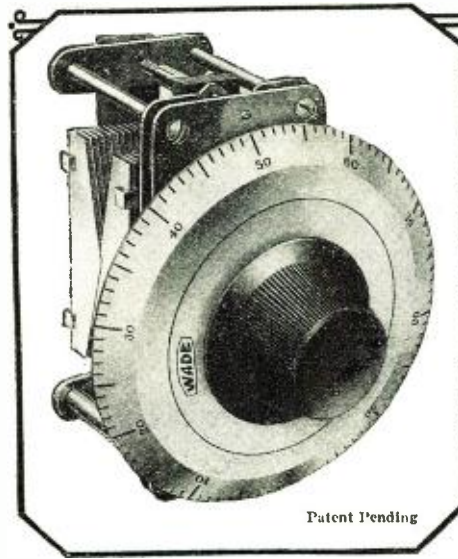

Patent Pending



Easy as picking 'em off a map!

Wade Square Law Condenser and Dial

All sizes, complete with 4-inch vernier dial, for:

- Short wave .000125 mfd. \$7.50
- Tuned Radio Frequency, .00025 mfd.. \$7.75
- Super-Heterodynes, .0005 mfd. \$8.00

At your dealers, otherwise send purchase price and you will be supplied postpaid.



Tuning is easy now! Special plate construction spreads stations over the dial. Makes it possible to locate any station instantly. Wade Condensers are furnished complete with four inch 360 degree vernier dial—give more space between stations for close tuning adjustment.

The special design completely insulating the shaft from the plates and the separately grounded frame eliminate all body capacity—even in the most sensitive sets. Wade is the only condenser so constructed and is a revelation in fine tuning.

Built upon advanced scientific principles in every detail to increase tuning and operating efficiency.

Write for descriptive folder.

WADE MANUFACTURING COMPANY, Inc.

1819-A Broadway

New York



TRADE-MARK

REGISTERED

LEARN RADIO

Become a big-pay man in the greatest industry of all time. Quickly, easily and right at home, you can fit yourself for highest salary positions, or you can cash in on your spare time. The call is urgent for mechanics, operators, designers, inspectors. Unlimited, fascinating opportunities on land or sea.

I WILL TRAIN YOU AT HOME TO BE A RADIO EXPERT

Under my practical, easy to understand, instruction—you qualify in an amazingly short time. No previous experience is necessary. Every branch of radio becomes an open book to you. You learn how to design, construct, operate, repair, maintain and sell all forms of Radio apparatus. My methods are the latest and most modern in existence.

FREE Wonderful home construction tube receiving set of the latest design. **Write Today** "Radio Facts" **FREE**

A. G. Mohaupt, Radio Engineer, RADIO ASSOCIATION OF AMERICA, Dept. 157, 4513 Ravenswood Ave., Chicago



TWO SIZES

No. 4524—3½ amp. hr.—24 volt

No. 4548—4½ amp. hr.—48 volt

STORAD RELIABLE BATTERIES

We stake our reputation as Storage Battery and Radio Engineers on these batteries because they are built to give reliable service on modern multitube sets.

You can solve your "B" circuit power problem with Storads.

Ask your dealer or write direct for information.

Distributors' territory is still available.

The Cleveland Engineering Laboratories Co., 2120 Superior Viaduct, N. W., Cleveland, Ohio

\$100 Per Week

easily made in your spare time selling one of the best and fastest selling radio sets on the market today—no experience necessary. No manufacturing; you sell a complete outfit. Send me a card and I will send you complete information.

DAVE RIKER, Salesmanager
88 West Broadway New York

LOW LOSS TUN-A-FAR

THE NEW RADIO SENSATION GETS WONDERFUL DISTANCE Marvelous Selectivity, Beautiful Tone and Tremendous Volume

B-ELIMINATOR KIT
Price \$20.00

FREE Diagram for One Knob Hook-up with Each Coil.
A. H. WAAGE 6 Reade St., New York, N. Y.



Insure your copy reaching you each month. Subscribe to Radio News—\$2.50 a year. Experimenter Publishing Co., 53 Park Place, N. Y. C.

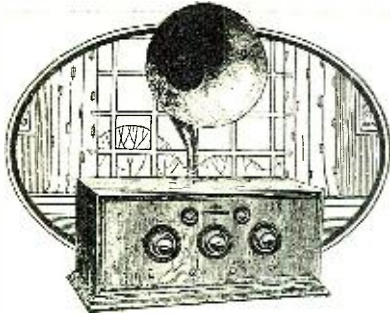

Hear the Murdock Neutrodyne

COMPARE the Murdock Five Tube Neutrodyne for the quality of its tone; for the beauty of its cabinet; and for its reasonable \$100. price!

There is space in the cabinet for the "B" batteries. The only accessories necessary are batteries and tubes. A "Murdock" set is backed by twenty years of successful experience in making radio apparatus.

\$100.
with built-in
Loudspeaker
\$92.50
without

WM. J. MURDOCK CO.
Dept. A5, Washington Ave.
Chelsea, Mass.

MURDOCK NEUTRODYNE



shareholders, and placing members of the Research Cabiri on the boards in influential positions.

5. On the Universities, the first hold of the Research Cabiri is through the Carnegie and other pension funds. No professor who opposes the Cabiri can hope for any support for his declining years. It will be remembered that his pension was arbitrarily denied to Wilson, though he was strictly entitled to it.

The second hold is through endowment shares in industrial corporations controlled by the Research Cabiri. In a recent case this has gone even further, and one of the great universities, endowed with millions of dollars by independent donors, is now an actual partner in one of the trusts, and cannot sell the stock, but must depend on the trust being profitable.

A third is through control of positions for the university graduates. A student who enters one of the universities (with the exception of a very few who still hold out) has parted with his liberty for life. No matter how brilliant his class record, he cannot obtain a position unless he satisfies the Cabiri and the trust which controls his chosen field of work, and he cannot engage in business as an independent manufacturer, as shown above. Nor can he become a consulting engineer, for all that work is now turned over by the Research Council to its own universities, where the students are detailed to the work for little or nothing, and the professors must take charge of the work for nothing or lose their positions. To all intents and purposes the student is therefore a slave to the Research Corporation as much as any negro was to the plantation owner.

DEFENCES OF THE INDEPENDENT INVENTOR AGAINST THE RESEARCH CABIRI

Some of these are already in existence; others should be created.

1. *The Patent Office.* This institution, on which the wealth of the United States is founded is an obstacle in the way of the Research Council which has already, by the "confidential research report" system outlined above, neutralized the chief function of the Patent Office which its founders intended it to fulfill. It has also (but much less than might have been expected, to the honor of the men, be it said) had a bad effect on the morale of the Patent Office employees, necessarily, for with the elimination of the individual inventor there is no longer any future or opening for a Patent Office official except with one of the trusts. And soon there will be none at all, for obviously when the combines are completed by the Research Council and the results of all researches are preserved in confidential reports, there will be no object in the trusts taking out any patents, and we will have returned to the medieval system of "trade secrets" which, it was found, proved so detrimental to civilization, and from which the Patent Office was created to free us.

Efforts will naturally be made by the Research Council to block the purposed functioning of the Patent Office; are, in fact, now being planned, it is understood. All new legislation must be carefully watched.

2. *The Courts.* We still have the Courts. That they are a real defence is shown by the complete failure of the recent attempts of the Research Council to seize Roger's under-water wireless and DeForest's regenerator. No doubt courts are occasionally fallible, as is every human institution, but they are a stronghold of civilization.

3. *Elimination of Secret Reports of Work, Any Part of Which Is At the Expense of the Taxpayer.* The publication, immediately on completion of all work, conducted in part or wholly at government expense, should be called for by law. This would give the independent manufacturer and taxpayer a chance.

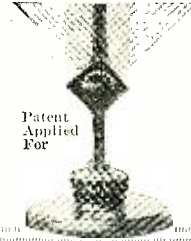

KORACH TUNED LOOP

Tuning Feature
Directional
Can Be Logged
Collapsible

The Loop COCKADAY used on his famous 8-Tube Super Reflex to bring in 2LO, London; 2BD, Aberdeen, Scotland; 5NO, Newcastle, Eng.; 2PY, Plymouth, Eng.; ESP, Paris, France; PTT, Madrid, Spain; WKA2, Porto Rico, and other over-seas stations. Approved and recommended for the COCKADAY Superheterodyne and all other sets designed for loop reception. Exclusive features give you selectivity and distance unheard of before with loop aeriels. If your Dealer cannot supply you, order direct from us. Price \$16.50. Send \$2.00 as good faith deposit with your order, balance C.O.D. Express. Satisfaction guaranteed.

KORACH RADIO CO.

309 So. LaSalle Street
Dept. 7, Chicago, Ill.

Full Particulars on Request.

DEALERS AND JOBBERS: Write at once for attractive proposition.

Batteries furnish fuel to your set.
Give your set the best.

Radio **DIAMOND** "B"

BATTERIES

DIAMOND ELECTRIC SPECIALTIES CORP.

103 South Orange Avenue, Newark, N. J.
Dealers, Jobbers—Write for Proposition

REBUILT
at 1/2 cost
of new
tubes

**SAVE HALF
THE COST OF
NEW TUBES**

BY HAVING YOUR
OLD BURNED OUT
AND BROKEN TUBES
REBUILT

Guaranteed equal to new.
Send us your tubes by
parcel post. We return
them parcel post, C. O. D.
and try to maintain 24
hour service.

HARVARD RADIO
LABORATORIES
200 Old Colony Avenue
South Boston, Mass.

**AUTO RUNS
57 MILES ON
GAL. of "GAS"**

A new automatic and self-regulating device has been invented by John A. Stransky, 492 Fourth st., Pukwana, South Dakota, with which automobiles have made from 35 to 57 miles on a gallon of gasoline. It removes carbon and reduces spark plug trouble and overheating. It can be installed by any one in five minutes. Mr. Stransky wants distributors and is willing to send a sample at his own risk. Write him today.—Advertisement.

**MARVELOUS NEW
AUDIO TRANSFORMER**

adds a musical quality to any set far beyond anything you ever heard before. Karas Harmonik amplifies low, middle and high tones to the same big volume, eliminating distortion. Brings out vital harmonies and overtones of music. Price \$7.00. Write Karas Electric Co., Dept. A595, 4040 N. Rockwell St., Chicago.

WAIT FOR ANNOUNCEMENT OF BOSCH RADIO APPARATUS

Americ. Bosch Magneto Corporation
Main Office and Works: Springfield, Mass.
Branches: New York, Chicago, Detroit, San Francisco

Special Library of Information
on
**RADIO PATENTS
and
TRADE MARKS**

JOHN B. BRADY
Patent Lawyer
Ouray Building Washington, D. C.

Cable address: **RADIOPAT** Telephone: **Main 4806**

**THE ANDREWS
PADDLEWHEEL COIL**

A low-loss inductance. Improves tone quality and increases signal strength and selectivity. Price, with bracket \$3.00.
RADIO UNITS, INC.
1300 First Ave., Maywood, Ill.

YOUNG MEN—TURN YOUR SPARE HOURS INTO MONEY

Earn big profits, prizes, and awards selling RADIO NEWS, SCIENCE & INVENTION, THE EXPERIMENTER, and MOTOR CAMPER & TOURIST in your neighborhood. We train you as our salesman and pay you liberally for your time. Write at once and we will help you get started. M. BRIDWELL.

THE EXPERIMENTER PUBLISHING CO.,
53 PARK PLACE, NEW YORK CITY

4. *Taxation of Endowments and Regulation of Endowment Official Salaries.* These endowments are not, in perhaps most cases, now being used for the purposes which the founders had in mind. They are a drain on the resources of the country. No foundation which does not continue to enlist the financial approval of the public should continue in existence for more than the generation which created it. The taxes on foundations should be proportioned with this end in view, to lift the dead man's hand when rats shelter themselves beneath it, or when the end he sought is no longer for the common good.

5. *Making Our Universities Independent.* First by ruling as illegal bequests which make the university the servant of any trust or corporation. Next, by making pensions dependent solely upon fixed rules, service and vote of the university itself.

With these defences, provided and maintained, there is reason to hope for a long maintained age of invention. Without them we may confidently expect a long period of retrogression.

PRESERVATION OF ART OF INVENTING

All that I have written above has been because I am firmly convinced that if the decision of the Research Council to eliminate our Edisons, our Wrights and our Fords and the Patent Office, and to return to the "trade secret" system is successful (and it may well be, for amongst other factors which must be taken into consideration is the close connection of the head officials of the Research Council with the Russian Soviet; a "penetration from above," as it is phrased), then, as has happened in past ages from exactly the same cause, the progress of civilization will be halted for many years, even for many centuries.

One reason why it is hard to recover "great ages" is the penetrating growth of vested interests into their foundations, which is hard to remove. Another is that the arts and invention is an art as well as a science, require what may not irreverently be called a form of apostolic succession, because so much more is to be learned by seeing and assisting in the actual doing of the thing than is usually written.

It is for this reason that I am about to give along with the work which I did while with Edison, a description of his methods of working out problems and of his ways of looking at things, which are perhaps the large part of the art of invention.

Note.—"That no body of men can determine the true direction for growth" is a hard saying, but there is no difficulty in finding exemplifications. *E. g.*, a super-power committee, composed of most excellent engineers and business men, recently made their report, which had cost some millions of dollars. It was to the effect that the immense and cheap deposits of soft coal in Pennsylvania could not be used on account of lack of condensing water, and that buckwheat (three) anthracite, which they estimated to cost \$1.75 per ton, should be used, supplemented by elaborate hydraulic plants on the St. Lawrence and elsewhere.

This was the group reaction to the problem. The reaction of the individual inventor would have been radically different. He would have said: "No condensing water in Pennsylvania to use its coal? That does not sound right." He would have looked up the Weather Bureau charts and found that over five feet of rain falls annually in Pennsylvania. Then he would have said: "Where does it go to?" and found that, on account of de-forestation, it is not held and causes over \$15,000,000 damage per annum from floods, and that the State of Pennsylvania had under contemplation the expenditure of over \$100,000,000 for flood relief work. Then he would have said: "Why not combine the two problems, and utilize the flood reclama-

For Good Summer Radio Reception use **JEFFERSON** TUBE REJUVENATOR *keeps tubes like NEW!*

DON'T blame the weather for all summer radio troubles. . . . How are the tubes? All tubes, remember, grow weak with use—especially in summer when operated at higher voltage. Bring them back to full efficiency with the Jefferson Tube Rejuvenator! Takes only 10 minutes; attach to a convenient electric light socket. Used once a month, it **DOUBLES** and **TREBLES** the life of tubes! Quickly pays for itself in saving of tubes and batteries. It's wasteful to be without one; it's economy to own one. Takes large or small tubes—201-A, 301-A, UV-199, C-299. *Fully guaranteed.* At leading stores selling radio supplies. If your dealer can't supply you, send \$7.50 to

For Home Use

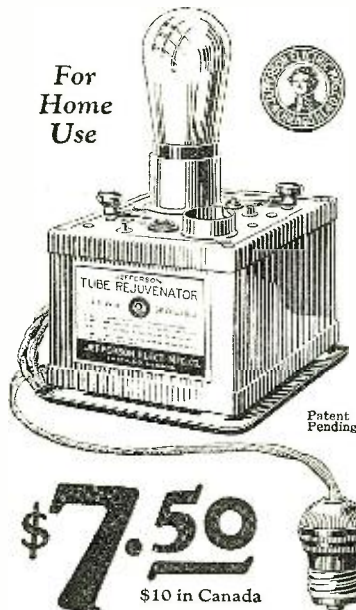

Patent Pending

\$7.50
\$10 in Canada

JEFFERSON ELECTRIC MFG. CO.
501 So. Green St., Chicago, Ill.

Makers of Jefferson Radio, Bell Ringing and Toy Transformers; Jefferson Spark Coils for Automobile, Stationary and Marine Engines; Jefferson Oil Burner Ignition Coils and Transformers.

LEARN THE CODE AT HOME

WITH THE OMNIGRAPH

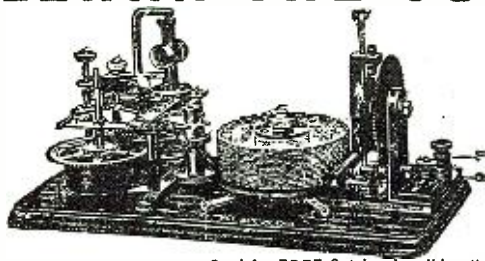

THE OMNIGRAPH Automatic Transmitter will teach you both the Wireless and Morse Codes—right in your own home—quickly, easily and inexpensively. Connected with Buzzer, Buzzer and Phone or to Sounder, it will send you unlimited messages, at any speed, from 5 to 50 words a minute. THE OMNIGRAPH is not an experiment. For more than 15 years, it has been sold all over the world with a money back guarantee. The OMNIGRAPH is used by several Depts. of the U.S. Govt.—in fact, the Dept. of Commerce uses the OMNIGRAPH to test all applicants applying for a Radio license. The OMNIGRAPH has been successfully adopted by the leading Universities, Colleges and Radio Schools.

Send for FREE Catalog describing three models. **DO IT TODAY.**

THE OMNIGRAPH MFG. CO., 15 HUDSON STREET, NEW YORK CITY
If you own a Radio Phone set and don't know the code—you are missing most of the fun

M & M INSULATORS



Made of hard rubber with brass center. 4" Lead in Insulator 50c; 10" Lead in Insulator, 80c; 20" Lead in Insulator for thick walls, \$1.50. Send for our big catalog of auto supplies and radio parts, sets and supplies.

Jobbers and Dealers Write for our special proposition, including attractive display board.

THE M & M CO., 500 Prospect Avenue, Cleveland, Ohio

for Improved Reception—

—build with **KIL-KO-PARTS**

Cut down interference and get stations you never heard before through scientific tube tuning. Booklet on Improved Reception sent for 2c stamp. Write Dept. RN-725.

D X INSTRUMENT CO. Harrisburg, Pa.

KIL-KO-PARTS

BAKELITE DIALS

are accurate in dimension and will not warp. Write for Booklet 24.



BAKELITE CORPORATION
247 Park Avenue, New York, N. Y.
Chicago Office: 636 West 22nd St.

25c

The Copy on All Newsstands

A FEW ADDITIONAL FEATURES OF THE JULY ISSUE

The Northward Trek.

By Richard K. Wood

Telling of the roads and camps from the south leading to northern localities.

Where to Camp.

By Charles B. Roth

Describing the most desirable places for the motor camper to visit, both far and near.

Camps and Camping.

By Ludwig Stanley Landmehl

Giving the experiences of a veteran camper with the questions pertaining to camp fare and shelter.

From Boston to Quebec, Montreal and the White Mountains.

By Mary Thornhill

In which an eastern tour is described and conditions indicated.

A Woman, A Car and More or Less Trouble.

By F. L. Allen

Indicating some of the things that a woman motorist should know.

Literary Landmarks for the Tourist Visiting Massachusetts.

By A. D. Mueller

Stating what and where the motorist from elsewhere will want to see of historic interest in the Old Bay State.

Motoring in British Columbia.

By Mrs. Stephen Nease

Describing the beauties of the Valley of the Okanagan.

Fourteen Miles Through Granite.

By Lewis Lemuel Thomas

The story of a new motor road through the High Sierras.

How To Build a Camping Car.

By Maristan Chapman

A set of plans and specifications by which the tourist may build his own camping car.

The Old Trail.

By A. E. Wilder

In which the author retraces the route followed by his father in pioneer days.

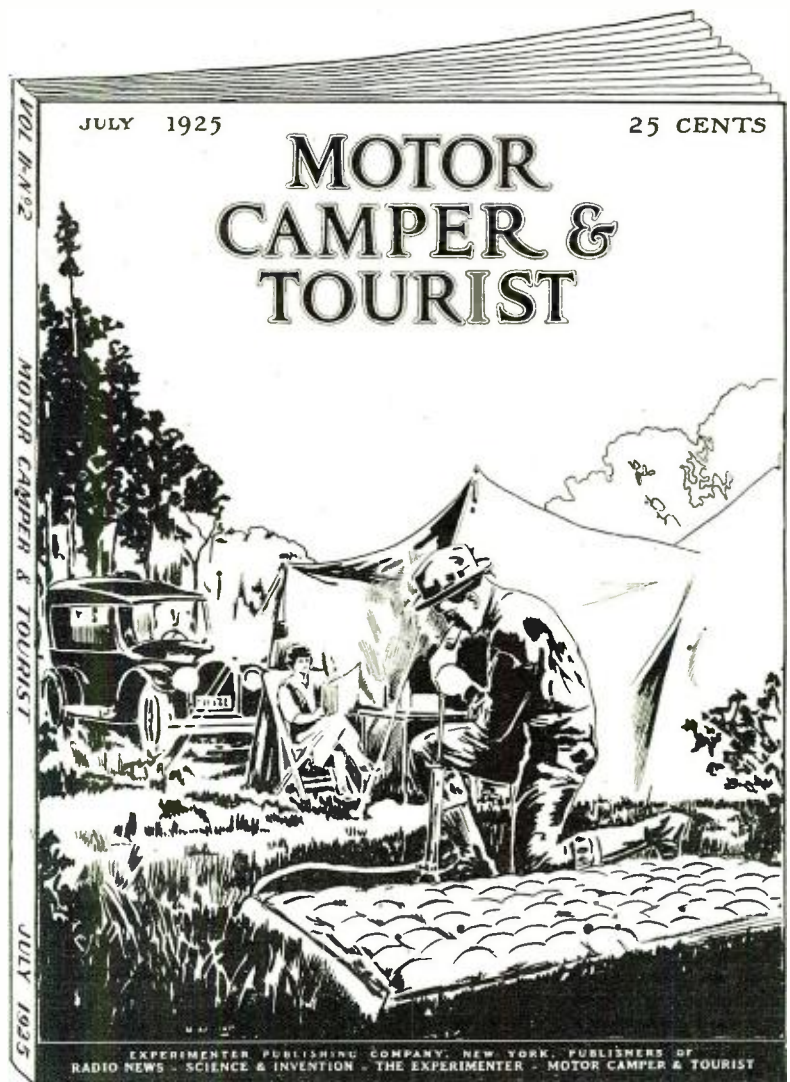

Touring in Illinois!

The July Issue of *Motor Camper & Tourist* contains a complete "Good Roads" map and a campsite map of the entire State of Illinois

Motor Camper & Tourist has 80 pages of valuable information for every motor tourist who contemplates a trip through the great state of Illinois.

There is only one way to motor tour satisfactorily and that is to know what roads to select, where to camp or stop, what to take along and lastly what to see.

To achieve these ends some tourists insist on half a dozen road maps, as many railroad maps and descriptive circulars and enough scenic books to fill a suitcase.

Yet the best and cheapest way to tour ideally and get the most from your trip is to use *Motor Camper & Tourist* the only national magazine for every motorist. It is a camp guide, a road guide, a scenic guide and a complete equipment and story magazine all in one.

ASK YOUR NEWSDEALER ABOUT IT TODAY!

Germott Publishing Co., Inc., Owners

Licensed Publishers—The Experimenter Publishing Co., Inc., 53 Park Place, New York, N. Y.

tion works for condensing water, which would be additionally an advantage to Pennsylvania, since it would make its coal deposits utilizable for such power purposes." He would make his calculations and find that all the quantities concerned came out well on the right side, and with provision for extensions many times greater. As regards the hydraulic extensions to supply the power deficiency of the "group" plan, the inventor would have said: "The importance of water transportation depends on the ratio of coastal area (i. e., area within say 50 miles of the coast) to total area. England and some other countries are substantially all coastal area, and are water transportation countries. But the United States is not. It is a rail country, and the hydraulic plants must be judged solely by their own production cost figure, which is greater than that of the coal-burning plants. Put the money into railway improvements, because the high capital and operating costs of the combined anthracite developments will tie you to high-cost power for half a century and cut you off from cheap power, electric heating, etc., which you might have from the bituminous power plants and power storage."

This will explain the saying, and there are reasons why it must always be true. One might say, like the countryman who could not see the city on account of the houses, that one cannot see the engineering on account of the engineers, but this would be neither fair nor true, for the engineers were not only capable but eminent, and the report shows good engineering. The truth is that something more than professional capacity is needed in dealing with questions of progress and a something which is the precise thing the Research Council has deliberately set about to eliminate from our civilization.

(To be continued)

(RADIO NEWS is not responsible for any opinions expressed in Dr. Fessenden's article.—Editor.)

I Want to Know
(Continued from page 80)

claim being its ability as a DX-er (long-distance receiver).

A satisfactory coil construction would be 10 turns of No. 18 annunciator wire for the untuned primary and 50 turns of No. 20 or 22 D.C.C. wire wound on a 3-inch tube. Wind both coils the same way and space the primary about 1/8 to 1/4 inch from the secondary. Any form of tickler coil may be used. About 20 turns of No. 26 or 28 D.C.C. wire on a 2 1/2-inch rotatable tube or ball will be satisfactory. The mechanical arrangement of the rotating element must be left to the ingenuity of the constructor.

Circuits Q, 2128-B and Q, 2128-D are extremely good for portable sets, or for sets located where conditions are not favorable for best reception. The use of substitute aerials in the form of electric light lines (a Ducon is used), fire escapes, inside-of-room aerials, wire fences, metal roofs, leader pipes, door-bell wiring, an insulated wire laid on the ground, an insulated wire buried one foot deep in the ground, and various other unusual conductors may often result in surprisingly good reception. If it is found very difficult to receive signals of readable intensity, try connecting any one of the convenient aerial systems mentioned above to the end of the secondary marked "G" of the variocoupler shown in tuning unit Q, 2128-D.

TUNED RADIO FREQUENCY

(2130) Mr. Richard Walters, Shanghai, China, asks:

Q. I. What is the Starr system of "tuned absorption," as used to prevent oscillation of tuned radio frequency circuits? It is desired to use one stage of push-pull audio frequency amplification with a phone jack so arranged that plugging the phones into the detector jack will automatically disconnect the push-pull amplifier tube filaments. When the head-phones are removed from the detector jack, the loud speaker should be automatically connected to the output of the amplifier.

As has been occasionally explained in these columns, the reason manufacturers try in so many ways to prevent oscillation without the use of a potentiometer or connecting the R.F. tube grid return leads to "A" positive, is two-fold. First, if a positive potential is put on the grid, i. e., if

No. 7 of a series of 10
"FILTER FACTS"
Follow them thru monthly

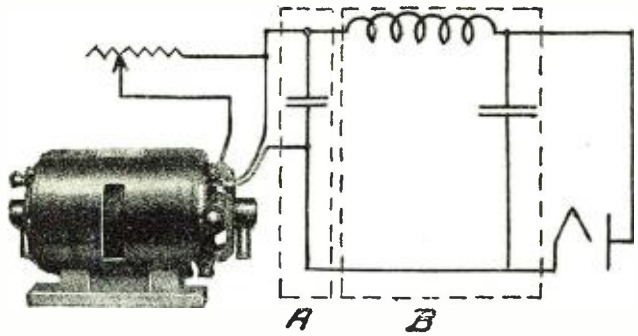

The T type of filter is one of the simplest and most economical of filters. For the generator it is ideal. Properly built it is the most effective of the "smoother types." That is, its filtering effect is not critical. It functions at all frequencies above the cut-off or resonant point. The lower this cut-off point and the sharper and more rapid the reduction beyond this point the better the filter is. This means that as large condensers and chokes as is practical, from an economical standpoint, should be used. A general idea of the functioning of this type may be obtained by considering it is to be divided into two parts. Part A is a condenser across the generator terminals. Its effect on the plate circuit is small. Its effect on the minute ripples in the generator is tremendous. It breaks them down, lowering them from a minute to a negligible amount. Part B takes what little disturbance is left and reduces it as explained in No. 5 of this series. One or two, one mfd. condensers and a one to ten henry choke makes a good filter for telegraphy and telephony work. Larger condensers and chokes will of course increase the filtering effect. The very best of results for telephony may be obtained with one to four one mfd. condensers and any standard "ESCO" motor generator set.

ELECTRIC SPECIALTY COMPANY

TRADE "ESCO" MARK

211 South Street

Stamford, Conn.

Real DX means maximum miles per watt, and that is what "ESCO" generators are built for.

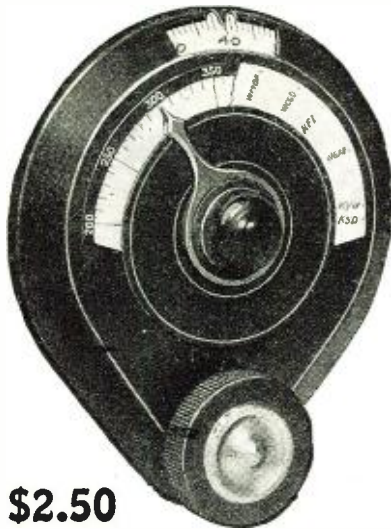

\$2.50

Exclusive features fully protected by patents pending.

The Better Tuning Control
Distinctively a B-T Product

Hairline Control, Easy Action, Simple Mounting.

No side strain or pull on shaft to wear out bearings or destroy alignment of your condenser or coil.

Reads 0 to 100 or 100 to 0,—settling the argument as to "Clockwise" or "Anti-Clockwise" instruments.

Registers dial numbers, wave-lengths or call letters.

Adds to the appearance of any set.

The New B-T Socket

You should know about the new B-T socket. You'll like it for its sensible design and careful construction. Send in your name and address for circulars describing this and other new B-T developments.

BREMER-TULLY MFG., Co.
532 S. Canal St. Chicago, Ill.

5000
RADIO DEALERS
buy from
HUDSON-ROSS
123 W. Madison St. Chicago
Send for dealers discount.

Learn **Electricity** Great Shops of Coyne—complete in 12 weeks on a vast amount of electrical equipment.
EARN \$200 to \$600 A MONTH
Enter anytime. Special limited offer. Auto and Radio course free. Send for big free book. Act now!
H. C. Lewis, Pres., COYNE ELECTRICAL SCHOOL, Dept. 594-B, 1300-1310 West Harrison St., Chicago, Ill.

THE NEW
UNCLE SAM
"CIGAR BOX" COIL
SMALLEST TUNING COIL IN THE WORLD



Size 2 7/8 x 2 1/2 In.
 This coil is so small it can be built in a cigar box. Just the thing for portable sets for vacations and outings.

When used with an Uncle Sam Antenna Coil, it gives a four tube tuned radio frequency set that will break through all locals, that has unbelievable selectivity and will get from coast to coast on a loud speaker.

FREE Ask your dealer or send us four cents in stamps for wiring diagrams of circuits in which these units can be used.

UNCLE SAM ELECTRIC CO.
 211 East 6th St., Plainfield, N. J.

the grid is "biased positive," "B" battery consumption is considerably increased. Second, the tuning is not then as sharp. In cheap sets the practice is to run the grid return lead to "A."

Consider the three tuned radio frequency transformers, having primaries and secondaries, as regular neutroformers designed for the Neurodyne circuit. One make has a secondary winding of 58 turns of No. 24 D.C.C. wire wound on a 2 3/4-inch tube. The primary consists of 6 turns of No. 26 D.C.C. wire wound on a 2 1/2-inch tube, which tube just fits inside the secondary. This primary may be re-wound to 12 turns. The absorption coil "A" is tuned by means of the .00004 mid. fixed condenser to a wave-length of about 250 meters. The "A" coils are made by winding 36 turns of No. 26 D.C.C. wire on a tube the same size as the one used for the primary winding, viz., 2 1/2 inches.

A Three-Range Receiver
 (Continued from page 32)

from 420 meters to 220 meters, the multi-point switch is moved to its second position and the dial of the variable condenser again revolved through the whole of its 180 degrees.

Then the real advantage of the set is made obvious. Instead of covering only the waves now in use over the center of the band, as is the case with a large majority of the commercial sets on the market, a third setting of the switch reduces the range of the set to 150 meters, where again the rotation of the condenser dial gives the final tuning.

As it was constructed in the RADIO NEWS LABORATORIES, the action of the set was all that could be desired. In one evening more than twenty-five stations were pulled in without the slightest difficulty.

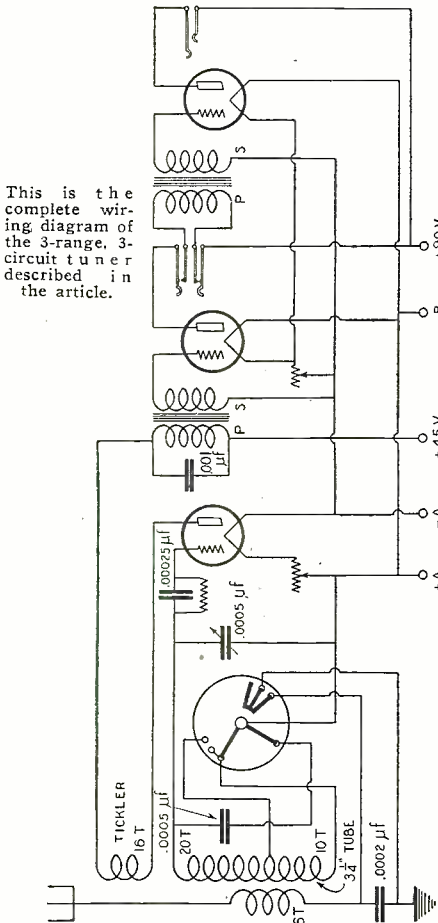

This is the complete wiring diagram of the 3-range, 3-circuit tuner described in the article.

Appended is a list of the calls of an evening's haul all on the loud speaker:
BROADCASTING
 WEAf, WNYC, WJZ, New York;

CARTER
New Portable Jack



75c

An original Carter Product. Just the thing to extend the head set or loud speaker on the porch for summer reception. Takes cord tips or wires.
 Any dealer can supply.
 In Canada—Carter Radio Co., Limited, Toronto.



Get the BIG PAY
RADIO Job

I'LL SHOW YOU HOW
 There are thousands more big pay fascinating radio positions open than there are men to fill them. I know what and where these real positions are—and I can qualify you, in a few weeks spare time, to fill one of these positions so you can earn **\$3,000 to \$10,000 a Year—Learn** I have successfully trained thousands of men in Electricity, Wireless and Radio for 15 Years. I can make you a full-fledged radio expert quickly; a titled, big pay man. You will learn how to install and maintain transmitting and receiving apparatus, professional and amateur, land and sea. You will know Radio thoroughly—and will get the bigger money because of your better, broader training. Send name and address for **Big Set Free!** a full outline of my course and how to get the big A. R. E. Twin Superdon Experimental Set absolutely FREE. Write me personally! Irwin J. Mendel's **AMERICAN RADIO ENGINEERS** 646 N. Michigan Ave., Dept. 95 Chicago



GEM TUBE
 A Guaranteed Radio Tube Within Reach of All



Every tube guaranteed. A tube for dollar or \$3 value. A trial order will convince you as it has thousands of others. Send your orders at once.
 Orders sent C.O.D. parcel post.
 Type.....401A **\$1.00**
 Type.....400
 Type.....499
 Type.....499A **1 EACH**

(with standard base)
 Dealers, Write for Discounts
GEM TUBE CO.
 Dept. N, 200 Broadway
 New York City

\$2.95 Out at last. "The Hawley." An unacid rechargeable "B" storage battery of 22 1/2 volts. Runs any set with more than ample power, up to 8 tubes. Easily recharged. This is not a parts battery but ready to use—no putting together or buying any extras. Chemical included and shipped separate. Closed top heavy shock-proof glass cells. Any special detector or amplifying voltage easily had. Patent pending. Special offer—4-22 1/2 volts (90 volts) \$10.00; 11 1/2 volts \$12.50; 13 1/2 volts \$14.75; 15 1/2 volts \$16.80. Knock-down kits may be had at still lower prices. Every battery and kit sold on direct understanding it may be returned in 30 days if clearer and better reception is not had and money plus transportation refunded. No its. ands. or buts to this offer. Further guaranteed 2 years. Send no money—simply pay expressman their cost on arrival plus the small transportation. Same day shipments. Write for my guarantee, testimonials, and literature. It's free and it's interesting. B. R. Smith, 31 Washington Ave., Danbury, Conn.

Young Men—
Turn Your Spare Hours Into Money

Earn big profits, prizes, and awards selling RADIO NEWS, SCIENCE & INVENTION, THE EXPERIMENTER, and MOTOR CAMPER & TOURIST in your neighborhood. We train you as our salesmen and pay you liberally for your time. Write at once and we will help you get started. M. BRIDWELL.

THE EXPERIMENTER PUBLISHING COMPANY
 53 Park Place, New York, N.Y.

Take This Book—Free
 Send Today!



36 Pages 7x10

Explains Easy Way of Assembling

Contains offers of Kits for a large number of best radio receivers, and accessories. Lowest Prices. Highest quality. Shipped on approval. No money in advance. — Transportation paid — Satisfaction Guaranteed. (See big ad. page 12).

YOU Need this Book

RADIO SPECIALTY COMPANY
 Kit Div. 679F, 245 Greenwich Street, New York City

The EARS OF RADIO



The success of your Radio depends upon what it gets from the air—a poor receiver an inferior program. Give your set a fair show, why pay good money for it, then handicap it with inferior ears. The Ears of Radio Aerial is properly constructed to receive from any point, and transmit to your set, with the greatest clearness both near and distant stations. A sensation in reception. Dealers write for prices.

RADEAR MFG. CO.,
 Box 251,
 Pinole, Calif.

50 FOOT AERIAL
 Price, postpaid \$3.50.
 Worth Double

Built on the same plan as the human ear, to receive electric impulses, in place of sound waves.

Burns
PERFECT REPRODUCER



Tone loud and pleasing. Handsome material and design.
 Black—\$22.50 Shell—\$25.00

AMERICAN ELECTRIC CO.
 State and 64th Sts. Chicago

Insure your copy reaching you each month. Subscribe to **RADIO NEWS**—\$2.50 a year. Experimenter Publishing Co., 53 Park Pl., N.Y.C.

WOR, Newark, N. J.; WHN WEBS, New York; WAHG, Richmond Hill, N. Y.; WMCA, WFBH, New York; WTAM, Cincinnati; WBAP, Fort Worth, Texas; WFBI, WSAI, Cincinnati; WTBE, WBZ, Springfield, Mass.; WLW, Cincinnati; KDKA, Pittsburgh, Pa.

AMATEUR

2CLG; 1ABA, Hyde Park, Mass.; 2HL; 2RK; 2KN; 9OA, Petersburg, Ind.; 9OK, St. Joseph, Mo.; 2AHR; 2AHN; 8AZY, Grampian, Pa.; 2EY; 2ABY; 3YZ; 2DBA.

Experts Discuss Broadcasting on 150 Meters

(Continued from page 18)

meet every fair and reasonable public demand. They will adopt any new development in radio science which will add to the effectiveness and pleasure of radio reception."

More to the point and of general interest is the statement of Paul B. Klugh, Secretary of the Executive Committee of the National Broadcasters' Association.

"This step," he said, "is the only logical one which may be taken for relief from the present situation confronting national broadcasting. As was said, it is almost impossible to open any waves above the present band without disorganizing radio in the whole world. But the lower bands may be used without any considerable difficulty.

"There is one point, however, which must be made clear. It is that the new bands which will be opened will be available to new stations and to older ones which desire to make the change. There is no general reallocation contemplated and, from all evidence now collected, none will be made. The problem is simply that of making room for more stations."

Again the cry may be raised that the amateur is being stifled, but it will be made only by those who are not cognizant of the present amateur practice. John L. Reinartz, probably the world's most famous amateur, said that at the present most amateurs are working in the neighborhood of eighty meters and that the change of the broadcasters would have, therefore, not the slightest effect upon them. He continued by saying that the operation of this class of station is so much more efficient at the lower lengths that the general movement in the amateur ranks is constantly toward the higher frequencies.

A Correction

The article in the June issue of RADIO NEWS on the Anti-Static device, invented by Dr. McCaa, has aroused considerable interest among our readers. It may be well for them to note that two very enlightening articles on the subject were published in Q.S.T. of February and March, of this year.

Needed Radio Inventions

(Continued from page 48)

possible with any degree of accuracy. However, in the straight-line frequency type condenser there is an advantage which has to a great extent been so far overlooked. In the ordinary types, if the dials are off two degrees at the upper end of the dial, they will be off several times that amount at the lower end—the higher frequencies. This follows a simple electrical law and has been known for years. On the other hand, with the straight-line frequency condensers, the deviation remains the same throughout the

Silver-Marsha

RADIO EQUIPMENT

116 South Wabash Avenue

Chicago



Parts for the Six-Tube Super-Autodyne

	Each
2 S-M 305-A S.L.F. Condensers.....	\$5.00
2 4" Moulded Dials, KK.....	1.00
1 U.S.L. 6 ohm Rheostat.....	1.00
1 U.S.L. 240 ohm Potentiometer.....	1.50
3 Insulated Top Binding Posts.....	.05
1 Carter 101 Jack.....	.70
1 Carter 102-A Jack.....	.80
1 S-M 211 Filter with Matched Tuning Capacity.....	8.00
2 S-M 210 Charted Intermediate Transformers.....	8.00
1 S-M 101B Coupling Unit.....	2.50
1 S-M 6-Gang Socket Shelf (536-201A) (537-199).....	10.80
2 Thordarson 3 1/2-1 Transformers.....	4.00
2 S-M .5 Condensers.....	.90
2 .00025 Condensers with Clips.....	.45
2 .002 Condensers.....	.40
1 .0075 Condensers.....	.75
2 .00025 Balancing Condensers.....	1.50
1 S-M .25 meg. Leak.....	.50
1 S-M 2 meg. Leak.....	.50
1 Carter No. 3 Jack Switch.....	1.15
1 Benjamin 8630 Switch.....	.30
1 S-M No. 701 Color Cable.....	1.00
1 pair Benjamin 8629 Shelf Brackets.....	.70
1 Bakelite Panel 7"x18"x3/16", drilled, grained and engraved.....	6.00
Spaghetti, Bus-Bar, Lugs, Screws, Nuts, etc.....	1.00

Total \$79.85

Plans and instructions for McMurdo Silver's Six-Tube Super-Autodyne Receiver Now Ready—Price 50c

Fans! Ask your dealer to show you S-M Products.

The Silver "Super-Autodyne" The Improved Super-Heterodyne

Again S-M engineering leads the field, just as it has since the first Silver Design was offered less than a year ago.

Not content with a seven-tube super-heterodyne, which has become the acknowledged standard of comparison with radio engineers and editors, McMurdo Silver, Assoc., I.R.E., has developed a six-tube receiver that will out-perform average seven- and eight-tube sets—the "Super-Autodyne."

Read the description of this remarkable radio achievement in the July issue of "Radio Broadcast." Read for yourself what Arthur H. Lynch, the editor, has to say about this receiver, with its unsurpassed intermediate amplifier, its non-radiating detector-oscillator, and distortionless audio amplifier. A set that will work through the strong locals with amazing selectivity and tonal clarity. Anyone can build and operate it.

Dealers! Our new illustrated dealers' catalog is ready. Send for it!

Uniformly Dependable!

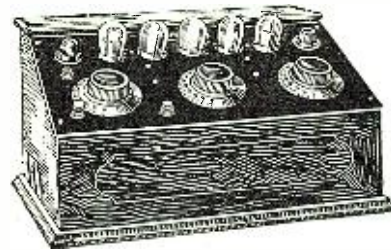

HERE is a Receiver that you can depend upon to behave itself when your friends come in.

JOS. W. JONES J-75 SET

5-Tube Radio Frequency Receiver; plain black dials and trim. Price, without tubes, batteries, headphones or aerial equipment.... **\$75**

JOS. W. JONES

TRADE MARK

Always dependable—always ready. Every model a triumph of precision in design and construction. Perfect balance. Amazing uniformity in

results. Volume—tone quality—hairbreadth selectivity. Priced within reach of every home.

Built of the Famous Jones Precision Parts.

Write NOW for literature and full particulars of these Standardized, Precision-Made Radio Receivers

JOS. W. JONES RADIO MFG. CO., 40-46 West 25th Street, New York

Branch Offices: Philadelphia — Boston — Chicago



"Lighting Fixtures"

READY TO HANG
(Direct from Manufacturer)
Completely wired including glassware.
Send for Catalogue No. 26.
(Just off the Press)
Special Proposition to Dealers
ERIE FIXTURE SUPPLY CO.
STATION R ERIE, PA.



CRESCENT LAMITE RESISTANCES

A Laboratory Product
for Distortionless Amplification
12,000, 48,000, 50,000, 100,000 Ohms. List \$1.50 each. Special Sizes to Order \$2.50 each.
Dealers write for discounts. When Better Resistances are made they will be Crescents.
Crescent Radio Supply Co., 1-5 Liberty St., Jamaica, N. Y.

The Great Hookup Magazine!

RADIO REVIEW

Reg. U.S. Pat. Off.

A Digest of the Latest Radio Hookups



IN EACH ISSUE AN INSTALLMENT OF
ILLUSTRATED
Radio Encyclopedia

The newest thing in radio publishing—A complete 100 page illustrated magazine containing hookups and constructional articles of every kind and description, gleaned from the entire radio press the world over.

No longer do you have to seek here or there for this or that hookup—Just refer to your file of the RADIO REVIEW. All the modern, useful circuits will be accumulated in this magazine and every hookup will be described in a constructional manner so as to aid the reader in the building of a complete receiver or transmitter.

RADIO REVIEW is absolutely impartial as it is published entirely in the interest of the reader. It is of the large magazine size, 9 by 12 inches, printed on fine magazine paper and profusely illustrated. It contains 100 pages of reading matter.

In Every Issue is a Supplement of
 One Installment of
S. Gernsback's Radio Encyclopedia

In every issue of RADIO REVIEW there will be a 16 page supplement of S. Gernsback's Radio Encyclopedia. This real encyclopedia of radio explains every word used in radio fully by means of photographs, drawings, charts or tables. The supplement is arranged in a convenient loose-leaf form so that it can be kept apart until you have accumulated all the installments.

Published by
The Conrad Co., Inc., 233 Fulton St., New York, N. Y.

35¢

For Sale At All
 Newsstands
 and
 Radio Stores

THE CONSRAD CO.,
 233 Fulton Street, New York.

Enclosed find \$3.50, for which enter my subscription to RADIO REVIEW for 12 issues.

Name..... Town.....

Street..... State.....

RADIO REVIEW—Greatest Hookup Magazine

whole scale. The application is obvious: If one condenser is slightly off, it is only necessary to place the necessary added capacity—which will always be small—in parallel with the main condenser, thus bringing all of them into the same tuning.

It is, of course, impossible to make each one have *exactly* the same capacity at the same setting, but considering the necessary broadness in tuning in one or more of the stages, it is seen at once that with the straight-line frequency condensers and careful adjustment, a single control may be used.

In this connection it must be remembered that tuning in the future must mean absolute stability and logability—to coin a word—and must remain always the same. If a station is brought in at one location at one time it must always come in at that same place, without any excessive vernier movements. The problem has had some discussion from time to time in the radio press, so it will not be set forth at any great length here.

AN IDÉE FIXE

While speaking of the single control idea: The notion of having a dial to turn represents a sort of fixed idea. It would be much easier to build a set to operate on one of a dozen or so stations. It could be easily managed by building one tuning inductance with a number of taps across it leading to a switching device of some kind, maybe nothing more than a dial with several points designated. Across each of these taps there could be placed a small vernier condenser for making the final adjustment. This should be made at the factory before the set is released for sale. Once adjusted, if the antenna coupling were loose enough, nothing else need be done.

The usual argument against this arrangement is that it does not allow for a wide variety of program. This criticism is, of course, quite senseless. Every set has a program range. Even with a super-heterodyne, programs from all over the country may not be enjoyed. After the transmitter is further than a certain distance—regulated by the set—the act of picking up a station becomes pure and simple DX. The program, if at all intelligible, is absolutely unenjoyable from the point of the esthetic. It ceases to be anything but a record for the set and the operator. And in at least 50 per cent. of the cases, the confirmed DX hunter is the sort of person who will build his own set, or if not build it completely, will tinker with it, adding and changing parts. So he is *per se*, a sort of mechanic and not at all the ordinary man who looks upon his radio set as a device for his entertainment, and not a machine with which to tinker.

To the man who is partly mechanic, the more controls there are the better he likes it, for they add to his belief in himself by making the set much more difficult for anyone who is unacquainted with it to operate. Whenever a friend drops in for the evening and attempts to tune the set, miserably failing to get anything but the nearby high-powered local, the owner of the multi-control affair swells his chest perceptibly, steps up to his formidable array of dials and proceeds to bring in a thousand or so miles with the loud speaker.

RADIO SET A FAMILY AFFAIR

But such a case is almost beside the point. More and more, the radio set is becoming a family affair, something for the enjoyment of every member of the household. Being such, it must necessarily be so constructed as to permit of operation by any member of the family. With such a simple set as the neutrodyne of today, the ordinary housewife, unaccustomed to mechanics of any sort, is at loss to tune in the program she desires. She may turn the dials and learn soon enough that they must be set at somewhere near the

FROST RADIO

Ask Your Neighbor

Apparatus of Paramount Quality

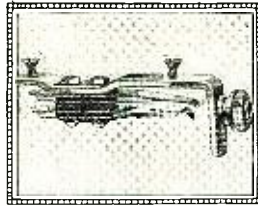

FROST-RADIO PAN-TAB JACKS
All types, 75c to \$1.00

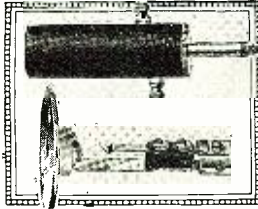

FROST-RADIO LOOP PLUG AND JACK
Complete \$1.50

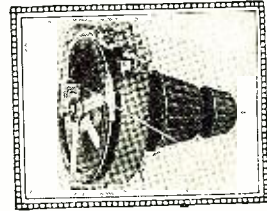

FROST-RADIO TUBE CONTROL UNITS
6, 25 or 35 ohm, \$1.75

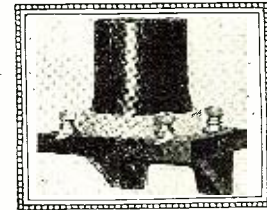

FROST-RADIO BAKELITE CUSHION SOCKETS
Single or 3 gang \$1.25 to \$3.25

YOU have only to examine an article of **FROST-RADIO** at the store of your neighborhood dealer to realize that here is apparatus built up to an ideal and not down to a price. Better design, more advanced construction, finer finish, all unite to make **FROST-RADIO** the greatest possible value for your money. See this apparatus today at your dealer's, or write for:

48-page Book of All FROST-RADIO FREE!

If you wish a copy of our free catalog of all items we manufacture, write Dept. 10F507 at address below



HERBERT H. FROST, Inc.
314-324 WEST SUPERIOR STREET, CHICAGO
NEW YORK CITY CLEVELAND KANSAS CITY LOS ANGELES
EXPORT OFFICE: 314 WEST SUPERIOR STREET, CHICAGO

The Success or Failure of Your Set Lurks in the Tubes

YOU SIMPLY CAN'T GET THE BEST RECEPTION UNLESS EVERY TUBE IS RIGHT

ONLY \$8.50

Unless every tube functions right, you are not getting the best results from your set. Tubes deteriorate in use. Loss of volume, failure to get distant stations, and countless hours of trouble hunting, all may result from one imperfect tube.

IN LESS THAN HALF A MINUTE THE STERLING HOME TUBE TESTER SHOWS YOU WHETHER A TUBE IS GOOD, FAIR OR POOR.

The Chart Tells The Story

Keep your receiver in first class working order with this simple, accurate and valuable instrument.

The Sterling Manufacturing Co.
2831-53 Prospect Ave., Dept. H.
Cleveland, Ohio.



Send for this instructive folder. IT'S FREE!



WHAT THE HOME TUBE TESTER DOES

Tells the amplifying ability of each tube.

Shows the plate amperage of any tube.

Suggests where to look for such troubles as open circuits in wiring, poor socket contacts, transformer open circuits, and defective "B" batteries.

Sterling
HOME TUBE TESTER

Reflectone

THE VIBRANT LOUD SPEAKER WITH THE GIANT VOICE

Registered
Only 5 Inches High—\$8.00
RICE & HOCHSTER
134 Washington Place New York City

FREE

Send your name and address with a stamp for the complete working drawings of the famous

ELGIN SUPER-REINARTZ

This is the set that has heard the many European stations—the set of unequalled selectivity and clarity.
ELGIN RADIO SUPPLY CO.
Dept. C, 207 E. Chicago St. Elgin, Ill.

TO THE RADIO DEALER

Let us explain how you can make the sale of our publications a worth while, well paying part of your business. Write now and prepare for the Fall and Winter trade.

Experimenter Publishing Company

53 Park Place

::

::

::

New York City

The New Radio Stamp Fad

Here is the DX Radio Stamp Album just like the ones we owned in our youth, in which were placed the rare stamps of the countries of the world. Some were hard to get, some couldn't be purchased for love or money; but the fun of the hobby was the seeking of rare stamps and the eventual possession. So it will be with the DX Radio Stamp Album. There will probably be some stamps you will

never be able to own, but there will be many you will be proud to have and be able to show to other radio enthusiasts. It's an interesting game. Below the Album is shown the "Proof of Reception Cards" of which a generous supply is furnished with each Album. A dime placed in the hole in the card and sent to the station you heard brings back a stamp for your Album.

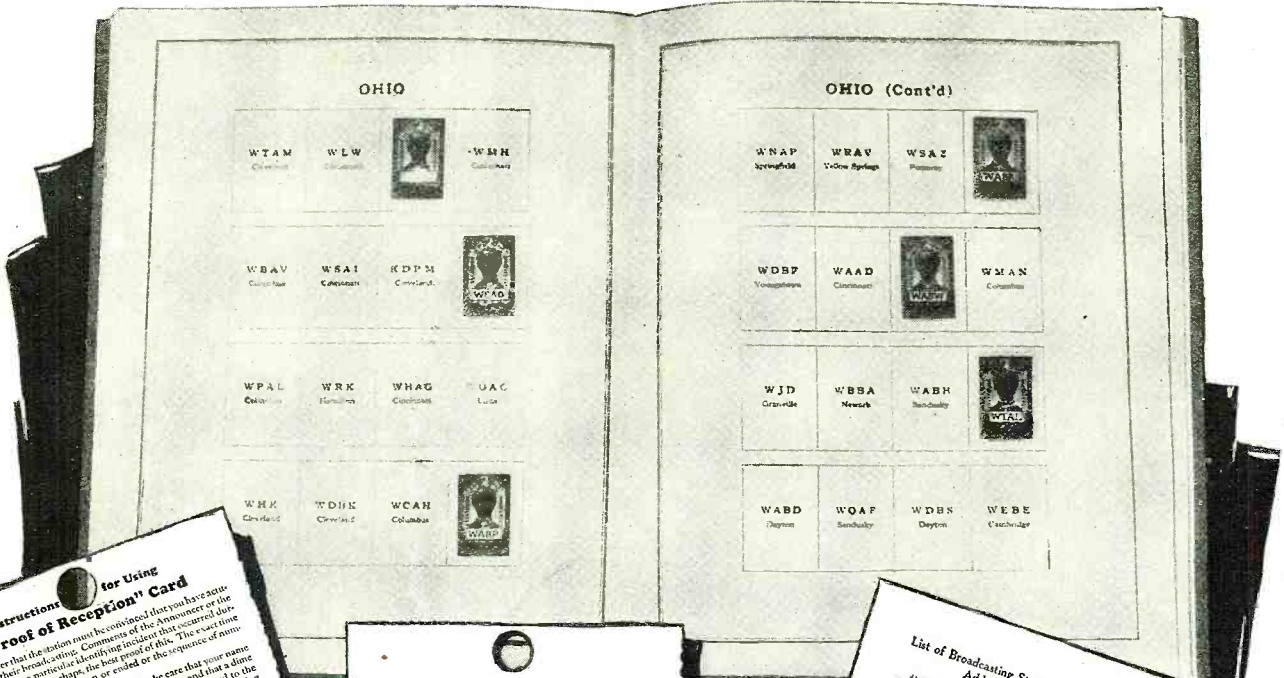

Instructions for Using "Proof of Reception" Card

Remember that the station must be convinced that you have actually heard their broadcasting. Comments of the Announcer or the mention of some particular identifying incident that occurred during the number of days, perhaps, the last proof of this. The exact time that a particular number began or ended or the sequence of numbers that other events.

Fill out all the blanks on the card and take care that your name and address are clearly written where they belong and that a stamp of the broadcasting station is pasted in a envelope addressed to the station is included in your **EKKO** stamp album.

On _____ at _____ I heard your station broadcasting the following:

By mail stamp album and place in **EKKO** stamp album.

Proof of Reception Card

This card is supplied for your convenience in communicating with the broadcasting station to procure an **EKKO** stamp supplied by that station.

It is necessary that definite information, other than that appearing in public print, be given to determine the authenticity of your claim.

My set is: Crystal Tube
 Tube Name of Mfr. _____

The broadcasting station will appreciate your filling in the above as well as listing, in the order in which you prefer them, the following kinds of broadcasting:

Orchestra classical Lectures
 Orchestra jazz Political
 Song classical Shows
 Song popular Theatrical Productions

At what hours do you use your set to broadcast?

List of Broadcasting Stations With Call Letters, Owner and Address-Revised

All the present lists and all the following stations have had the opportunity to be listed and will be listed in the order in which they are listed in the present list. The stations listed in this list are those that have been listed in the present list. The stations listed in this list are those that have been listed in the present list.

CALL LETTERS	OWNER	ADDRESS
WABC	Radio City Music Co.	127 W. 47th St., N.Y.C.
WABD	Dayton	Dayton, Ohio
WABE	Cincinnati	Cincinnati, Ohio
WABF	Yonkers	Yonkers, N.Y.
WABH	Sanbury	Sanbury, Conn.
WABJ	Atlantic City	Atlantic City, N.J.
WABK	Dayton	Dayton, Ohio
WABL	Dayton	Dayton, Ohio
WABM	Dayton	Dayton, Ohio
WABN	Cincinnati	Cincinnati, Ohio
WABO	Cincinnati	Cincinnati, Ohio
WABP	Cincinnati	Cincinnati, Ohio
WABQ	Cincinnati	Cincinnati, Ohio
WABR	Cincinnati	Cincinnati, Ohio
WABS	Cincinnati	Cincinnati, Ohio
WABT	Cincinnati	Cincinnati, Ohio
WABU	Cincinnati	Cincinnati, Ohio
WABV	Cincinnati	Cincinnati, Ohio
WABW	Cincinnati	Cincinnati, Ohio
WABX	Cincinnati	Cincinnati, Ohio
WABY	Cincinnati	Cincinnati, Ohio
WABZ	Cincinnati	Cincinnati, Ohio
WABA	Cincinnati	Cincinnati, Ohio
WABB	Cincinnati	Cincinnati, Ohio
WABC	Cincinnati	Cincinnati, Ohio
WABD	Cincinnati	Cincinnati, Ohio
WABE	Cincinnati	Cincinnati, Ohio
WABF	Cincinnati	Cincinnati, Ohio
WABG	Cincinnati	Cincinnati, Ohio
WABH	Cincinnati	Cincinnati, Ohio
WABI	Cincinnati	Cincinnati, Ohio
WABJ	Cincinnati	Cincinnati, Ohio
WABK	Cincinnati	Cincinnati, Ohio
WABL	Cincinnati	Cincinnati, Ohio
WABM	Cincinnati	Cincinnati, Ohio
WABN	Cincinnati	Cincinnati, Ohio
WABO	Cincinnati	Cincinnati, Ohio
WABP	Cincinnati	Cincinnati, Ohio
WABQ	Cincinnati	Cincinnati, Ohio
WABR	Cincinnati	Cincinnati, Ohio
WABS	Cincinnati	Cincinnati, Ohio
WABT	Cincinnati	Cincinnati, Ohio
WABU	Cincinnati	Cincinnati, Ohio
WABV	Cincinnati	Cincinnati, Ohio
WABW	Cincinnati	Cincinnati, Ohio
WABX	Cincinnati	Cincinnati, Ohio
WABY	Cincinnati	Cincinnati, Ohio
WABZ	Cincinnati	Cincinnati, Ohio
WABA	Cincinnati	Cincinnati, Ohio
WABB	Cincinnati	Cincinnati, Ohio
WABC	Cincinnati	Cincinnati, Ohio
WABD	Cincinnati	Cincinnati, Ohio
WABE	Cincinnati	Cincinnati, Ohio
WABF	Cincinnati	Cincinnati, Ohio
WABG	Cincinnati	Cincinnati, Ohio
WABH	Cincinnati	Cincinnati, Ohio
WABI	Cincinnati	Cincinnati, Ohio
WABJ	Cincinnati	Cincinnati, Ohio
WABK	Cincinnati	Cincinnati, Ohio
WABL	Cincinnati	Cincinnati, Ohio
WABM	Cincinnati	Cincinnati, Ohio
WABN	Cincinnati	Cincinnati, Ohio
WABO	Cincinnati	Cincinnati, Ohio
WABP	Cincinnati	Cincinnati, Ohio
WABQ	Cincinnati	Cincinnati, Ohio
WABR	Cincinnati	Cincinnati, Ohio
WABS	Cincinnati	Cincinnati, Ohio
WABT	Cincinnati	Cincinnati, Ohio
WABU	Cincinnati	Cincinnati, Ohio
WABV	Cincinnati	Cincinnati, Ohio
WABW	Cincinnati	Cincinnati, Ohio
WABX	Cincinnati	Cincinnati, Ohio
WABY	Cincinnati	Cincinnati, Ohio
WABZ	Cincinnati	Cincinnati, Ohio
WABA	Cincinnati	Cincinnati, Ohio
WABB	Cincinnati	Cincinnati, Ohio
WABC	Cincinnati	Cincinnati, Ohio
WABD	Cincinnati	Cincinnati, Ohio
WABE	Cincinnati	Cincinnati, Ohio
WABF	Cincinnati	Cincinnati, Ohio
WABG	Cincinnati	Cincinnati, Ohio
WABH	Cincinnati	Cincinnati, Ohio
WABI	Cincinnati	Cincinnati, Ohio
WABJ	Cincinnati	Cincinnati, Ohio
WABK	Cincinnati	Cincinnati, Ohio
WABL	Cincinnati	Cincinnati, Ohio
WABM	Cincinnati	Cincinnati, Ohio
WABN	Cincinnati	Cincinnati, Ohio
WABO	Cincinnati	Cincinnati, Ohio
WABP	Cincinnati	Cincinnati, Ohio
WABQ	Cincinnati	Cincinnati, Ohio
WABR	Cincinnati	Cincinnati, Ohio
WABS	Cincinnati	Cincinnati, Ohio
WABT	Cincinnati	Cincinnati, Ohio
WABU	Cincinnati	Cincinnati, Ohio
WABV	Cincinnati	Cincinnati, Ohio
WABW	Cincinnati	Cincinnati, Ohio
WABX	Cincinnati	Cincinnati, Ohio
WABY	Cincinnati	Cincinnati, Ohio
WABZ	Cincinnati	Cincinnati, Ohio
WABA	Cincinnati	Cincinnati, Ohio
WABB	Cincinnati	Cincinnati, Ohio
WABC	Cincinnati	Cincinnati, Ohio
WABD	Cincinnati	Cincinnati, Ohio
WABE	Cincinnati	Cincinnati, Ohio
WABF	Cincinnati	Cincinnati, Ohio
WABG	Cincinnati	Cincinnati, Ohio
WABH	Cincinnati	Cincinnati, Ohio
WABI	Cincinnati	Cincinnati, Ohio
WABJ	Cincinnati	Cincinnati, Ohio
WABK	Cincinnati	Cincinnati, Ohio
WABL	Cincinnati	Cincinnati, Ohio
WABM	Cincinnati	Cincinnati, Ohio
WABN	Cincinnati	Cincinnati, Ohio
WABO	Cincinnati	Cincinnati, Ohio
WABP	Cincinnati	Cincinnati, Ohio
WABQ	Cincinnati	Cincinnati, Ohio
WABR	Cincinnati	Cincinnati, Ohio
WABS	Cincinnati	Cincinnati, Ohio
WABT	Cincinnati	Cincinnati, Ohio
WABU	Cincinnati	Cincinnati, Ohio
WABV	Cincinnati	Cincinnati, Ohio
WABW	Cincinnati	Cincinnati, Ohio
WABX	Cincinnati	Cincinnati, Ohio
WABY	Cincinnati	Cincinnati, Ohio
WABZ	Cincinnati	Cincinnati, Ohio
WABA	Cincinnati	Cincinnati, Ohio
WABB	Cincinnati	Cincinnati, Ohio
WABC	Cincinnati	Cincinnati, Ohio
WABD	Cincinnati	Cincinnati, Ohio
WABE	Cincinnati	Cincinnati, Ohio
WABF	Cincinnati	Cincinnati, Ohio
WABG	Cincinnati	Cincinnati, Ohio
WABH	Cincinnati	Cincinnati, Ohio
WABI	Cincinnati	Cincinnati, Ohio
WABJ	Cincinnati	Cincinnati, Ohio
WABK	Cincinnati	Cincinnati, Ohio
WABL	Cincinnati	Cincinnati, Ohio
WABM	Cincinnati	Cincinnati, Ohio
WABN	Cincinnati	Cincinnati, Ohio
WABO	Cincinnati	Cincinnati, Ohio
WABP	Cincinnati	Cincinnati, Ohio
WABQ	Cincinnati	Cincinnati, Ohio
WABR	Cincinnati	Cincinnati, Ohio
WABS	Cincinnati	Cincinnati, Ohio
WABT	Cincinnati	Cincinnati, Ohio
WABU	Cincinnati	Cincinnati, Ohio
WABV	Cincinnati	Cincinnati, Ohio
WABW	Cincinnati	Cincinnati, Ohio
WABX	Cincinnati	Cincinnati, Ohio
WABY	Cincinnati	Cincinnati, Ohio
WABZ	Cincinnati	Cincinnati, Ohio
WABA	Cincinnati	Cincinnati, Ohio
WABB	Cincinnati	Cincinnati, Ohio
WABC	Cincinnati	Cincinnati, Ohio
WABD	Cincinnati	Cincinnati, Ohio
WABE	Cincinnati	Cincinnati, Ohio
WABF	Cincinnati	Cincinnati, Ohio
WABG	Cincinnati	Cincinnati, Ohio
WABH	Cincinnati	Cincinnati, Ohio
WABI	Cincinnati	Cincinnati, Ohio
WABJ	Cincinnati	Cincinnati, Ohio
WABK	Cincinnati	Cincinnati, Ohio
WABL	Cincinnati	Cincinnati, Ohio
WABM	Cincinnati	Cincinnati, Ohio
WABN	Cincinnati	Cincinnati, Ohio
WABO	Cincinnati	Cincinnati, Ohio
WABP	Cincinnati	Cincinnati, Ohio
WABQ	Cincinnati	Cincinnati, Ohio
WABR	Cincinnati	Cincinnati, Ohio
WABS	Cincinnati	Cincinnati, Ohio
WABT	Cincinnati	Cincinnati, Ohio
WABU	Cincinnati	Cincinnati, Ohio
WABV	Cincinnati	Cincinnati, Ohio
WABW	Cincinnati	Cincinnati, Ohio
WABX	Cincinnati	Cincinnati, Ohio
WABY	Cincinnati	Cincinnati, Ohio
WABZ	Cincinnati	Cincinnati, Ohio
WABA	Cincinnati	Cincinnati, Ohio
WABB	Cincinnati	Cincinnati, Ohio
WABC	Cincinnati	Cincinnati, Ohio
WABD	Cincinnati	Cincinnati, Ohio
WABE	Cincinnati	Cincinnati, Ohio
WABF	Cincinnati	Cincinnati, Ohio
WABG	Cincinnati	Cincinnati, Ohio
WABH	Cincinnati	Cincinnati, Ohio
WABI	Cincinnati	Cincinnati, Ohio
WABJ	Cincinnati	Cincinnati, Ohio
WABK	Cincinnati	Cincinnati, Ohio
WABL	Cincinnati	Cincinnati, Ohio
WABM	Cincinnati	Cincinnati, Ohio
WABN	Cincinnati	Cincinnati, Ohio
WABO	Cincinnati	Cincinnati, Ohio
WABP	Cincinnati	Cincinnati, Ohio
WABQ	Cincinnati	Cincinnati, Ohio
WABR	Cincinnati	Cincinnati, Ohio
WABS	Cincinnati	Cincinnati, Ohio
WABT	Cincinnati	Cincinnati, Ohio
WABU	Cincinnati	Cincinnati, Ohio
WABV	Cincinnati	Cincinnati, Ohio
WABW	Cincinnati	Cincinnati, Ohio
WABX	Cincinnati	Cincinnati, Ohio
WABY	Cincinnati	Cincinnati, Ohio
WABZ	Cincinnati	Cincinnati, Ohio
WABA	Cincinnati	Cincinnati, Ohio
WABB	Cincinnati	Cincinnati, Ohio
WABC	Cincinnati	Cincinnati, Ohio
WABD	Cincinnati	Cincinnati, Ohio
WABE	Cincinnati	Cincinnati, Ohio
WABF	Cincinnati	Cincinnati, Ohio
WABG	Cincinnati	Cincinnati, Ohio
WABH	Cincinnati	Cincinnati, Ohio
WABI	Cincinnati	Cincinnati, Ohio
WABJ	Cincinnati	Cincinnati, Ohio
WABK	Cincinnati	Cincinnati, Ohio
WABL	Cincinnati	Cincinnati, Ohio
WABM	Cincinnati	Cincinnati, Ohio
WABN	Cincinnati	Cincinnati, Ohio
WABO	Cincinnati	Cincinnati, Ohio
WABP	Cincinnati	Cincinnati, Ohio
WABQ	Cincinnati	Cincinnati, Ohio
WABR	Cincinnati	Cincinnati, Ohio
WABS	Cincinnati	Cincinnati, Ohio
WABT	Cincinnati	Cincinnati, Ohio
WABU	Cincinnati	Cincinnati, Ohio
WABV	Cincinnati	Cincinnati, Ohio
WABW	Cincinnati	Cincinnati, Ohio
WABX	Cincinnati	Cincinnati, Ohio
WABY	Cincinnati	Cincinnati, Ohio
WABZ	Cincinnati	Cincinnati, Ohio
WABA	Cincinnati	Cincinnati, Ohio
WABB	Cincinnati	Cincinnati, Ohio
WABC	Cincinnati	Cincinnati, Ohio
WABD	Cincinnati	Cincinnati, Ohio
WABE	Cincinnati	Cincinnati, Ohio
WABF	Cincinnati	Cincinnati, Ohio
WABG	Cincinnati	Cincinnati, Ohio
WABH	Cincinnati	Cincinnati, Ohio
WABI	Cincinnati	Cincinnati, Ohio
WABJ	Cincinnati	Cincinnati, Ohio
WABK	Cincinnati	Cincinnati, Ohio
WABL	Cincinnati	Cincinnati, Ohio
WABM	Cincinnati	Cincinnati, Ohio
WABN	Cincinnati	Cincinnati, Ohio
WABO	Cincinnati	Cincinnati, Ohio
WABP	Cincinnati	Cincinnati, Ohio
WABQ	Cincinnati	Cincinnati, Ohio
WABR	Cincinnati	Cincinnati, Ohio
WABS	Cincinnati	Cincinnati, Ohio
WABT	Cincinnati	Cincinnati, Ohio
WABU	Cincinnati	Cincinnati, Ohio
WABV	Cincinnati	Cincinnati, Ohio
WABW	Cincinnati	Cincinnati, Ohio
WABX	Cincinnati	Cincinnati, Ohio
WABY	Cincinnati	Cincinnati, Ohio
WABZ	Cincinnati	Cincinnati, Ohio
WABA	Cincinnati	Cincinnati, Ohio
WABB	Cincinnati	Cincinnati, Ohio
WABC	Cincinnati	Cincinnati, Ohio
WABD	Cincinnati	Cincinnati, Ohio
WABE	Cincinnati	Cincinnati, Ohio
WABF	Cincinnati	Cincinnati, Ohio
WABG	Cincinnati	Cincinnati, Ohio
WABH	Cincinnati	Cincinnati, Ohio
WABI	Cincinnati	Cincinnati, Ohio
WABJ	Cincinnati	Cincinnati, Ohio
WABK	Cincinnati	Cincinnati, Ohio
WABL	Cincinnati	Cincinnati, Ohio
WABM	Cincinnati	Cincinnati, Ohio
WABN	Cincinnati	Cincinnati, Ohio
WABO	Cincinnati	Cincinnati, Ohio
WABP	Cincinnati	Cincinnati, Ohio
WABQ	Cincinnati	Cincinnati, Ohio
WABR	Cincinnati	Cincinnati, Ohio
WABS	Cincinnati	Cincinnati, Ohio
WABT	Cincinnati	Cincinnati, Ohio
WABU	Cincinnati	Cincinnati, Ohio
WABV	Cincinnati	Cincinnati, Ohio
WABW	Cincinnati	Cincinnati, Ohio
WABX	Cincinnati	Cincinnati, Ohio
WABY	Cincinnati	Cincinnati, Ohio
WABZ	Cincinnati	Cincinnati, Ohio
WABA	Cincinnati	Cincinnati, Ohio
WABB	Cincinnati	Cincinnati, Ohio
WABC	Cincinnati	Cincinnati, Ohio
WABD	Cincinnati	Cincinnati, Ohio
WABE	Cincinnati	Cincinnati, Ohio
WABF	Cincinnati	Cincinnati, Ohio
WABG	Cincinnati	Cincinnati, Ohio
WABH	Cincinnati	Cincinnati, Ohio
WABI	Cincinnati	Cincinnati, Ohio
WABJ	Cincinnati	Cincinnati, Ohio
WABK	Cincinnati	Cincinnati, Ohio
WABL	Cincinnati	Cincinnati, Ohio
WABM	Cincinnati	Cincinnati, Ohio
WABN	Cincinnati	Cincinnati, Ohio
WABO	Cincinnati	Cincinnati, Ohio
WABP	Cincinnati	Cincinnati, Ohio
WABQ	Cincinnati	Cincinnati, Ohio
WABR	Cincinnati	Cincinnati, Ohio
WABS	Cincinnati	Cincinnati, Ohio
WABT	Cincinnati	Cincinnati, Ohio
WABU	Cincinnati	Cincinnati, Ohio
WABV	Cincinnati	Cincinnati, Ohio
WABW	Cincinnati	Cincinnati, Ohio
WABX	Cincinnati	Cincinnati, Ohio
WABY	Cincinnati	Cincinnati, Ohio
WABZ	Cincinnati	Cincinnati, Ohio
WABA	Cincinnati	Cincinnati, Ohio
WABB	Cincinnati	Cincinnati, Ohio
WABC	Cincinnati	Cincinnati, Ohio
WABD	Cincinnati	Cincinnati, Ohio
WABE	Cincinnati	Cincinnati, Ohio
WABF	Cincinnati	Cincinnati, Ohio
WABG	Cincinnati	Cincinnati, Ohio
WABH	Cincinnati	Cincinnati, Ohio
WABI	Cincinnati	Cincinnati, Ohio
WABJ	Cincinnati	Cincinnati, Ohio
WABK	Cincinnati	Cincinnati, Ohio
WABL	Cincinnati	Cincinnati, Ohio
WABM	Cincinnati	Cincinnati, Ohio
WABN	Cincinnati	Cincinnati, Ohio
WABO	Cincinnati	Cincinnati, Ohio
WABP	Cincinnati	Cincinnati, Ohio
WABQ	Cincinnati	Cincinnati, Ohio
WABR	Cincinnati	Cincinnati, Ohio
WABS	Cincinnati	Cincinnati, Ohio
WABT	Cincinnati	Cincinnati, Ohio
WABU	Cincinnati	Cincinnati, Ohio
WABV	Cincinnati	Cincinnati, Ohio
WABW	Cincinnati	Cincinnati, Ohio
WABX	Cincinnati	Cincinnati, Ohio
WABY	Cincinnati	Cincinnati, Ohio
WABZ	Cincinnati	Cincinnati, Ohio
WABA	Cincinnati	Cincinnati, Ohio
WABB	Cincinnati	Cincinnati, Ohio
WABC	Cincinnati	Cincinnati, Ohio
WABD	Cincinnati	Cincinnati, Ohio
WABE	Cincinnati	Cincinnati, Ohio
WABF	Cincinnati	Cincinnati, Ohio
WABG	Cincinnati	Cincinnati, Ohio
WABH	Cincinnati	Cincinnati, Ohio
WABI	Cincinnati	Cincinnati, Ohio
WABJ	Cincinnati	Cincinnati, Ohio
WABK	Cincinnati	Cincinnati, Ohio
WABL	Cincinnati	Cincinnati, Ohio
WABM	Cincinnati	Cincinnati, Ohio
WABN	Cincinnati	Cincinnati, Ohio
WABO	Cincinnati	Cincinnati, Ohio
WABP	Cincinnati	Cincinnati, Ohio
WABQ	Cincinnati	Cincinnati, Ohio
WABR	Cincinnati	Cincinnati, Ohio

same number—but when it comes to noting the desired program in the paper, with the wave-length of the station at the head, and then correlating the two facts so that she may set the dials at a number corresponding to the wave-length of the desired station, there is not one in fifty able to do it—at least, not until the husband or brother has first neatly logged the set.

So the manufacturer who wishes to build a good business upon the foundation of an excellent home set, available for the man or woman who knows nothing about the intricacies of electrons, space currents and plate impedances, will construct his set of such parts and according to such design as will enable the operator, simply to set a button or switch at a given point and bring in the desired station.

Even with the large number of broadcasting stations in operation today, there are few localities where any set but the best super-heterodyne will bring in more than a dozen stations at ample loud speaker volume for the programs to be enjoyed as a real esthetic pleasure. This point must be stressed. With the possible exception of New York and Chicago, there are few places in the country where more than a couple of stations are within easy loud speaker range of the ordinary set.

And as a merchandising problem, sets must be made more and more efficient, so that the man of small means will be able to enjoy at least all the local programs with loud speaker reproduction. This is to stress the fact that efficiency must not be sacrificed for the sake of selling points. They must become more efficient instead of less so.

The receiver is of the utmost importance, from point of view of art and remuneration for the inventor.



There is no substitute for experience

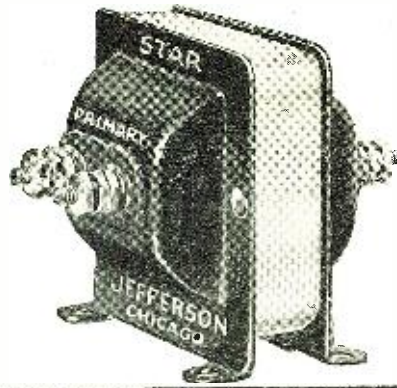

Made by the world's largest manufacturers of small transformers

JEFFERSON RADIO TRANSFORMERS

Jefferson Transformers will clearly reproduce tones from the lowest note of the bass drum to the highest note of the violin, with greatest amplification and complete absence of distortion.

JEFFERSON ELECTRIC MANUFACTURING CO.

501 South Green Street Chicago, Ill.

Makers of Jefferson Radio Tube Rejuvenators; Radio, Bell Ringing and Toy Transformers; Jefferson Spark Coils for Automobile, Stationary and Marine Engines; Jefferson Oil Burner Ignition Coils and Transformers.

For That Clearer Reception and Maximum Results



"CeCo"
Tipless
Radio Tubes



5 V. Made with Brass



3 V. Bakelite Base



3 V. Standard Base

A Quality Product
Approved by Leading Authorities

Excellent Detectors and Unexcelled Amplifiers for Any Type Receiver. They afford the utmost in radio reception. Noted for their long life and efficiency. Made of best materials in an up-to-date factory and scientifically tested. Not the Cheapest, but the Best. Backed by the good will of the satisfied users and by a Guarantee which is an Absolute Guarantee.

BEST BY TEST

Providence Distributing Co., EXCLUSIVE DISTRIBUTORS C. E. Mfg. Co., 702 Eddy St., Prov. R. I.

All About Verniers

(Continued from page 56)

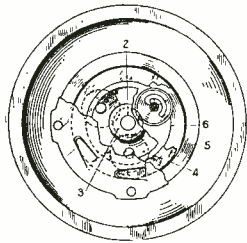
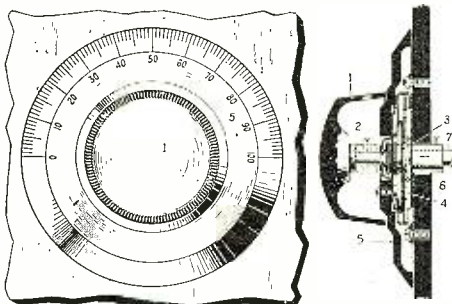

Dial (1) turns shaft (2), at the same time turning wheel (3). This engages by friction the annular wheels (6), which carry the dial (5) and the condenser shaft.

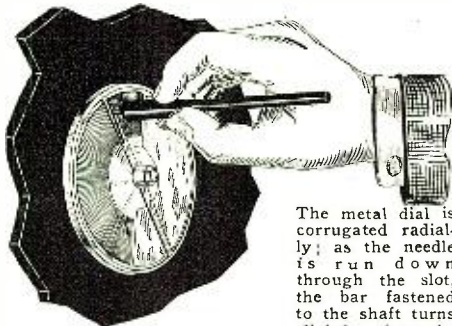

The metal dial is corrugated radially; as the needle is run down through the slot, the bar fastened to the shaft turns slightly, since the slot is cut at a small angle.

Young Men— Turn Your Spare Hours Into Money!

Earn big profits, prizes, and awards selling RADIO NEWS, SCIENCE & INVENTION, THE EXPERIMENTER and MOTOR CAMPER & TOURIST in your neighborhood. We train you as our salesmen and pay you liberally for your time. Write at once and we will help you get started.

M. BRIDWELL.

THE EXPERIMENTER PUBLISHING CO.

53 Park Place, New York City

3 TUBE LOUD SPEAKING

only \$29.95

FULLY GUARANTEED LONG DISTANCE RADIO

Users everywhere report Miraco Tuned Radio Frequency sets get programs coast to coast; outperform sets 3 times as costly. Send for proof they are radio's most amazing values. One tube guaranteed, completely assembled long distance outfit, only \$14.35. Three tube (above), \$29.50. Five tube \$75

SEND POSTAL TODAY for latest bulletins and special offer. It will interest you

MIDWEST RADIO CORP'N
Pioneer Builders of Sets
480-N. E. 8th St., Cincinnati, Ohio

AGENTS DEALERS
Our proposition's a winner. Write.

MIRACO RADIO GETS 'EM COAST TO COAST

BODINE BASKET-WEAVE LOOP AERIAL

Gives winter reception with no reduction in distance. Folding Loop. Ask your dealer.

BODINE ELECTRIC CO.
2250 West Ohio Street Chicago, Ill.

OPPORTUNITY AD-LETS

Follow these advertisements every month. Reliable advertisers from all over the country offer their most attractive specials in these columns.

Classified advertising rate twenty-two cents a word for each insertion. Ten per cent discount for 6 issues, 20 per cent discount for 12 issues. Name and address must be included at the above rate. Cash should accompany all classified advertisements unless placed by an accredited advertising agency. No advertisement for less than 10 words accepted.

Objectionable or misleading advertisements not accepted. Advertisements for the September issue must reach us not later than July 1st.

CIRCULATION LARGER THAN THAT OF ANY OTHER RADIO PUBLICATION

EXPERIMENTER PUBLISHING CO., INC., 53 Park Place, New York, N. Y.

Agents Wanted

Agents Wanted in every city and town to sell standard radio apparatus. Attractive discounts given. If interested write us at once stating age and radio experience. Wilmington Electrical Specialty Co., Inc., 405 Delaware Ave., Wilmington, Delaware.

Agents—Write for Free Samples. Sell Madison "Better-Made" Shirts for large manufacturer direct to wearer. No capital or experience required. Many earn \$100 weekly and bonus. Madison Mfgs., 501 Broadway, New York.

Big Money and fast sales. Every owner buys gold initials for his auto. You charge \$1.50; make \$1.35. Ten orders daily easy. Write for particulars and free samples. American Monogram Co., Dept. 133, East Orange, N. J.

Guaranteed Genuine Gold Leaf Letters anyone can put on store windows. Large profits, enormous demand. Free samples. Metallic Letter Co., 422 N. Clark, Chicago.

Can You Sell? All-wool, union made, tailored-to-measure suits for \$19.75. Universal Tailors, K99 Bedford Street, Boston.

Big money and fast sales, every owner buys gold initials for his auto. You charge \$1.50 make \$1.44 profit. 10 orders daily easy. Samples and information free. World Monogram Co., Dept. 27, Newark, N. J.

Agents—Our new Household Cleaning Device washes and dries windows, sweeps, cleans walls, scrubs, mops. Costs less than brooms. Over half profit. Write Harper Brush Works, 160 3rd St., Fairfield, Iowa.

Earn \$10 daily silvering mirrors, plating, refinishing metalware, headlights, chandeliers, bedsteads. Outfits furnished. Bolanger-Debie Laboratories, 1133 Broadway, New York.

Easy Money Applying gold initials, monograms on automobiles. Anyone can do it. Simply transferred from paper; takes 5 minutes. Make \$1.50, cost 5c. Samples free. Hanco, 325C Harrison, Boston, Mass.

Agents—Liberal Commission on Beautiful Loudspeaker Radio Table. Direct Factory Representation. Send for illustrated circular. Radio Specialty Associates, 1227 Michigan Ave., Chicago.

Books

Books Wanted: "Signaling Through Space Without Wires" by Lodge; and "Magic-Stage Illusions and Scientific Diversions," by Albert A. Hopkins. State price. Address H. W. Seor, c/o Science and Invention, 53 Park Place, New York City.

Business Opportunities

\$50 a Week Evenings. Mail Order Business. Booklet tells how. Sample and plan 25c. Free—9 articles worth \$3. E. Bradford Co., Shawnee, Okla.

Make \$100 Weekly in Spare Time. Sell what the public wants—long distance radio receiving sets. Two sales weekly pays \$100 profit. No big investment, no canvassing. Sharpe of Colorado made \$955 in one month. Representatives wanted at once. This plan is sweeping the country—write today before your county is gone. Ozarka, 813 Washington Blvd., Chicago.

Advertise, hundred magazines, three issues, 10c word. Pennell Company, Covington, Kentucky.

Chemistry

Learn Chemistry at home. Dr. T. O'Connor Sloane, noted educator and scientific authority will teach you. Our home study correspondence course fits you to take a position as chemist. See our full page ad on page 17 of this issue. Chemical Institute of New York, 66 W. Broadway, New York City.

Educational

Used Correspondence School courses save over half. Bargain catalogue 1000 courses free. Used courses bought. Students' Exchange, Dept. A, 47 West 42d St., New York.

Correspondence Courses. All Schools. Lowest prices. Terms. Catalog free. Mention subject. Economy Educator Service, 440-F Sansome, San Francisco.

Esperanto

Esperanto. Easiest and most successful method for studying the Esperanto Language ever published. Booklet of sample pages illustrated by 145 illustrations sent on request. Benson School of Esperanto, Inc., 20 Mercer St., Newark, N. J.

For Advertisers

24 Words—355 Rural Weeklies \$14.20. Admeyer, 4112-R Hartford, St. Louis.

For Rent

For Rent—Store or Department. 100% Richmond, Virginia, 100%. For a live radio firm will rent a department or store. Each situated in the heart of the best retail shopping center, surrounded by our leading department stores and women's specialty shops and chain stores. Long lease, reasonable rent. Immediate possession. On one of the heaviest traffic bearing blocks in the city. For full particulars write, Gordon E. Strause, Broad at Seventh, Richmond, Virginia.

For Sale

Generators, 30 v. input, output 300 v. \$8. Wood, 151 E. 108, N. Y.

Games and Entertainment

Magic tricks. Catalog free. B. Penner, 2101 Jefferson, Louisville, Ky.

Help Wanted

Detectives Needed Everywhere. Travel. Experience unnecessary. Write George Wagner, former Government Detective, 1908 Broadway, N. Y.

Earn \$25 weekly, spare time, writing for newspapers, magazines. Experience unnecessary. Copyright book free. Press Syndicate, 972, St. Louis, Mo.

Men to build radio sets in spare time. Leon Lambert, 595-H Kaufman Bldg., Wichita, Kansas.

Detectives needed everywhere; large salaries; free particulars; write National Headquarters, 188 East 79th, New York.

Insects Wanted

Why not spend Spring, Summer and Fall gathering butterflies, insects? I buy hundreds of kinds for collections. Some worth \$1 to \$7 each. Simple outdoor work with my instructions, pictures, price-list. Send 10 cents (not stamps) for my illustrated Prospectus before sending butterflies. Mr. Sinclair, Dealer in Insects, Box 1424, Dept. 10, San Diego, California.

Instruction

Learn Chemistry at Home. Dr. T. O'Connor Sloane, noted educator and scientific authority, will teach you. Our home study correspondence course fits you to take a position as chemist. See our full page ad on page 17 of this issue. Chemical Institute of New York, 66 W. Broadway, New York City.

Machinery and Tools

Special machine builders, tool and die makers. Inventors' models, production work of all kinds. Dept. C. Quality Hardware & Machine Co., Ravenswood and Thorndale Avenues, Chicago, Ill.

Miscellaneous

Beautiful registered bull pups cheap. Bulldogs. 501 Rockwood, Dallas, Texas.

For Your Ford—Automatic Re-Atomizer prevents foul plugs, carbon formation reduced. More mileage, saves gas and oil. Puts new life in your car. Sent prepaid only \$1.00. Specialty Mfg. Co., Hatfield, Mass.

\$166 quickly developed \$2,500 assets. No canvassing. Legitimate. Kerr Company, Monadnock Bldg., San Francisco, Calif.

For Sale or Rent. Splendidly situated factory. Water power, Electric generator, Good help. About 75 miles from New York City and on Main Line of Erie. Most desirable for Radio manufacture, offers great advantages in economical production. Address Box 276, Honesdale, Pa.

Motorcycles, Bicycles

Don't Buy a Bicycle Motor Attachment until you get our catalog and prices. Shaw Mfg. Co., Dept. 6, Galesburg, Kansas.

Old Money Wanted

\$2 to \$500 each paid for hundreds of Old or Odd Coins. Keep all old money, it may be very valuable. Send 10c for New Illustrated Coin Value Book, 1st. Guaranteed prices. Get posted. We pay Cash. Clarke Coin Company, 11 Street, Leffoy, N. Y.

Patent Attorneys

Inventors—Should write for our Free Guide Books and "Record of Invention Blank" before disclosing inventions. Send model or sketch of your invention for our Free Inspection and Instructions. Radio, Electrical, Chemical, Mechanical and Trademark experts. Terms reasonable. Victor J. Evans & Co., 929 Ninth, Washington, D. C.

Patents. Send drawing or model for examination and report as to patentability. Advice and booklet free. Highest references. Best results. Promptness assured. Watson E. Coleman, Patent Lawyer, 644 G Street, N. W., Washington, D. C.

Patents—Send for form "Evidence of Conception" to be signed and witnessed. Form, fee schedule, information free. Lancaster and Allwine, Registered Patent Attorneys in United States and Canada, 269 Ouray Bldg., Washington, D. C.

Patents for Inventions. Long experience, highest grade work, rates reasonable, best references. Advice as to patentability. Wm. Ashley Kelly, 41 Park Row, New York.

Inventions patented or no charges. Patent Service, Suite 810, 20 East Jackson Blvd., Dept. R, Chicago.

Inventors—who derive largest profits know and heed certain simple but vital facts before applying for patents. Our book Patent-Sense gives those facts; free. Write Lacey & Lacey, 631 F St., Washington, D. C. Established 1869.

Patents

Inventions Commercialized. Patented or unpatented. Write Adam Fisher Mfg. Co., 278 Enright, St. Louis, Mo.

Unpatented Ideas Can Be Sold. I tell you how and help you make the sale. Free particulars (Copyrighted). Write W. T. Greene, 804 Jenifer Building, Washington, D. C.

Personal

Lonely Hearts—Exchange letters; make interesting new friends in our jolly club. Eva Moore, Box 908, Jacksonville, Florida. Enclose stamp.

Lonely—Join Our Club. Make friends everywhere. Particulars free. Write Mrs. Matthews, Box 26, Oakland, Calif.

Exchange Cheery Letters with new friends. Write Betty Lee, Inc., Box 820 City Hall Station, New York City. Stamp appreciated.

Lonesome—Join our club—make acquaintances everywhere. Big illustrated book with descriptions and photos, sent in plain wrapper for ten cents. Bonafide Co., Dept. 58, Kansas City, Mo.

Printing Outfits and Supplies

Print your own cards, stationery, circulars, paper, etc. Complete outfits \$8.85; Job Presses \$12.85; Rotary \$150. Print for others, big profit. All easy, rules sent. Write for catalog presses, type, paper, etc. Press Company, A-13, Meriden, Conn.

Rare Coins

United States Flying Eagle Cent and Bargain Price List 10c. M. Arcey, Box 183, Muskogee, Oklahoma.

Radio

Boys! Don't Overlook This. The "Rasco" Baby Detector, Greatest detector ever brought out with molded base. Fully adjustable. See former advertisements in this publication, or our catalog. Detector with Galena Crystal, complete 50c, the same detector with Radiocite Crystal, 75c prepaid. Send for yours today. Radio Specialty Company, 96-98 Park Place, New York City.

Ivory Radio Panel: Grained white "Trorlyte" makes most beautiful set of all. Guaranteed satisfactory. Any size 3-16" thick sent prepaid 3c per square inch. Sample free. E. P. Halton, Dept. N, 614 Main St., Fort Worth, Texas.

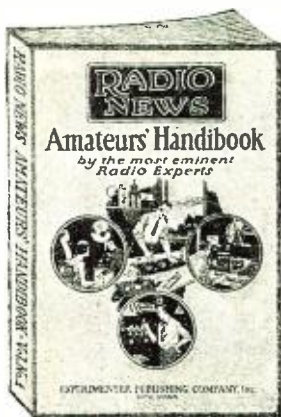

Just the Book You Wanted "RADIO NEWS" Amateurs' Handibook

By the Most Eminent Radio Experts

Chock full of radio constructive and instructive articles from cover to cover. Written by foremost radio authorities, in plain everyday language which everyone can understand. Sections include articles on Receiving Sets and Sundry Apparatus, Transmitters and Accessories, Radio Theory, Vacuum Tube Data and Practical Hints for the Amateur. A book which also serves as a ready reference and should find a place in the library of every amateur. It contains 224 pages and over 375 illustrations, diagrams, and photographs, bound in a multi-colored heavy board.

On sale at all leading radio stores. If your dealer cannot supply you, send a dollar bill and book will be forwarded to your postpaid.

EXPERIMENTER
PUBLISHING CO., Inc.
53 Park Place New York

Radio (Continued)

Attention!—50 Vacuum tube hook-ups. The greatest collection of vacuum tube circuits ever brought under two covers at such insignificant cost. These diagrams will be found in the great "Kaseo" catalog, which contains raw materials and parts in a greater profusion than any other catalog. 15c in stamps, or coin, will bring the catalog to you. Radio Specialty Co., 96-98 Park Place, New York City.

Edison Elements 5c per pair. Co-operative Merchandise Co., Chelsea, Mass.

2650 Miles Distance with one tube. Any Novice understands our simplified instructions. Big free booklet tells the story. Vesro Radio Co., Box 117RN, Oakland, Calif.

Elleite Super Radio Receiver. No Tubes, A or B Batteries. Operates Speaker, Clarity, Distance. Write Elleite Radio Co., Box 193, Buffalo, N. Y.

McWilliams super-sensitive selenium cells are excellent for voice modulation and experiments with the amplification of Radio by light rays. Hook up for Radio furnished free with each cell. Electric Beam Grader Products Co., Ithaca, Michigan.

Make your Neutrodyne Low Loss. Wind the coils on the Tap Collapsible Metal Coil form. Send one dollar for Form and full instructions. Jap Coil Form Co., 141 Merrimac St., Pittsburg, Pa.

For Sale—New Raven Superheterodyne Kit. \$18.00. H. Klappenbach, Johnson City, Tex.

Before you buy a radio write me for "What radio experts know but don't tell you." Leon Lambert, 595 Wichita, Kansas.

Make battery plates—Big demand. Complete formulas and directions, reasonable. Research Chemist, Care Battery Man, Terre Haute, Ind.

English Firm Requires American Radio Parts. Old established Wholesale Radio Company having large connections throughout Great Britain with jobbers, require exclusive buying agencies. English, French and American references. Write Wholesale Wireless Co., 103, Farringdon Road, London, England.

Distributors—Tremendous Money Maker. Revolutionary Electric Soldering Iron. Operates from Dry Cells or Storage Battery. Solders Instantly. Complete Kit retails \$2.00 only. Rapid Fire Sales, Protected Territory. Write Regent Mfg., 18 Trinity Bldg., Boston, Mass.

Salesmen Wanted

A Salesman wanted in every town or city within 25 miles of a broadcasting station to sell Radiogen, the complete radio receiving set that retails for \$2.50. With Radiogen, there is nothing else to buy—the outfit includes the Radiogen receiving apparatus, 1,000 ohm phone, and aerial outfit. The cheapest radio outfit on the market—yet as practical as the most expensive. Big money to the right men. Send \$2.00 for sample outfit. The Radiogen Corp., 66-R West Broadway, New York City.

Lightning Strange battery compound. Charges discharged batteries instantly. Eliminates old method entirely. Gallon free to agents. Lightning Co., St. Paul, Minn.

Skat Sales Agents Wanted. All or Part Time for Skat Hand Soap, Metal Polish, etc. Strictly Commission. The Skat Company, Hartford, Conn.

Scenery to Rent

Settings for Opera, Plays, Minstrels. Plush Drops. Address Amelia Grain, Philadelphia.

Song Writers

Songwriters: Let me furnish the music for your songs, guaranteeing you absolute satisfaction. Copyrights secured. Submit your scripts for estimate and free advice. Walter W. Newcomer, 1674 Broadway, New York.

Telegraphy

Telegraphy—Both Morse and Wireless taught thoroughly. Big salaries. Wonderful opportunities. Expenses low; chance to earn part. School established fifty years. Catalog free. Dodge's Institute, Cour St., Valparaiso, Ind.

Wanted to Buy

Full Value Paid for Old Gold, Jewelry, Watches, Diamonds, crowns, bridges, dental gold, silver, platinum, gold or silver ore; magnetite, old false teeth. Packages returned if our offer is not satisfactory. United States Smelting Works (The Old Reliable) 39 So. State St., Dept. 16, Chicago, Ill.

To the Radio Dealer

Let us explain how you can make the sale of our publications a worth while, well paying part of your business. Write now and prepare for the Fall and Winter trade.

Experimenter Publishing Company
53 Park Place New York City

One Radio Book Everyone Reads

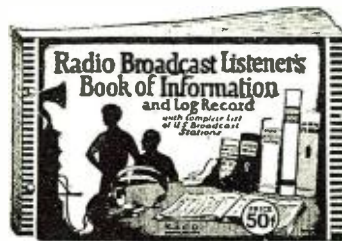

The Radio Broadcast Listener's Book of Information and Log Record

is not only a complete, practical book of those essential Radio facts that everyone who owns a radio should know, but it is also a handy log record for those who want to keep a record of the stations they receive. The book is enclosed in a handsome two-color cover, bound in Loose-leaf fashion, so that new pages can be inserted if necessary. It contains 80 pages, each one containing information more valuable than the last.

The following is a brief summary of the information contained in this book:

- Information for the Broadcast Listener:
- Vacuum Tube Table:
- Meter Wave Lengths:
- Radio Batteries:
- Wireless Code Chart:
- Station Log Chart:

Complete list of Broadcast Stations of the United States, giving Power, wave length, and Time of Operation each day of the week. Log Sheets for tabulating the dial settings of the stations you receive on your radio. Size of Book, 6 in. by 9 in., with handsome 2-color cover.

Postage **PRICE 50¢** Paid

Published by
The E. I. COMPANY
Sole Distributors
The Conrad Co.
233 Fulton Street
New York, N. Y.

The Bradleystat handles ALL tubes without change of connections.

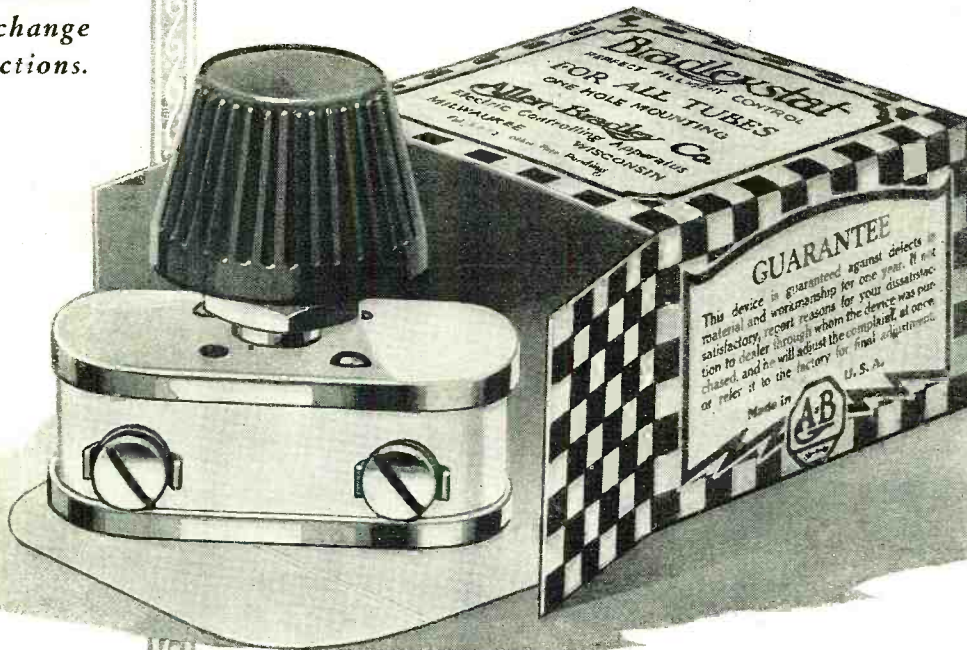

Bradleystat
PERFECT FILAMENT CONTROL

Two columns of graphite discs provide stepless, noiseless control.

Range of control is from 1/4 to 100 ohms, sufficient for all tubes without change of connections.

One-hole mounting for panels. Table mounting for baseboards.

Extremely compact. Easily substituted for wire rheostats.

\$1.85

In Canada, \$2.50

There are many rheostats
—but only one Bradleystat

The smooth, noiseless, stepless control of the Bradleystat is the outstanding characteristic that places this remarkable filament rheostat in the front rank of perfect radio devices. Many attempts have been made to duplicate Bradleystat performance by using substitutes for the scientifically-treated graphite discs, but without success.

It is not strange that the Bradleystat maintains its supremacy among radio rheostats! It was developed by engineers who have designed graphite disc rheostats for over twenty years. Have you improved your set with Bradleystats? Try one, tonight.

Allen-Bradley Co.

Electric Controlling Apparatus
287 Greenfield Avenue
MILWAUKEE, WISCONSIN

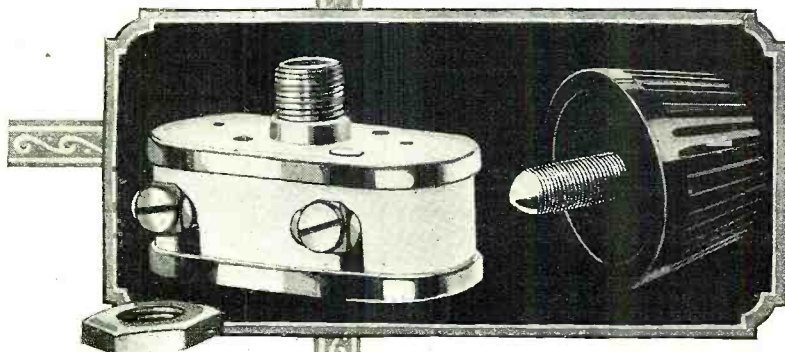

MAIL THIS COUPON

Please send me descriptive literature on the Bradleystat and other Allen-Bradley radio devices.

Name

Address

GILES PRINTING CO., LONG ISLAND CITY

ZENITH

TRADE MARK REG.

RADIO

→LONG DISTANCE←
TRADE MARK REG.

While MacMillan Charts the Arctic Zenith Broadcasts to the World!

Between Alaska and the North Pole stretches an unexplored area one million square miles in extent—the last remaining “blind spot” on the face of the globe.

Over this vast area will fly, this summer, two great planes of the amphibian type, piloted by U.S. Navy air pilots and equipped with the most highly perfected scientific apparatus obtainable by the United States Government. This entire expedition, which has rightly been described as the greatest expedition of modern times, is under the direction of Commander Donald B. MacMillan.

The purpose of the expedition is the study and photographic charting of this unknown area—and—new tests in radio transmission and reception of unparalleled importance. The section to be explored has never been heard from by radio. Communication will of necessity be *day-light* communication, for in this area the days are six months long.

On an expedition representing so

great a risk, both in capital and human life, only the *best* in radio equipment can possibly command a place. Once more, therefore, MacMillan chooses ZENITH exclusively, both for his ships and for the two great planes flying across uncharted seas of ice.

Thus, while the world awaits reports from this greatest expedition of modern times, it is worth remembering that the only way these reports can possibly be transmitted is by Zenith radio.

Never in all your life, it is safe to say, will you require of a radio set such *outstanding* performance as MacMillan requires of ZENITH in the Arctic. But can you imagine greater satisfaction than to know that your receiving set can *deliver* such performance, any time it's called upon to do so?

Call this evening at your nearest ZENITH dealer, and ask him for a demonstration.

Zenith Radio Corporation
310 S. Michigan Ave., Chicago, Ill.



Super-Zenith IX

Costs More—But Does More

THE complete Zenith line ranges in price from \$100 to \$475.

With either Zenith 3R or Zenith 4R, satisfactory reception over distances of 2,000 to 3,000 miles is readily accomplished, using any *ordinary loud speaker*. Models 3R and 4R licensed under Armstrong U. S. Patent No. 1,113,149. They are NON-RADIATING.

Zenith 4R - \$100
Zenith 3R - \$175

The new Super-Zenith is a six-tube set with a new, unique, and really different patented circuit, controlled exclusively by the Zenith Radio Corporation. It is NOT regenerative.

SUPER-ZENITH VII—Six tubes—2 stages tuned frequency amplification—detector and 3 stages audio frequency amplification. Installed in a beautifully finished cabinet of solid mahogany—44½ inches long, 16½ inches wide, 10½ inches high. Compartments at either end for dry batteries. Price (exclusive of tubes and batteries)..... **\$240**

SUPER-ZENITH VIII—Same as VII except—console type. Price (exclusive of tubes and batteries)..... **\$260**

SUPER-ZENITH IX—Console model with additional compartments containing built-in Zenith loud speaker and generous storage battery space. Price (exclusive of tubes and batteries)..... **\$355**

SUPER-ZENITH X—Contains built-in, patented, Super-Zenith Duo-Loud Speakers (harmonically synchronized *twin* speakers and horns), designed to

reproduce both high and low pitch tones otherwise impossible with single-unit speakers. Price (exclusive of tubes and batteries) **\$475**

All Prices F. O. B. Factory

Zenith Radio Corporation
Dept. 7-B
310 S. Michigan Avenue, Chicago, Illinois
Gentlemen:
Please send me illustrated literature about Zenith Radio.

Name.....
Address.....



Whether You Buy or Build These Parts Assure Efficiency

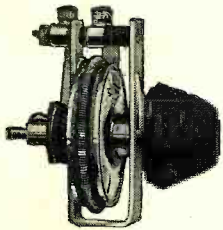

C-H Rheostats

For all tubes. Four Ohm. with or without vernier for detector and amplifier tubes, respectively. Thirty ohms for 1/4 ampere tubes. C-H Potentiometer of similar design.

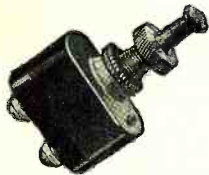

C-H Radio Switch

The original radio switch with the patented and exclusive C-H snap mechanism that assures long life and perfect operation.

The next time you are in a dealer's store, look over the sets he has on display! It may surprise you to note how many of them are built with Cutler-Hammer parts.

Rheostats, sockets, switches—you'll find them all—for manufacturers, too, have found through careful testing, what radio enthusiasts have learned through experience. Results are obtained only with efficient apparatus, and the C-H trademark is a reliable guide to successful reception.

If your set is Cutler-Hammer equipped, whether the product of your own hands or a huge factory, it is basically *right*—one of which you may justly be proud.

THE CUTLER-HAMMER MFG. CO.
Member Radio Section, Associated Manufacturers of Electrical Supplies
Works: Milwaukee and New York



Low Loss Socket

The departure in socket design that set fans talking everywhere. Silvered contacts—Bakelite and Thermoplas construction. Insist on the socket with the ORANGE shell.

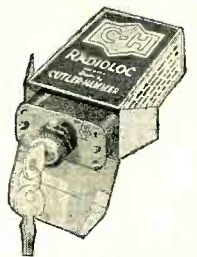

C-H Radioloc

The new lock for your radio set. Protects tubes and batteries from meddling fingers and the children. Carry the key on your ring.

CUTLER-HAMMER